



Stock Replacement Products

FASCO

THE REPLACEMENT MOTOR AND BLOWER SPECIALIST
CATALOG 45



See pages 119-184

Now Available
Premium Efficiency Motors from



Trust FASCO for all your replacement motor, blower and accessory needs!

For nearly 100 years, FASCO has been designing and manufacturing motors and blowers that have become some of the most respected in the industry.

FASCO now proudly offers even more great products to meet the demands of any job and any budget!



SSC



ARKTIC 142



ARKTIC 59



GE Commercial Motors

By Regal-Beloit

Life-Line



FASCO

FASCO, Genteq and Morrill Motors are trademarks of Regal-Beloit Corporation.

GE is a trademark of General Electric Company and is used under license to Regal-Beloit Corporation



DESCRIPTION	PAGE
Alphanumeric Index	4-6
Motor Scope Selection Guide	7-18
C-Frame Motors	19-20
Unit Bearing Motors	21
3.3" Diameter Motors	22-30
<i>General Purpose Motors</i>	22-25
<i>Refrigeration Fan Motors</i>	26
<i>Evaporator Coil Motors</i>	26
<i>Self Cooled Motors</i>	27
<i>Window A/C Motors</i>	28
<i>Flue Exhaust and Draft Booster Blower Motors</i>	29-30
4.4" Diameter Motors	31-33
<i>General Purpose Motors</i>	31
<i>Fan Coil Air-Conditioning and Heating Unit Motors</i>	32
<i>Refrigeration Fan Motors</i>	33
5.0" Diameter Motors	34-37
<i>Condenser Fan & Heat Pump - Cap-Can Construction</i>	34
<i>Fan Coil Air-Conditioning and Heating Unit Motors</i>	35
<i>Direct Drive Blower Motors</i>	36
<i>Ventilator and Unit Heater Motors</i>	37
5.6" Diameter Motors	38-49
<i>Condenser Fan Motors</i>	38-40, 42-43, 46
<i>Multi-Purpose Motors</i>	41
<i>Direct Drive Blower Motors</i>	44-46
<i>Unit Heater Motors</i>	45
<i>Window A/C Motors</i>	46-47
<i>50Hz Export Motors</i>	48
<i>Pedestal Fan Motors</i>	49
NEMA 48 and 56 Frame Motors	50
Blowers	51-59
Centrifugal Blowers	60-65
Transflo® Blowers	66
OEM Direct - Water Heater Draft Inducers	67
OEM Direct Replacement Models	68-95
Contactors	96-98
Fan Blades	99-102
Blower Wheels	103-104
Accessories	105-111
PROLINE™ Capacitors	112-114
Notes Glossary	115

FASCO reserves the right to change or modify product revision levels without notice.

PSC Motors use 5M 370V capacitors unless otherwise indicated.

Alphanumeric Index



MODEL	WT. (lbs.)	PAGE	MODEL	WT. (lbs.)	PAGE	MODEL	WT. (lbs.)	PAGE	MODEL	WT. (lbs.)	PAGE	MODEL	WT. (lbs.)	PAGE
1-6000	0.5	103	4CL1827	2.3	100	A086	5	56, 88, 93	A216	5.25	54, 83	C3D205	0.50	113
1-6002	0.7	103	4CL1833	2.3	100	A087	7.3	51, 68, 88	A217	5.25	54, 83	C3D207.5	0.50	113
1-6005	1.5	103	4CL2026	2.5	100	A088	5	51, 72	A218	4.5	55, 83	C3D255	0.50	113
1-6006	1.7	103	4CL2033	2.5	100	A090	8	55, 65, 88	A219	4.5	55, 83	C3D257.5	0.50	113
1-6007	2	103	4CL2033-4	2.5	101	A100	4.5	51, 73	A220	6.7	59, 95	C3D305	0.50	113
1-6008	2	103	4CL2227	3.7	100	A110	4.6	51, 74	A221	6.9	59, 95	C3D307.5	0.50	113
1-6009	2	103	4CL2235	3.7	100	A111	5.65	51, 74	A222	5.4	59, 95	C3D355	0.50	113
1-6010	2	103	4CL2423	4	100	A118	7.4	58, 65, 94	A223	5.6	59, 95	C3D357.5	0.50	113
1-6024	0.7	103	4CL2427	4	100	A120	5.75	51, 68	A224	6.1	59, 95	C3D405	0.50	113
1-6025	0.7	103	4CR1423	1.2	100	A121	4.25	55, 86	A225	4.75	59, 95	C3D407.5	0.50	113
1-6026	0.7	103	4CR1433	1.2	100	A122	6.4	55, 86	A226	4.5	59, 95	C3D455	0.50	113
1-6027	2	103	4CR1433-4	1.2	101	A123	5.7	55, 86	A227	6.1	59, 95	C3D457.5	0.50	113
1-6028	2	103	4CR1623	1.4	100	A124	6.4	55, 86	A228	7	59, 95	C3D505	0.50	113
1-6038	0.4	103	4CR1633	1.4	100	A125	6	62	A229	6.1	59, 95	C3D507.5	0.50	113
1-6039	0.4	103	4CR1633-4	1.4	101	A126	5.7	55, 86	A230	6.1	59, 95	C3D1010	0.50	113
1-6040	0.4	103	4CR1827	2.3	100	A128	4	51, 72	A231	4.5	59, 95	C3D1510	0.50	113
1-6041	0.4	103	4CR1833	2.3	100	A129	6	51, 68	A234	3.5	59, 95	C3D2010	0.50	113
1-6042	0.4	103	4CR1833-4	2.3	101	A130	5	57, 90	A240	5.3	56, 87	C3D2510	0.50	113
1-6043	0.4	103	4CR2026	2.5	100	A130	5	57, 90	A241	5.8	56, 87	C3D3010	0.50	113
1-6044	0.4	103	4CR2029	2.5	100	A131	4.2	55, 86	A242	6.3	56, 87	C3D3510	0.50	113
1-6045	0.4	103	4CR2033	2.5	100	A132	5.5	55, 86	A243	6	56, 87	C3D4010	0.50	113
1-6046	0.5	103	4CR2033-4	2.5	101	A133	5	53, 77	A244	8.7	56, 87	C3D4510	0.50	113
1-6047	0.5	103	4CR2223	3.7	100	A134	5	53, 79	A245	8.5	56, 87	C3D5010	0.50	113
1-6048	0.5	103	4CR2227	3.7	100	A135	3.2	54, 82	A246	6.1	56, 87	C3DR155	0.50	113
1-6051	0.4	103	4CR2233-4	3.7	101	A136	5	56, 88	A247	5.8	56, 87	C3DR157.5	0.50	113
1-6052	0.5	103	4CR2235	3.7	100	A137	5	58, 94	A251	4.3	56, 89	C3DR205	0.50	113
1-6053	0.7	103	4CR2418	4	100	A138	4.2	54, 82	A260	5.82	57, 91	C3DR207.5	0.50	113
1-6054	0.7	103	4CR2423	4	100	A139	3.5	56, 88	A261	5.75	57, 91	C3DR255	0.50	113
1-6057	0.7	103	4CR2427	4	100	A140	4.2	52, 76	A262	5.75	57, 91	C3DR257.5	0.50	113
1-6058	1.1	103	4CR2433	4	100	A141	5	53, 79	A263	5.7	57, 91	C3DR305	0.50	113
1-6060	1.1	103	4CR2433-4	3.7	101	A142	5	56, 86, 88	A264	5.25	57, 91	C3DR307.5	0.50	113
1-6063	1.1	103	4CR2627	4	100	A143	5	56, 90	A265	5.3	57, 91	C3DR355	0.50	113
1-6064	1.1	103	4CR2633	4.1	100	A143	4.5	56, 90	A266	5.3	57, 91	C3DR357.5	0.50	113
1-6066	1.5	103	50745-D500	2	60	A144	5.2	58	A267	5.3	57, 91	C3DR405	0.50	113
1-6070	1.5	103	50746-D500	5	62	A145	5	53, 79	A268	5.3	57, 91	C3DR407.5	0.50	113
1-6071	2	103	50747-D230	4	60	A146	3	56, 90	A269	6.5	57, 91	C3DR455	0.50	113
1-6074	1.7	103	50747-D401	4	60	A146	3	56, 90	A270	6	57, 91	C3DR457.5	0.50	113
1-6076	2	103	50747-D500	3.5	60	A148	4.8	53, 77, 79	A271	6	57, 91	C3DR505	0.50	113
1-6077	1.7	103	50747-D600	3	60	A150	5	57, 90	A272	6	58, 91	C3DR507.5	0.50	113
1-6078	2	103	50748-D500	4.5	60	A150	5	57, 90	A273	6	58, 91	C3DR555	0.50	113
1-6079	2	103	50748-D700	4	60	A151	4	53, 77, 79	A274	8.6	58, 91	C3DR557.5	0.50	113
1-6080	2	103	50752-D230	6	63	A154	4	58, 94	A276	3.625	58, 91	C3DR605	0.50	113
1-6113	0.4	103	50752-D500	6	63	A155	4	51, 69	A278	5	58, 91	C3DR607.5	0.50	113
1-6114	0.4	103	50755-D230	7	63	A156	4	51, 73	A279	5.2	58, 91	C3DR705	0.50	113
1-6123	2	103	50755-D500	6	63	A157	4	52, 76	A280	3.625	52, 68	C3DR707.5	0.50	113
1-6133	0.5	103	50756-D230	11.5	64	A158	4	51, 68	A281	4.75	52, 76	C3DR805	0.50	113
1-6141	0.5	103	50756-D500	10	64	A159	6	51, 63, 74	A282	5.3	52, 76	C3DR807.5	0.50	113
1-6143	0.7	103	50757-D500	2.5	62	A160	4	51, 68	A283	5.32	52, 68	C3DR1510	0.50	113
1-6160	0.5	103	50769-D230	12	64	A161	7	51, 63, 74	A284	5	52, 76	C3DR2010	0.50	113
1-6161	0.5	103	50769-D500	13	64	A162	4	52, 76	A285	5	52, 76	C3DR2510	0.50	113
2-6011	0.6	104	5FL1020-1	0.31	102	A163	4	54, 82	A286	5	52, 68	C3DR3010	0.50	113
2-6012	1.2	104	5FL1020-2	0.31	102	A164	3	54, 82	A287	4.75	52, 68	C3DR3510	0.50	113
2-6013	1.2	104	5FL1031-2	0.31	102	A165	4	59, 94	A288	5.5	52, 76	C3DR4010	0.50	113
2-6014	1.2	104	5FL727-1	0.15	102	A166	6	62	A289	5.25	52, 68	C3DR4510	0.50	113
2-6015	1.6	104	5FL727-2	0.15	102	A167	3	60	A290	4.75	52, 76	C3DR5010	0.50	113
2-6016	2	104	5FL824-1	0.18	102	A168	3.4	59, 94	A301	4.5	53, 80	C3DR5510	0.50	113
2-6017	2	104	5FL824-2	0.18	102	A169	7	53, 79	A302	5	53, 80	C3DR6010	0.50	113
2-6018	2	104	5FL832-1	0.18	102	A170	7	53, 79	A304	5	53, 80	C3DR7010	0.50	113
2-6019	3	104	5FL832-2	0.18	102	A171	6.6	53, 79	A306	6	53, 80	C3DR8010	0.50	113
2-6020	3	104	5FL926-1	0.25	102	A172	6.6	53, 79	A307	3.4	53, 80	C3RS5	0.30	112
2-6021	3.5	104	5FL926-2	0.25	102	A173	9	53, 79	A320	4.25	55, 83	C3RS7.5	0.30	112
2-6022	3.5	104	5FR1020-1	0.31	102	A174	4.5	53, 79	A322	4	55, 83	C3RS10	0.30	112
2-6029	6	104	5FR1020-2	0.31	102	A175	5.6	53, 79	A324	6.5	55, 83	C3RS15	0.30	112
2-6030	1.2	104	5FR1023	0.1	102	A176	6.95	53, 80	A325	7.5	55, 83	C3RS17.5	0.30	112
2-6031	1.2	104	5FR1028	0.3	102	A177	7.25	53, 80	A329	5.5	55, 83	C3RS20	0.30	112
2-6032	1.2	104	5FR1031-2	0.31	102	A178	6.75	53, 80	A330	6.1	55, 83	C3RS25	0.30	112
2-6033	1.2	104	5FR721	0.3	102	A179	5.85	53, 80	A331	6.5	55, 83	C3RS30	0.30	112
2-6034	1.6	104	5FR727-1	0.15	102	A180	7	52, 68	A360	5.125	58, 92	C3RS35	0.30	112
2-6035	2	104	5FR727-2	0.15	102	A181	6.9	52, 76	A361	5	58, 92	C3RS40	0.30	112
2-6036	2	104	5FR823	0.3	102	A182	5.5	52, 76	A362	5	58, 92	C3RS45	0.30	112
2-6037	3.5	104	5FR824-1	0.18	102	A184	6.1	52, 76	A367	5.3	58, 92	C3RS50	0.30	112
2-6082	1.2	104	5FR824-2	0.18	102	A185	4.75	52, 68	A368	4.7	58, 92	C3RS55	0.30	112
2-6083	1.6	104	5FR832-1	0.18	102	A187	6.9	52, 76	A369	5.2	58, 92	C3RS60	0.30	112
2-6084	1.6	104	5FR832-2	0.18	102	A188	4.5	52, 76	A370	5	58, 92	C3RS70	0.30	112
2-6085	1.6	104	5FR925	0.3	102	A189	5.35	52, 76	A373	6.5	58, 92	C3RS80	0.30	112
2-6086	2	104	5FR926-1	0.25	102	A191	6.4	57, 90	A455	14	64	C3S2	0.30	112
2-6087	2	104	5FR926-2	0.25	102	A192	5.5	57, 90	A1000	24	64	C3S3	0.30	112
2-6089	3	104	A051	6.25	53, 79	A193	6	57, 90	A1200	28	65	C3S4	0.30	112
2-6090	3	104	A063	5	58, 60, 94	A194	6.1	57, 90	B30	3	60	C3S5	0.30	112
2-6092	3.5	104	A064	5	53, 65, 77	A195	6.2	57, 90	B75	3	61	C3S6	0.30	112
2-6093	3.5	104	A065	5.8	52, 76	A196	5.6	57, 90	B160	6	63	C3S7.5	0.30	112
2-6139	1.6	104	A066	7	56, 87	A197	5.8	57, 90	B22505	3	66	C3S10	0.30	112
2CL1827	1.5	99	A067	6.45	53, 79	A198	5.8	57, 91	B22507	4	66	C3S12.5	0.30	112
2CL2025	1.5	99	A068	3.75	54, 82	A199	5.8	57, 91	B22508	3.6	66	C3S15	0.30	112
2CL2227	1.5	99	A069	4.8	56, 61, 90	A200	7	54, 82	B22510	4	66	C3S17.5	0.30	112
3CR1827	2	99	A069	4.8	56, 61, 90	A201	4.1	54, 82	B22513	5	66	C3S20	0.30	112
3CR1833	2	99	A071	3	61	A202	4.6	54, 82	B22515	3.2	66	C3S25	0.30	112



Alphanumeric Index

MODEL	WT. (lbs.)	PAGE	MODEL	WT. (lbs.)	PAGE	MODEL	WT. (lbs.)	PAGE	MODEL	WT. (lbs.)	PAGE	MODEL	WT. (lbs.)	PAGE
C4D257.5	0.50	113	D118	5	11, 31	D261	9	12, 37, 107	D541	2	9, 24, 86	D774	11.5	15, 46
C4D305	0.50	113	D119	6	11, 31	D262	9.8	12, 36, 93	D550	2	7, 21	D775	10	14, 46
C4D307.5	0.50	113	D120	2	9, 23	D264	7.8	12, 36, 75, 107	D551	2	7, 21	D776	11	14, 46
C4D355	0.50	113	D121	2	9, 23	D277	11	12, 35, 107	D552	2	7, 21	D777	17	16, 46
C4D357.5	0.50	113	D122	2.5	9, 24	D289	7.5	13, 35	D553	2	7, 21	D778	19	17, 46
C4D405	0.50	113	D123	2.5	9, 24	D290	9	12, 35, 107	D554	2	7, 21	D780	15	15, 46, 107
C4D407.5	0.50	113	D124	3	9, 24	D291	13	12, 35	D555	2	7, 21	D781	15	15, 46
C4D455	0.50	113	D125	3	9, 24	D292	10	12, 35	D556	2	7, 21	D782	13	15, 46, 107
C4D457.5	0.50	113	D126	2.5	9, 23	D293	7	13, 35	D557	2	7, 21	D783	12	15, 46, 72, 107
C4D505	0.50	113	D127	3	9, 23	D294	10.5	12, 35	D558	3	7, 21	D784	16	16, 46, 107
C4D507.5	0.50	113	D128	3	9, 23	D310	4.50	11, 31	D559	3	7, 21	D785	17	16, 46, 107
C4D1010	0.50	113	D129	2.5	8, 23	D312	7	11, 31, 107	D560	3	7, 21	D786	18.5	17, 46, 107
C4D1510	0.50	113	D130	3	9, 27, 89	D314	8.5	13, 36, 107	D561	3	7, 21	D787	13.5	16, 46, 107
C4D2010	0.50	113	D131	3	9, 27	D316	8	13, 36, 107	D562	3	7, 21	D788	16.5	17, 46, 107
C4D2510	0.50	113	D132	3.5	10, 23	D318	9.5	13, 36	D563	3	7, 21	D789	19	17, 46, 107
C4D3010	0.50	113	D133	3.5	10, 23	D323	4.5	8, 28, 88	D564	3	7, 21	D790	20	17, 39
C4D3510	0.50	113	D134	4.5	10, 27	D325	5.5	11, 28, 88	D565	3	7, 21	D791	17	16, 39
C4D4010	0.50	113	D135	4.5	10, 27	D326	5.5	8, 28	D566	3	7, 21	D792	13	15, 39
C4D4510	0.50	113	D136	4	9, 23	D329	7.50	11, 32, 107	D567	5	7, 21	D793	12	14, 39
C4D5010	0.50	113	D137	3.5	9, 24, 88	D330	4	9, 27	D568	5	7, 21	D794	12	14, 39
C4DR155	0.5	114	D138	5	10, 27	D332	4	10, 23	D569	5	7, 21	D795	17	16, 39, 69
C4DR157.5	0.5	114	D140	5.5	13, 37	D333	5	11, 32, 107	D570	5	7, 21	D796	16	16, 39
C4DR205	0.5	114	D142	5	13, 37	D334	6	11, 27	D571	5	7, 21	D797	12.3	15, 39
C4DR207.5	0.5	114	D143	5	12, 37	D335	7	11, 32, 107	D572	5	7, 21	D798	12	14, 39
C4DR255	0.5	114	D144	7	13, 37	D336	8	11, 32, 107	D573	6	7, 21	D799	12	14, 39
C4DR257.5	0.5	114	D148	6.5	13, 37, 107	D337	9	11, 32, 107	D574	6	8, 21	D800	19.3	18, 78
C4DR305	0.5	114	D150	11.5	12, 36, 107	D338	10	11, 32, 107	D575	6	8, 21	D801	14	16, 78
C4DR307.5	0.5	114	D151	11.5	12, 36, 107	D339	9.50	11, 32, 107	D576	6	8, 21	D802	18	17, 42, 71
C4DR355	0.5	114	D152	11.7	12, 36, 107	D340	7	12, 37	D577	6	8, 21	D803	16	15, 69
C4DR357.5	0.5	114	D154	8.5	13, 36, 107	D342	5.6	13, 37, 86	D578	7	8, 21	D806	16	16, 87
C4DR405	0.5	114	D156	9	13, 36, 107	D347	7.2	12, 35, 107	D579	7	8, 21	D807	9.5	14, 78, 107
C4DR407.5	0.5	114	D158	11	13, 36, 107	D354	11	12, 35, 107	D580	7	8, 21	D812	13.5	15, 84, 107
C4DR455	0.5	114	D160	9	13, 36, 107	D356	9	13, 36, 107	D581	7	8, 21	D813	23	17, 84
C4DR457.5	0.5	114	D164	9	13, 36, 107	D364	3.3	10, 23	D582	2.4	21	D816	15	16, 84, 107
C4DR505	0.5	114	D164	9	13, 36, 107	D365	3.5	10, 23	D583	2.4	21	D817	18	17, 45
C4DR507.5	0.5	114	D166	9	13, 36, 107	D366	4	11, 28	D601	3	9, 24	D818	17.2	15, 84, 107
C4DR555	0.5	114	D167	2.5	9, 27	D367	5.5	11, 28	D602	3	9, 24	D819	20	17, 42
C4DR557.5	0.5	114	D169	2.5	9, 27	D374	7.00	11, 31	D603	3	9, 23	D820	14.5	15, 73
C4DR605	0.5	114	D170	4.50	11, 31	D377	4	11, 31, 81	D608	3	9, 22	D821	13	16, 42, 107
C4DR607.5	0.5	114	D174	6.50	11, 31, 107	D377	4.00	11, 31, 81	D609	3	9, 23	D823	18	17, 42, 107
C4DR705	0.5	114	D176	6.5	13, 36, 107	D382	6.6	12, 35, 107	D624	3	9, 24	D824	13	14, 49, 73, 86
C4DR707.5	0.5	114	D177	6.1	13, 36, 85	D389	8.4	13, 35, 107	D635	8.00	11, 32, 107	D825	21.5	18, 73, 107
C4DR805	0.5	114	D178	6.5	13, 36, 72, 107	D402	2.5	9, 22	D636	4	10, 23	D827	14	14, 68, 77
C4DR807.5	0.5	114	D180	6.5	13, 36	D403	2.5	9, 22	D655	7.5	13, 35, 107	D829	16	15, 77
C4DR1510	0.5	114	D181	3.5	9, 23	D404	5	8, 22, 80	D656	9	13, 36, 107	D832	12	14, 87
C4DR2010	0.5	114	D182	3	9, 24	D405	5.5	8, 22, 80	D658	9	13, 36, 107	D833	15	17, 41
C4DR2510	0.5	114	D184	4	10, 23	D408	3.5	8, 29, 72	D658	10.5	13, 36, 107	D834	15	14, 45
C4DR3010	0.5	114	D186	3.4	10, 24, 74	D410	5.5	8, 29	D674	7.00	11, 31	D837	14	16, 41
C4DR3510	0.5	114	D188	3.5	10, 23	D412	5.5	8, 29	D701	20	16, 44, 107	D838	17.2	17, 71, 107
C4DR4010	0.5	114	D189	4	10, 24	D415	4.5	9, 29	D701	20	16, 44, 107	D842	13	14, 71
C4DR4510	0.5	114	D190	2.5	9, 23	D417	25	7, 03	D703	20	16, 44, 107	D843	12	15, 71
C4DR5010	0.5	114	D192	4.5	10, 27	D418	4.5	9, 29	D711	20.5	18, 44, 107	D844	8.5	15, 71
C4DR5510	0.5	114	D200	1.5	8, 22	D429	2.5	8, 25	D712	22	18, 44	D847	8.8	14, 70
C4DR6010	0.5	114	D201	1.5	8, 22	D431	2.2	8, 25	D713	13	17, 39	D848	12	14, 71
C4DR7010	0.5	114	D202	2.5	9, 22	D435	8.00	11, 31, 107	D719	11	14, 38	D854	14	15, 75
C4DR8010	0.5	114	D203	3	9, 22	D437	3	8, 25	D720	9	14, 38	D855	13	15, 75
C4RS5	0.30	112	D205	3	9, 22	D441	2.5	9, 74	D721	15	14, 44, 107	D856	17	15, 75
C4RS7.5	0.30	112	D206	3	9, 22	D454	4	10, 30	D721	15	14, 44, 107	D857	10	13, 89
C4RS10	0.30	112	D207	3	9, 22	D455	4	10, 29, 70	D723	15	15, 44, 107	D859	13	15, 89
C4RS12.5	0.30	112	D208	3	10, 22	D456	5	11, 30, 70	D724	19	17, 44, 87	D860	20	16, 89, 107
C4RS15	0.30	112	D209	3	10, 22	D457	5	11, 30, 70	D725	15	14, 44, 107	D860	20	16, 89, 107
C4RS20	0.30	112	D210	3.5	10, 22	D458	4.5	11, 30, 70	D726	19	17, 44, 107	D862	18	16, 75
C4RS25	0.30	112	D211	4	10, 22	D459	5	11, 71, 88	D727	14	15, 44, 107	D863	20.7	17, 82
C4RS30	0.30	112	D213	3.7	10, 22	D461	4.5	8, 88	D728	20.5	17, 44, 107	D864	12	14, 71
C4RS35	0.30	112	D214	5	10, 22	D463	3	10, 71	D729	21	17, 44, 107	D868	17	15, 74
C4RS40	0.30	112	D215	4.75	10, 22	D469	4.7	11, 25	D730	19.5	17, 44, 107	D870	14	15, 93, 107
C4RS45	0.30	112	D216	3.5	10, 22	D470	4.2	10, 25	D730	19.5	17, 44, 107	D872	15.2	17, 80
C4RS50	0.30	112	D218	4.5	8, 22	D471	4.7	10, 25	D732	18	16, 45	D873	15	17, 94
C4RS55	0.30	112	D219	4.5	8, 22	D472	4.3	10, 25	D733	15	14, 45, 107	D880	14.15	15, 77
C4RS60	0.30	112	D220	4.7	10, 22	D473	4.4	10, 25	D734	13.8	15, 45	D882	10	14, 74
C4RS70	0.30	112	D221	8.8	35, 107	D474	10	12, 34, 107	D735	18.2	16, 38, 107	D884	11	14, 74
C4RS80	0.30	112	D222	3.5	10, 29	D475	5.3	11, 25, 89	D736	13.5	14, 45	D890	15	17, 78
C4S5	0.30	112	D224	12	13, 35, 107	D477	4.5	9, 25	D737	15	15, 38, 107	D894	11.2	14, 75
C4S7.5	0.30	112	D226	4.5	10, 27	D480	8.00	11, 33, 107	D739	15	14, 38, 107	D895	10	14, 92
C4S10	0.30	112	D227	5	10, 27	D481	8.00	11, 33, 107	D740	17	17, 38	D896	11	14, 75, 107
C4S12.5	0.30	112	D228	2.3	9, 22	D482	7.00	11, 33, 107	D742	11	15, 38	D897	12.5	14, 75, 107
C4S15	0.30	112	D229	3	8, 22	D483	7.00	11, 33, 107	D743	9	14, 38	D900	23.4	16, 49
C4S17.5	0.30	112	D230	3	8, 22	D484	6.00	11, 33, 107	D744	16	15, 38	D901	17.5	15, 49
C4S20	0.30	112	D234	5	10, 27	D485	6.00	11, 33, 107	D745	16.5	17, 38, 107	D902	15	16, 44, 107
C4S25	0.30	112	D235	6	11, 27	D486	8.5	12, 34, 107	D748	12	16, 38, 107	D903	16.5	16, 39
C4S30	0.30	112	D236	8.00	11, 32, 107	D487	8.5	12, 34, 107	D749	11	15, 38	D904	13	15, 39
C4S35	0.30	112	D238	6	11, 27	D488	8	12, 34, 107	D750	12	13, 47	D905	10.5	14, 39
C4S40	0.30	112	D240	9.5	13, 37	D489	9	12, 34, 107	D751	12	13, 47	D906	12	14, 39
C4S45	0.30	112	D242	9	13, 37	D490	9	13, 34, 107	D752	12	14, 47	D907	17	17, 40
C4S50	0.30	112	D245	13	12, 35, 107	D491	8.5	13, 34, 107	D754					

Alphanumeric Index



MODEL	WT. (lbs.)	PAGE	MODEL	WT. (lbs.)	PAGE	MODEL	WT. (lbs.)	PAGE	MODEL	WT. (lbs.)	PAGE	MODEL	WT. (lbs.)	PAGE
D922	13.5	15, 39	D1117	3.13	9, 84	D2800	16.5	17, 87	H350B	4	96, 97	KIT325	0.2	110
D923	13	15, 44, 107	D1118	4	9, 24, 72	D2810	10.6	14, 77	H350C	4	96, 97	KIT350	0.2	110
D925	15.5	16, 39	D1119	4	9, 23, 70	D2814	16.5	17, 84, 107	H360A	4	96, 97	KIT378	0.1	110
D927	9.4	14, 44, 107	D1120	5	10, 26, 81	D2816	21.7	18, 84, 107	H360B	4	96, 97	KIT380	0.3	109
D928	9.3	14, 44, 107	D1121	5	10, 26, 81	D2817	15.9	16, 84, 107	H360C	4	96, 97	KIT410	0.1	108
D929	17.9	18, 38, 107	D1122	4	8, 77	D2818	19.6	17, 84, 107	H375AC		96, 97	KIT414	0.1	109
D930	18.4	17, 38, 107	D1123	4.5	8, 77	D2826	17	16, 41	H375BC		96, 97	KIT465	0.3	111
D931	19	18, 40	D1124	4	10, 26, 69	D2827	18	16, 41	H375CC		96, 97	KIT832	0.1	111
D932	17.5	17, 40	D1125	3.6	8, 26, 69	D2832	22	17, 41, 107	H390AC		96, 97	KIT1032	0.1	111
D933	20	18, 40	D1126	4	10, 26, 69	D2833	22	17, 41, 107	H390BC		96, 97	KIT6001	0.1	111
D934	13	15, 39	D1129	4	8, 25	D2834	11.5	16, 87	H390CC		96, 97	K-NUT		20
D935	16.5	17, 38, 107	D1130	2.5	8, 22	D2835	16	17, 41, 41	H3R30A	2	96, 97	K-NUT6002		20
D936	14	16, 39	D1134	4	9, 23, 93	D2840	10	14, 87	H3R30B	2	96, 97	LCK-CID-001	0.53	114
D937	11.7	107	D1138	4.12	9, 27, 70	D2842	11	14, 87	H3R30C	2	96, 97	LCK-DBA-001	0.06	114
D938	20	17, 39	D1139	3.25	9, 24, 70	D2844	10	13, 87	H430A	1.5	96, 97	LCKP-001	4.6	114
D939	10.9	15, 38, 107	D1140	5.7	8, 85	D2850	23.5	18, 75, 92	H430B	1.5	96, 97	LCK-SBA-001	0.15	114
D940	18.5	18, 38, 107	D1141	6	85	D2851	23.5	18, 75, 93	H430C	1.5	96, 97	MNT1518	0.1	110
D944	13	16, 38	D1142	4.8	10, 26, 85	D2862	21.5	17, 82	H440A	1.5	96, 97	NO33L	0.3	105
D951	19.5	17, 38, 107	D1144	4.7	8, 26, 85	D2871	20.2	18, 94	H440B	1.5	96, 97	NO50L	0.3	105
D960	15	16, 43	D1151	3.4	9, 73	D3752	13	14, 48	H440C	1.5	96, 97	NO55L	0.5	105
D961	20	17, 43	D1152	3.2	10, 26, 82	D3755	16	14, 48	H6S	0.1	97	NO55S	0.5	105
D966	14	16, 42, 107	D1154	3.7	10, 26, 82	D3758	20	15, 48	H7S	0.1	97	RAIN6000	0.1	111
D967	20	17, 42, 107	D1155	3	8, 89	D3760	22	16, 48	H9S		97	RAIN6017	0.1	111
D968	20	18, 42, 107	D1158	4.5	10, 81	D3771	15	15, 48	INLET4000	0.3	106	RAIN6018	0.1	111
D970	17.7	17, 45, 107	D1159	2.5	8, 73	D3772	17	16, 48	INLET4004	0.3	106	RAIN6018	0.1	111
D971	15	16, 45, 107	D1160	2.5	8, 73	D3774	14	14, 48	K100	1.5	7, 19, 73	RUBBERBOOT	0.1	111
D972	13	15, 45, 107	D1161	4	10, 24, 73	D3775	11	14, 48	K101	2.3	7, 19, 73	S156	9	37, 85, 107
D973	10.8	14, 45, 107	D1162	3.4	8, 24, 73	D5458	13	14, 42	K102	1.3	7, 19, 73	S719	9.3	38
D974	16, 45, 107	D1164	3.8	10, 24, 26, 89	D5459	11	13, 42	K109	1.5	7, 19	S2846	19	42, 71, 107	
D974	18	16, 45, 107	D1165	4	10, 89	D5488	10.5	14, 39	K110	1.5	7, 19, 69	S2848	23	42, 71, 107
D975	11.2	14, 45, 107	D1167	4	9, 29, 79, 89	D5489	14	15, 39	K111	1	7, 19	SHLD6301	0.2	108
D976	20	16, 45	D1169	5	11, 30, 89	D6002	12	18, 50	K112	2.1	7, 20	SHLD6302	0.2	108
D979	11	14, 45	D1170	6	11, 31, 81	D6004	15	18, 50	K113	1.5	7, 20	SHLD6303	0.2	108
D980	13	15, 42	D1171	6	10, 30, 94	D6006	18	18, 50	K114	1.5	7, 19, 78	SHLD6304	0.2	108
D982	14	16, 42	D1173	4.13	9, 27, 81	D6066	26	18, 50	K115	1.5	7, 19	SHLD6311	0.2	108
D997	23	16, 49	D1174	5	10, 30, 70	D6068	31	18, 50	K120	1.5	7, 19	SHLD6312	0.2	108
D998	21.2	17, 49	D1176	4.5	8, 28, 72	D6070	30	18, 50	K130	2.2	7, 19	SLINGR6002	0.1	111
D999	23	16, 49	D1178	5	8, 70	D6073	39	18, 50	K141	2	7, 20	STB1	0.3	105
D1001	8.5	13, 72	D1179	2.5	9, 30, 69	D6082	19	18, 50	K142	2	7, 20	STB2	0.3	105
D1005	10.1	12, 35, 92	D1180	4.1	10, 30, 69	D6084	22	18, 50	K143	2	7, 20	STB3	0.3	105
D1006	9.2	11, 32, 89	D1182	5	8, 71	D6086	28	18, 50	K144	2	7, 20	STB4	0.3	105
D1006	9.20	11, 32, 89	D1184	5	8, 29	D6088	33	18, 50	K145	1.5	7, 19	STB5	0.3	105
D1008	5.3	11, 84	D1186	4.8	8, 29	D6090	39	18, 50	K146		7, 20	STB6	0.3	105
D1010	8.5	13, 74	D1188	4.5	10, 29	D6093	47	18, 50	K147		7, 20	STB7	0.3	105
D1011	7.7	13, 74	D1189	4	10, 81	D6608	34	18, 50	K161	1.5	7, 20, 85	STB8	0.3	105
D1012	6.08	11, 74	D1190	4.3	9, 30, 93	D6610	43	18, 50	K610	2	7, 20, 69	W1	12	67
D1016	8.9	12, 74, 107	D1191	4	9, 29, 94	D6622	19	18, 50	K611	1.7	7, 19, 69	W2	10	67
D1022	9.4	12, 72	D1192	4	9, 29	D6624	22	18, 50	K612	1.5	7, 20, 69	W3	7	67
D1025	7	12, 35, 107	D1193	3	10, 29	D6626	26	18, 50	K614	1.2	7, 19	W4	11	67
D1028	5.3	13, 37, 68	D1194	4	10, 29	D6628	32	18, 50	K628	2.5	7, 19, 88	W5	11	67
D1032	11	12, 93	D1196	3	9, 29	D6630	35	18, 50	K629	4	7, 19, 73	W6	14	67
D1033	10.5	12, 73, 89, 107	D1198	15	9, 29, 83	D6631	37	18, 50	K670	1.6	7, 19	W7	7	67
D1036	4.6	13, 37, 86	D1243	4	8, 26, 81	D6633	48	18, 50	K672	1.5	7, 19	W8	5	67
D1038	6.4	13, 37	D1245	4	8, 26, 81	D7745	16	17, 38, 107	K673	1.5	7, 19	W9	6	67
D1039	6.06	11, 31, 78	D1246	6	11, 81, 107	D7748	14	16, 38, 107	K683	1.5	7, 19	W10	11	67
D1040	11.25	12, 78	D1700	18	16, 40	D7749	11	15, 38, 107	K-FAN4031		20			
D1041	8.25	12, 78	D1701	16	15, 39	D7907	17	17, 40	K-FAN4032		20			
D1042	10.6	12, 94, 107	D1702	13	14, 39	D7908	15	16, 39	K-FAN6009		20			
D1043	12.25	12, 78	D1703	15	14, 45	D7909	12	15, 39	K-FAN6010		20			
D1044	11.5	12, 78	D1704	15	15, 45	FK100	0.1	111	K-FAN6011		20			
D1045	7.5	12, 78	D1705	15	16, 45	FK101	0.1	111	K-FAN6012		20			
D1046	8	13, 36, 82, 107	D1706	15	14, 45	FM50	0.5	105	K-FAN6013		20			
D1047	8.5	12, 78	D1707	15	15, 45	FM55	0.4	105	K-FAN6046		20			
D1048	9.0	12, 78	D1708	15	16, 45	FM554		105	KIT34	0.1	105			
D1049	8.75	12, 78	D1709	21.25	18, 38, 107	G2243	7.2	12, 34	KIT49	0.3	105			
D1050	7.2	12, 12, 35, 75, 92	D1710	21.6	18, 42, 107	G2244	10.10	12, 34	KIT50	0.3	105			
D1051	3.4	12, 92, 107	D1730	15	14, 44	G2245	10.05	12, 34	KIT100	0.1	106			
D1053	6.45	12, 78	D1731	15	15, 44	G2246	9.5	12, 34	KIT102	0.1	106			
D1054	8	13, 37, 78	D1732	18	16, 44	G2247	9.5	12, 34	KIT142	0.2	106			
D1055	10.5	12, 78	D1733	11	14, 44	G2248	7.95	12, 34	KIT144	0.2	106			
D1056	8.1	12, 68	D1734	12	15, 44	G2249	7.4	12, 34	KIT150	0.1	105			
D1058	8	12, 68, 92	D1735	15	16, 44	GASKET0167	0.1	111	KIT170	0.1	111			
D1059	9.5	12, 78	D1745	16.5	17, 39, 107	GROM6000	0.1	110	KIT180	0.1	110			
D1061	8.5	11, 31, 77, 107	D1748	12.13	16, 39, 107	GROM6008	0.1	110	KIT183	0.1	110			
D1061	8.50	11, 31, 77, 107	D1749	10.8	15, 39, 107	H5	0.1	105	KIT184	0.1	110			
D1062	10.12	12, 68	D1853	16	15, 75, 107	H6	0.1	105	KIT186	0.1	110			
D1065	7.5	12, 68, 107	D1910	19.2	17, 42, 107	H8	0.1	105	KIT187	0.1	110			
D1066	6	13, 13, 37, 70	D1911	17	17, 42, 107	H10	0.3	105	KIT199	0.4	109			
D1069	6	13, 72	D1914	20.2	17, 43	H33	0.5	109	KIT200	0.2	109			
D1071	8.5	12, 77	D2700	15.5	16, 44, 107	H130A	0.5	98	KIT205	0.3	109			
D1080	6	13, 72	D2701	16	16, 44, 107	H130B	0.5	98	KIT207	0.3	109			
D1081	6	12, 72	D2702	19	17, 44, 107	H130C	0.5	98	KIT208	0.1	110			
D1082	5	13, 85	D2703	18	17, 44, 107	H140A	0.5	98	KIT214	0.1	109			
D1086	8	12, 75, 107	D2704	20	18, 44, 107	H140B	0.5	98	KIT216	0.1	108			
D1087	7	13, 69	D2705	21.5	18, 44, 107	H140C	0.5	98	KIT218	0.1	109			
D1089	9	12, 92, 107	D2710	15.4	18, 43	H230A	0.5	98	KIT220	0.1	111			
D1090	8	12, 92	D2711	17.1	18, 43	H230B	0.5	98	KIT221	0.1	111			
D1091	12.4	12, 84	D2712	21	18, 43	H230C	0.5	98	KIT225	0.2	108			
D1100	3.2	9, 84	D2713	20	18, 43	H240A	0.5	98						

C-FRAME - K-LINE - SHADED POLE								
MODEL	HP	VOLTS	RPM	SPD.	AMPS	ROT.	BRNG.	SHAFT DIM.
K102	1/500	120	1100	1	0.57	CW	SLV	.1811 X 1.50
K114	1/500	120	1100	1	0.74	CW	SLV	.1811 X 1.75
K120	1/260	120	3000	2	.50 - .29	CW	SLV	.2178 X 1.55
K145	1/250	115	3000	1	.53	CW	SLV	.1814 X 1.00
K628	1/200	208/230	3000	1	0.25	CW	SLV	.2500 x 1.60
K101	1/150	240	1260	1	0.52	CCW	SLV	.2178 X 1.34
K130	1/150	115	3000	1	0.47	CW	SLV	.1811 X 1.00
K614	1/150	120	3000	1	0.59	CW	SLV	.2178 X 1.65
K670	1/150	120	3000	1	0.61	CCW	SLV	.1875 X 1.30
K672	1/150	240	3000	1	0.29	CCW	SLV	.1875 X 1.30
K673	1/150	120	3000	2	.51 - .27	CW	SLV	.1875 X 1.30
K111	1/120	120	3000	1	0.82	CCW	SLV	.2178 X 1.97
K100	1/100	120	2750	1	0.73	CW	SLV	.1811 X 1.05
K115	1/100	115	3000	1	0.57	CCW	SLV	.2178 X 1.85
K611	1/100	120	3000	1	0.63	CCW	SLV	.2500 X 2.45
K683	1/100	240	3000	1	0.30	CW	SLV	.1875 X 1.30
K629	1/85	120	2950	1	0.55	CW	SLV	.2500 x 1.13
K109	1/75	115	3000	1	0.77	CCW	SLV	.2178 X 2.37
K110	1/75	115	3000	1	0.77	CCW	SLV	.2178 X 2.44
K113	1/70	120	3000	1	0.90	CCW	SLV	.2178 X 1.19
K141	1/70	120	3000	1	0.65	CW	SLV	1.0 x .1814 x 0.75
K142	1/70	120	3000	1	0.63	CW	SLV	.1814 X 1.00
K143	1/70	220-240	3000	1	0.32	CW	SLV	.1814 X 1.00
K612	1/65	120	3000	1	0.73	CW	SLV	.2500 X 2.70
K610	1/60	120	3000	2	.75 - .63	CCW	SLV	.2178 X 1.33
K112	1/50	120	3000	2	.86 - .44	CW	SLV	.2178 X 1.44
K161	1/50	120	3000	1	0.90	CCW	SLV	.2178 X 1.21
K144	1/40	120	3000	1	1.00	CCW	SLV	.2178 x 1.50
K147	1/30	220-240	3000	1	0.69	CW	SLV	.2499 X 1.00
K146	1/20	120	3000	1	2.1	CW	SLV	.2499 X 1.00

UNIT BEARING MOTORS									
MODEL	WATT RATING	VOLTS	RPM	SPD.	AMPS	ENCLOSURE	ROT.	BRNG.	THREADED SHAFT
D550	2	115	1550	1	0.24	Totally Encl.	CWLE	SLV	1/4 - 20
D551	2	115	1550	1	0.24	Totally Encl.	CCWLE	SLV	1/4 - 20
D552	2	230	1550	1	0.12	Totally Encl.	CWLE	SLV	1/4 - 20
D553	2	230	1550	1	0.12	Totally Encl.	CCWLE	SLV	1/4 - 20
D554	4	115	1550	1	0.34	Totally Encl.	CWLE	SLV	1/4 - 20
D555	4	115	1550	1	0.34	Totally Encl.	CCWLE	SLV	1/4 - 20
D556	4	230	1550	1	0.16	Totally Encl.	CWLE	SLV	1/4 - 20
D557	4	230	1550	1	0.16	Totally Encl.	CCWLE	SLV	1/4 - 20
D558	6	115	1550	1	0.42	Totally Encl.	CWLE	SLV	1/4 - 20
D559	6	115	1550	1	0.42	Totally Encl.	CCWLE	SLV	1/4 - 20
D560	6	230	1550	1	0.21	Totally Encl.	CWLE	SLV	1/4 - 20
D561	6	230	1550	1	0.21	Totally Encl.	CCWLE	SLV	1/4 - 20
D562	9	115	1550	1	0.55	Totally Encl.	CWLE	SLV	1/4 - 20
D563	9	115	1550	1	0.55	Totally Encl.	CCWLE	SLV	1/4 - 20
D564	9	230	1550	1	0.33	Totally Encl.	CWLE	SLV	1/4 - 20
D565	9	230	1550	1	0.33	Totally Encl.	CCWLE	SLV	1/4 - 20
D566	16	115	1550	1	1.1	Totally Encl.	CWLE	SLV	1/4 - 20
D567	16	115	1550	1	1.1	Totally Encl.	CCWLE	SLV	1/4 - 20
D568	16	230	1550	1	0.6	Totally Encl.	CWLE	SLV	1/4 - 20
D569	16	230	1550	1	0.6	Totally Encl.	CCWLE	SLV	1/4 - 20
D570	25	115	1550	1	1.2	Totally Encl.	CWLE	SLV	1/4 - 20
D571	25	115	1550	1	1.2	Totally Encl.	CCWLE	SLV	1/4 - 20
D572	25	230	1550	1	0.66	Totally Encl.	CWLE	SLV	1/4 - 20
D573	25	230	1550	1	0.66	Totally Encl.	CCWLE	SLV	1/4 - 20

UNIT BEARING MOTORS									
MODEL	WATT RATING	VOLTS	RPM	SPD.	AMPS	ENCLOSURE	ROT.	BRNG.	THREADED SHAFT
D574	35	115	1550	1	1.5	Totally Encl.	CWLE	SLV	1/4 - 20
D575	35	115	1550	1	1.5	Totally Encl.	CCWLE	SLV	1/4 - 20
D576	35	230	1550	1	0.7	Totally Encl.	CWLE	SLV	1/4 - 20
D577	35	230	1550	1	0.7	Totally Encl.	CCWLE	SLV	1/4 - 20
D578	50	115	1550	1	1.8	Open Vent.	CWLE	SLV	3/8 x 1-1/2
D579	50	115	1550	1	1.8	Open Vent.	CCWLE	SLV	3/8 x 1-1/2
D580	50	230	1550	1	0.9	Open Vent.	CWLE	SLV	3/8 x 1-1/2
D581	50	230	1550	1	0.9	Open Vent.	CCWLE	SLV	3/8 x 1-1/2

PSC - 3.3 DIAMETER										
MODEL	DIA.	HP	VOLTS	RPM	SPD.	AMPS	ENCLOSURE	ROT.	BRNG.	SHAFT DIM.
D1144	3.3	1/25 - 1/35 - 1/65	115	1200	3	1.1-.9-.6	Open Vent.	CW	SLV	3/8 X 5 3/8
D1102	3.3	1/20	115/230	1550	1	.75-.4	Open Vent.	CW	SLV	5/16 X 2-5/8
D1129	3.3	1/20	115/230	1550	1	0.7/.35	Totally Encl.	CW	BALL	5/16 x 1 5/8
D1243	3.3	1/20	115	1550	1	0.8	Open Vent.	CCW	SLV	5/16 X 2 3/4
D1245	3.3	1/20	208-230	1550	1	0.3	Open Vent.	CCW	SLV	5/16 X 2 3/4
D218	3.91	1/20	115	3000	1	0.8	Totally Encl.	REV	BALL	5/16 X 2 1/4
D1122	3.3	1/16	208-230	1650/1300	1	0.4	Open Vent.	CW	SLV	5/16 X 1 5/8
D1182	3.3	1/16	208-230	3450	1	0.57	Open Vent.	CCW	SLV	5/16 X 3 1/3
D1184	3.3	1/16	460	3450	1	0.3	Open Vent.	CCW	BALL	5/16 X 3 1/3
D1186	3.3	1/16	460	3450	1	0.3	Open Vent.	CCW	BALL	5/16 X 3 1/3
D1176	3.3	1/15 - 1/25	115	1550	2	.9-.8	Totally Encl.	DS	SLV	4 7/8 X 3/8 X 4 7/8
D323	3.3	1/15 - 1/20 - 1/35	115	1550	3	1-.8-.6	Totally Encl.	DS	SLV	2 3/4 X 5/16 X 2 3/4
D1123	3.3	1/15	208-230	1550	1	0.5	Open Vent.	CCW	SLV	5/16 X 2 5/8
D1178	3.3	1/15	208-230	3450	1	0.45	Open Vent.	CW	BALL	1/4 X 2 3/4
D1125	3.3	1/12	208-230	1550	1	0.5	Open Vent.	CCW	SLV	5/16 X 2 5/8
D1140	3.3	1/10 - 1/12 - 1/15	115	1500	3	2.2-2-1.7	Open Vent.	DS	SLV	5-5/8 X 3/8 X 5 5/8
D326	3.3	1/10 - 1/20 - 1/25	115	1550	3	2.2-1.8-1.5	Open Vent.	DS	BALL	5 1/2 X 5/16 X 3
D404	3.3	1/10	208-230	3000	1	0.8	Open Vent.	REV	BALL	5/16 X 3 1/4
D405	3.3	1/10	115	3000	1	1.4	Open Vent.	REV	BALL	5/15 X 3 1/4
D410	3.3	1/10	115	3000	1	1.5	Open Vent.	REV	BALL	1/4 X 3 3/4
D503	3.3	1/10	230	1500	1	0.95	Open Vent.	REV	SLV	5/16 X 3 3/4
D412	3.3	1/9	230	3000	1	0.7	Open Vent.	REV	BALL	1/4 X 3 3/4
D219	3.91	1/8	115	3000	1	1.8	Totally Encl.	REV	BALL	5/16 X 2 1/4
D461	3.3	1/8	480	3200	1	0.32	Totally Encl.	CCW	SLV	5/16 X 3 1/3
D504	3.91	1/8	115/230	1500	1	1.6-.8	Open Vent.	REV	SLV	5/16 X 3 1/2

SP - 3.3" DIAMETER										
MODEL	DIA.	HP	VOLTS	RPM	SPD.	AMPS	ENCLOSURE	ROT.	BRNG.	SHAFT DIM.
D200	3.25	1/85	115	3000	1	0.6	Open Vent.	CW	SLV	2 3/8 X 1/4 X 3/4
D201	3.25	1/85	115	3000	1	0.6	Open Vent.	CCW	SLV	1/4 X 1 3/8
D429	3.3	9 Watts	115	1550	1	0.6	Totally Encl.	CCW	SLV	HUB
D431	3.3	9 Watts	230	1550	1	0.3	Totally Encl.	CCW	SLV	HUB
D437	3.3	16 Watts	115	1550	1	1.1	Totally Encl.	CCW	SLV	HUB
D1130	3.3	1/200	115	1550	1	0.5	Open Vent.	-	SLV	None
D107	3.3	1/160	208-240	600	1	0.5	Open Vent.	CCW	SLV	5/16 X 1
D408	3.3	1/150	115	3000	1	0.5	Open Vent.	CW	SLV	1/4 X 1 1/2
D1159	3.3	1/130	115	1500	1	0.45	Totally Encl.	CCW	SLV	5/16 X 1 1/8
D129	3.3	1/125 - 1/200	115	1500	2	.4 - .3	Open Vent.	DS	SLV	3 1/4 X 1/4 X 3 1/4
D1160	3.3	1/110	115	1480	1	0.58	Totally Encl.	CW	SLV	5/16 X 1-1/2
D1109	3.3	1/100	115	1500	1	0.65	Totally Encl.	CCW	SLV	1/4 X 1 1/4
D1155	3.3	1/100	115	1085	1	0.5	Totally Encl.	CCW	SLV	1/4 X 1
D1162	3.3	1/100	115	1500	1	0.6	Open Vent.	REV	SLV	5/16 X 1
D229	3.3	1/100	115	3000	1	0.55	Open Vent.	CCW	SLV	1/4 X 3 1/2
D230	3.3	1/100	115	3000	1	0.55	Open Vent.	CW	SLV	1/4 X 3 1/2
D540	3.3	1/100	115	1500	1	0.6	Totally Encl.	CW	SLV	1/4 X 2 1/4

SP - 3.3" DIAMETER										
MODEL	DIA.	HP	VOLTS	RPM	SPD.	AMPS	ENCLOSURE	ROT.	BRNG.	SHAFT DIM.
D541	3.3	1/100	115	1500	1	0.6	Totally Encl.	CCW	SLV	1/4 X 2 1/4
D1119	3.3	1/90	240	1500	1	0.34	Open Vent.	CCW	SLV	1/4 X 1 1/2
D202	3.3	1/85	115	3000	1	0.6	Open Vent.	CW	SLV	1/4 X 2 1/4
D122	3.3	1/80	115	1500	1	0.6	Totally Encl.	CW	SLV	1/4 X 2 1/4
D123	3.3	1/80	115	1500	1	0.6	Totally Encl.	CCW	SLV	1/4 X 2 1/4
D228	3.3	1/80	115	3000	1	0.8	Open Vent.	CW	SLV	1/4 X 2
D441	3.3	1/80	115	1500	1	0.6	Totally Encl.	CCW	SLV	1/4 X 1
D120	3.3	1/70	115	1500	1	0.7	Open Vent.	CW	SLV	1/4 X 2 1/4
D121	3.3	1/70	115	1500	1	0.7	Open Vent.	CCW	SLV	1/4 X 2 1/4
D167	3.3	1/70	115	1500	1	0.7	Open Vent.	CW	SLV	1/4 X 3
D169	3.3	1/70	115	1500	1	0.7	Open Vent.	CCW	SLV	1/4 X 3
D1117	3.3	1/65	115	1590	1	0.6	Open Vent.	CW	SLV	5/16 X 2 1/4
D182	3.3	1/60	115	1500	1	0.6	Totally Encl.	CW	SLV	5/16 X 2 1/4
D402	3.3	1/60	115	3000	1	0.75	Totally Encl.	CW	SLV	1/4 X 1 3/4
D403	3.3	1/60	115	3000	1	0.75	Totally Encl.	CCW	SLV	1/4 X 2 1/4
D1110	3.3	1/55	115	1300	1	.7	Open Vent.	CW	BALL	1/4 X 1 7/8
D1138	3.91	1/50 - 1/80 - 1/140	115	1500	3	.9-.6-.5	Open Vent.	CW	SLV	5/16 X 2 1/2
D1139	3.3	1/50 - 1/80 - 1/125	115	1500	3	0.88	Open Vent.	CW	SLV	2 1/2 X 5/16 X 1 1/8
D1134	3.3	1/50 - 1/65 - 1/80	115	1500	3	1.1-.8-.6	Open Vent.	CW	SLV	1/4 X 1 3/4
D1100	3.3	1/50	115	1550/900	2	1.2/.7	Open Vent.	CW	SLV	5/16 X 2 3/8
D1104	3.3	1/50	115	1550	1	.9	Open Vent.	DS	SLV	2.9 X 5/16 X 2.9
D124	3.3	1/50	115	1500	1	0.75	Totally Encl.	CW	SLV	1/4 X 2 1/4
D125	3.3	1/50	115	1500	1	0.75	Totally Encl.	CCW	SLV	1/4 X 2 1/4
D418	3.3	1/50	115	1550	1	1.1	Open Vent.	CW	BALL	1/4 X 3
D601	3.3	1/50	115	1500	1	0.9	Totally Encl.	CCW	SLV	1/4 X 2 1/4
D602	3.3	1/50	115	1500	1	0.9	Totally Encl.	CW	SLV	1/4 X 2 1/4
D603	3.3	1/50	115	1500	1	0.9	Open Vent.	CW	SLV	1/4 X 2 3/8
D608	3.3	1/50	230	3000	1	0.6	Open Vent.	CW	SLV	1/4 X 1 5/16
D609	3.3	1/50	115	1500	1	0.9	Open Vent.	CCW	SLV	1/4 X 2 1/4
D624	3.3	1/50	230	1500	1	0.4	Totally Encl.	CW	SLV	1/4 X 2 1/4
D205	3.3	1/40 - 1/70	115	3000	1	1-.5	Totally Encl.	DS	SLV	3 X 1/4 X 3
D128	3.3	1/40 - 1/50 - 1/80	115	1500	3	1.3-.9-.6	Open Vent.	DS	SLV	4 X 5/16 X 4
D106	3.3	1/40	115	1500	1	0.9	Open Vent.	CCW	SLV	1/4 X 1 3/4
D1151	3.3	1/40	115	1500	1	1.2	Totally Encl.	CCW	SLV	5/16 X 3 1/4
D1167	3.3	1/40	208-230	3000	1	0.55	Open Vent.	CCW	SLV	5/16 X 1
D1191	3.3	1/40	460	3200	1	0.37	Open Vent.	CCW	BALL	1/4 X 2 1/2
D1192	3.3	1/40	115	3000	1	0.7	Open Vent.	CCW	SLV	5/16 X 1 1/2
D126	3.3	1/40	115	1500	1	1.1	Open Vent.	CW	SLV	5/16 X 2 1/4
D127	3.3	1/40	115	1500	1	1	Open Vent.	CCW	SLV	5/16 X 2 1/4
D130	3.3	1/40	115	1500	1	1	Open Vent.	CW	SLV	5/16 X 4 1/8
D131	3.3	1/40	115	1500	1	1	Open Vent.	CCW	SLV	5/16 X 2 1/4
D190	3.3	1/40	230	1500	1	0.6	Open Vent.	CW	SLV	1/4 X 2 1/4
D203	3.3	1/40	115	3000	1	1	Open Vent.	CCW	SLV	1/4 X 2 1/4
D330	3.3	1/40	230	1500	1	0.5	Open Vent.	CW	SLV	5/16 X 2 1/4
D415	3.3	1/40	115	1550	1	1.1	Open Vent.	CCW	BALL	1/4 X 3
D105	3.3	1/37	115	1500	1	0.94	Open Vent.	CCW	SLV	1/4 X 1 1/2
D534	3.3	1/35 - 1/100	115	1500	2	1.4-.5	Totally Encl.	CW	SLV	1/4 X 1
D477	3.3	1/35	208-230	1550	1	0.75	Open Vent.	CCW	SLV	5/16 X 1 5/8
D1196	3.3	1/33	115	3200	1	1.5	Open Vent.	CCW	SLV	5/16 X 2 1/3
D137	3.3	1/30 - 1/65	115	1500	2	1-.7	Totally Encl.	DS	SLV	3 X 5/16 X 3
D181	3.3	1/30 - 1/40	115	1500	2	1.3-1	Open Vent.	CCW	SLV	5/16 X 2 1/4
D532	3.3	1/30 - 1/112	115	1500	2	1.4-.8	Open Vent.	CW	SLV	5/16 X 1 1/2
D1118	3.3	1/30	240	1500	1	0.6	Open Vent.	CW	BALL	5/16 X 3 1/2
D1173	3.3	1/30	115	1500	1	1.2	Open Vent.	CW	BALL	5/16 X 2 1/2
D1179	3.3	1/30	115	3000	1	1.5	Open Vent.	CW	SLV	5/16 X 2
D1190	3.3	1/30	115	3000	1	1.6	Open Vent.	CW	SLV	5/16 X 1 3/4
D1198	3.3	1/30	115	3200	1	1.5	Open Vent.	CCW	SLV	5/16 X 2 1/4
D136	3.3	1/30	115	1500	1	1.3	Open Vent.	DS	SLV	2 X 5/16 X 2
D206	3.3	1/30	115	3000	1	1.2	Open Vent.	CW	SLV	1/4 X 2 1/4
D207	3.3	1/30	230	3000	1	0.6	Open Vent.	DS	SLV	2 1/4 X 1/4 X 2 1/4

SP - 3.3" DIAMETER										
MODEL	DIA.	HP	VOLTS	RPM	SPD.	AMPS	ENCLOSURE	ROT.	BRNG.	SHAFT DIM.
D208	3.3	1/30	115	3000	1	1.1	Open Vent.	CW	SLV	1/4 X 3
D209	3.3	1/30	115	3000	1	1.1	Open Vent.	DS	SLV	3 1/4 X 1/4 X 3 1/4
D454	3.3	1/30	115	3000	1	1.5	Open Vent.	CW	SLV	1/4 X 1 1/2
D455	3.3	1/30	115/230	3000	1	1.3-.7	Open Vent.	CCW	BALL	1/4 X 3 7/8
D463	3.3	1/30	208-230	3000	1	0.65	Open Vent.	CW	BALL	5/16 X 2 1/2
D514	3.3	1/30	115	1500	1	1.3	Open Vent.	CW	SLV	5/16 X 2 1/4
D515	3.3	1/30	115	1500	1	1.3	Open Vent.	CCW	SLV	5/16 X 2 1/4
D332	3.3	1/25 - 1/65	115	1500	2	1.5-.8	Open Vent.	CW	SLV	5/16 X 2
D1164	3.3	1/25	115/230	1550	1	1.3-.65	Totally Encl.	CW	SLV	5/16 X 2 1/2
D1194	3.3	1/25	115	3200	1	1.7	Open Vent.	CW	BALL	5/16 X 1 1/3
D134	3.91	1/25	115	1500	1	1.6	Totally Encl.	CW	SLV	5/16 X 2 1/4
D135	3.91	1/25	115	1500	1	1.6	Totally Encl.	CCW	SLV	5/16 X 2 1/4
D138	3.91	1/25	115	1500	1	1.6	Totally Encl.	CW	SLV	5/16 X 2 5/8
D184	3.3	1/25	115	1500	1	1.2	Open Vent.	CW	SLV	5/16 X 1 7/8
D192	3.91	1/25	230	1500	1	0.9	Totally Encl.	CW	SLV	5/16 X 2 1/4
D210	3.3	1/25	115	3000	1	1.3	Open Vent.	CW	SLV	1/4 X 2 1/4
D216	3.3	1/25	230	3000	1	0.65	Open Vent.	CW	SLV	1/4 X 2 1/4
D222	3.81	1/25	115	1500	1	1.6	Totally Encl.	DS	SLV	2 1/4 X 5/16 X 2 1/4
D364	3.3	1/25	115	1500	1	1.8	Open Vent.	DS	SLV	1 7/8 X 5/16 X 1 7/8
D365	3.3	1/25	115	1500	1	1.8	Open Vent.	DS	SLV	1 7/8 X 5/16 X 1 7/8
D636	3.3	1/25	230	1500	1	0.69	Open Vent.	DS	SLV	2 1/4 X 5/16 X 2 1/4
D1193	3.3	1/22	115	3000	1	1.2	Open Vent.	CCW	SLV	5/16 X 2 1/3
D520	3.3	1/20 - 1/50 - 1/100	115	1500	3	2-1-.7	Totally Encl.	CW	SLV	1/4 X 2 1/4
D1101	3.3	1/20	115	1500	1	1.9	Open Vent.	CCW	SLV	5/16 X 2 1/4
D1103	3.3	1/20	208-230	1500	1	1.15	Open Vent.	CCW	SLV	5/16 X 2 1/4
D1121	3.3	1/20	208-230	1550	1	1	Open Vent.	CW	SLV	5/16 X 2 1/2
D1120	3.3	1/20	115	1550	1	2.1	Open Vent.	CW	SLV	5/16 X 2 1/2
D1124	3.3	1/20	115	1550	1	2.1	Open Vent.	CW	SLV	5/16 X 3
D1152	3.3	1/20	115	1500	1	1.7	Open Vent.	CW	SLV	5/16 X 2 3/8
D1154	3.3	1/20	230	1550	1	1	Open Vent.	CW	SLV	5/16 X 2 3/8
D1158	3.3	1/20	115/208-230	1550	1	1.4-.8	Open Vent.	CW	BALL	5/16 X 1 5/8
D1165	3.3	1/20	115	1550	1	2	Open Vent.	DS	SLV	3 1/2 X 5/16 X 3 1/2
D1180	3.3	1/20	115	3300	1	1.9	Open Vent.	CW	SLV	5/16 X 2 1/8
D1189	3.3	1/20	115/208-230	1550	1	1.4-.76	Totally Encl.	CW	BALL	5/16 X 1 5/8
D132	3.3	1/20	115	1500	1	1.8	Open Vent.	CW	SLV	5/16 X 2 1/4
D133	3.3	1/20	115	1500	1	1.8	Open Vent.	CCW	SLV	5/16 X 2 1/4
D186	3.3	1/20	460	1500	1	0.4	Open Vent.	CW	SLV	5/16 X 2 1/3
D188	3.3	1/20	230	1500	1	0.9	Open Vent.	CW	SLV	5/16 X 2 1/4
D189	3.3	1/20	230	1500	1	0.9	Open Vent.	CCW	SLV	5/16 X 2 1/4
D214	3.91	1/20	115/230	3000	1	1.7-.8	Totally Encl.	CW	SLV	5/16 X 6 1/2
D215	3.91	1/20	115/230	3000	1	1.7-.8	Totally Encl.	CCW	BALL	5/16 X 6 1/2
D220	3.91	1/20	115/230	3000	1	1.7-.8	Totally Encl.	CW	BALL	5/16 X 6 1/2
D226	3.91	1/20	115	1500	1	1.6	Totally Encl.	CW	BALL	5/16 X 2 1/4
D227	3.91	1/20	115	1500	1	1.7	Totally Encl.	CCW	BALL	5/16 X 2 1/4
D470	3.3	1/20	208-230	1550	1	0.94	Open Vent.	CW	SLV	5/16 X 2 5/8
D471	3.3	1/20	208-230	1550	1	1.1	Open Vent.	CCW	SLV	5/16 X 2 1/2
D472	3.3	1/20	115	1550	1	1.9	Open Vent.	CW	SLV	5/16 X 2 5/8
D473	3.3	1/20	115	1550	1	2	Open Vent.	CCW	SLV	5/16 X 2 5/8
D1111	3.3	1/18 - 1/30	115	1330	2	2.4-1.6	Open Vent.	CCW	SLV	3 1/8 X 5/16 X 2 3/8
D1161	3.3	1/15 - 1/25	115	1600	2	2.9-2	Open Vent.	CCW	SLV	5/16 X 2
D109	3.3	1/15	115	1600	1	2.1	Open Vent.	CW	SLV	5/16 X 3
D1126	3.3	1/15	208-230	1550	1	1.1	Open Vent.	CW	SLV	5/16 X 3
D1142	3.3	1/15	115/230	1500	1	1.7-.9	Open Vent.	CW	SLV	5/16 X 2 1/2
D1171	3.3	1/15	460	3000	1	0.6	Open Vent.	CCW	BALL	1/4 X 2 1/2
D1174	3.3	1/15	460	3000	1	0.6	Open Vent.	CW	BALL	1/4 X 2 1/2
D1188	3.3	1/15	208-230/460	3000	1	1.1-.6	Open Vent.	CW	BALL	5/16 X 2
D211	3.3	1/15	230	3000	1	1.1	Open Vent.	DS	SLV	2 1/2 X 1/4 X 2 1/2
D213	3.3	1/15	115	3000	1	2.1	Open Vent.	DS	SLV	2 3/4 X 1/4 X 2 3/4
D234	3.91	1/15	115	1500	1	2.2	Totally Encl.	CW	SLV	5/16 X 2 1/4

SP - 3.3" DIAMETER										
MODEL	DIA.	HP	VOLTS	RPM	SPD.	AMPS	ENCLOSURE	ROT.	BRNG.	SHAFT DIM.
D456	3.3	1/15	115/230	3000	1	2-1	Totally Encl.	CW	BALL	1/4 X 2 3/4
D457	3.3	1/15	115/230	3000	1	2-1	Open Vent.	CCW	BALL	1/4 X 2 3/4
D458	3.3	1/15	208-230	3000	1	1	Open Vent.	CW	BALL	1/4 X 2 3/4
D459	3.3	1/15	230/460	3000	1	1.2-.6	Open Vent.	CW	BALL	1/4 X 3
D475	3.3	1/15	460	1550	1	0.5	Open Vent.	CCW	SLV	5/16 X 2 1/2
D366	3.3	1/14 - 1/25	115	1550	2	2.5-1.5	Open Vent.	DS	SLV	6 3/8 X 5/16 X 6 3/8
D367	3.3	1/12 - 1/20 - 1/30	115	1550	3	3-2.1-1.7	Open Vent.	DS	SLV	5 3/4 X 5/16 X 5 3/4
D469	3.3	1/12	208-230	1550	1	1.3	Open Vent.	CCW	SLV	5/16 X 2 1/8
D1114	3.3	1/11	115	1250	1	.5	Open Vent.	CW	SLV	1/4 X 3 1/8
D325	3.3	1/10 - 1/30	115	1550	2	2.5-2.3	Open Vent.	CCW	SLV	1 3/4 X 5/16 X 2 3/8
D1107	3.3	1/10	115	1550	1	3.2	Open Vent.	CCW	BALL	5/16 X 1 3/8
D1169	3.3	1/10	208-230	3000	1	1.5	Open Vent.	CCW	SLV	5/16 X 1
D238	3.91	1/15	115	1500	1	2.3	Totally Encl.	CW	SLV	5/16 X 2 5/8
D334	3.91	1/15	230	1500	1	1.4	Totally Encl.	CW	BALL	5/16 X 3
D235	3.91	1/12	115	1580	1	2.2	Totally Encl.	CCW	SLV	5/16 X 2 1/4

SP - 4.4" DIAMETER										
MODEL	DIA.	HP	VOLTS	RPM	SPD.	AMPS	ENCLOSURE	ROT.	BRNG.	SHAFT DIM.
D333	4.4	1/25	115	1550	1	1.4	Open Vent.	DS	SLV	7 1/4 X 3/8 X 7 1/4
D1061	4.4	1/20 - 1/30 - 1/60	115	1500	3	2-1.7-1.4	Open Vent.	CCW	SLV	1/2 X 2 3/4
D335	4.4	1/20 - 1/30 - 1/40 - 1/60	115	1550	4	2.1-1.4-1.2-1.1	Open Vent.	DS	SLV	8 X 1/2 X 8
D170	4.4	1/20	115	1500	1	1.7	Open Vent.	CW	SLV	5/16 X 2 1/4
D484	4.4	1/20	115/208-230	1550	1	2.2-1.1	Open Vent.	CW	SLV	3/8 X 3 1/8
D485	4.4	1/20	115/208-230	1550	1	2.2-1.1	Open Vent.	CCW	SLV	3/8 X 3 1/8
D118	4.4	1/15 - 1/30	115	1500	2	2.4-1.4	Open Vent.	CW	SLV	3/8 X 2 3/8
D117	4.4	1/15 - 1/25 - 1/30 - 1/40	115	1550	4	2.4-1.4-1.1-.9	Open Vent.	CCW	SLV	1/2 X 7 1/2
D1012	4.4	1/15 - 1/20 - 1/25	115	1550	3	2.3-1.9-1.6	Totally Encl.	DS	SLV	3 X 3/8 X 3
D116	4.4	1/15	115	1500	1	2.4	Open Vent.	CW	SLV	3/8 X 2 3/8
D1170	4.4	1/15	115	1500	1	2.1	Open Vent.	CW	BALL	3/8 X 2 1/2
D1246	4.4	1/15	115	1550	1	2.3	Open Vent.	CCW	SLV	3/8 X 1 3/4
D312	4.4	1/15	115	1500	1	2.7	Open Vent.	CW	SLV	1/2 X 5
D329	4.4	1/15	115	1550	1	2.5	Open Vent.	DS	SLV	7 1/2 X 3/8 X 7 1/2
D482	4.4	1/15	115/208-230	1550	1	3.2-1.6	Open Vent.	CW	SLV	3/8 X 3 1/8
D483	4.4	1/15	115/208-230	1550	1	3.2-1.6	Open Vent.	CCW	SLV	3/8 X 3 1/8
D113	4.4	1/12	115/230	1550	1	2.5-1.3	Totally Encl.	CCW	SLV	3/8 X 3
D114	4.4	1/12	115/230	1550	1	2.5-1.3	Totally Encl.	CW	SLV	3/8 X 3
D115	4.4	1/12	115/230	1550	1	2.5-1.3	Totally Encl.	CCW	SLV	1/2 X 2
D310	4.4	1/12	115	1500	1	4	Open Vent.	CW	SLV	3/8 X 2
D377	4.4	1/12	115	1500	1	3.1	Open Vent.	CCW	SLV	3/8 X 2
D119	4.4	1/11 - 1/25 - 1/70	115	1500	3	2.9-1.5-1	Open Vent.	CCW	BALL	1/2 X 2 5/8
D635	4.4	1/10 - 1/20 - 1/35	230	1550	3	1.8-1.3-1	Open Vent.	DS	SLV	10 X 1/2 X 10
D236	4.4	1/10 - 1/15 - 1/25	115	1550	3	3.5-2.4-1.8	Open Vent.	DS	SLV	7 1/2 X 1/2 X 7 1/2
D336	4.4	1/10 - 1/15 - 1/25	115	1550	3	3.5-2.4-1.8	Open Vent.	DS	SLV	7 1/2 X 3/8 X 7 1/2
D674	4.4	1/10 - 1/15	230	1500	2	2-1.3	Open Vent.	CW	SLV	3/8 X 2 1/2
D1008	4.4	1/10	115	1500	1	4.4	Open Vent.	CW	SLV	1/2 X 1 3/4
D1039	4.4	1/10	115	1610	1	3.1	Open Vent.	CCW	SLV	1/2 X 2 3/8
D112	4.4	1/10	115	1500	1	3.6	Open Vent.	CW	SLV	3/8 X 2 5/8
D174	4.4	1/10	115	1500	1	3.5	Open Vent.	CW	SLV	3/8 X 2 7/8
D435	4.4	1/10	230	1500	1	1.7	Open Vent.	CCW	SLV	3/8 X 2 5/8
D480	4.4	1/10	115/208-230	1550	1	4.5-2.2	Open Vent.	CW	SLV	3/8 X 3 1/8
D481	4.4	1/10	115/208-230	1550	1	4.5-2.2	Open Vent.	CCW	SLV	3/8 X 3 1/8
D374	4.4	1/8 - 1/20	115	1500	2	4-2.5	Open Vent.	CW	SLV	3/8 X 2 1/2
D339	4.4	1/8 - 1/12	230	1550	2	2-1.4	Open Vent.	DS	SLV	6 1/2 X 1/2 X 6 1/2
D337	4.4	1/8 - 1/10 - 1/12 - 1/15	115	1550	4	4.1-2.7-2.3-1.9	Open Vent.	DS	SLV	7 1/2 X 1/2 X 7 1/2
D338	4.4	1/6 - 1/10 - 1/12 - 1/15	115	1550	4	5.4-3.2-2.5-2.1	Open Vent.	DS	SLV	7 1/4 X 1/2 X 7 1/4
D1006	4.4	1/4	115	1600	1	7.2	Open Vent.	CW	SLV	1/2 X 2 3/4

PSC -5.0" DIAMETER										
MODEL	DIA.	HP	VOLTS	RPM	SPD.	AMPS	ENCLOSURE	ROT.	BRNG.	SHAFT DIM.
D1045	5	1/30	115-127	1100	3	0.53	Open Vent.	CW	SLV	1/2 X 9
D1053	5	1/30	265	1075	3	0.38	Open Vent.	CW	SLV	1/2 X 7 1/8
D382	5	1/25 - 1/40 - 1/50	115	1550	3	.6-.4-.3	Open Vent.	DS	SLV	6 7/8 X 1/2 X 6 7/8
D1051	5	1/25 - 1/40	115	1060 - 500	2	.6-.4	Open Vent.	DS	SLV	11 1/8 X 1/2 X 11 1/8
D1056	5	1/20 - 1/30 - 1/40	208-230	1100	3	.4-.3-.2	Open Vent.	CW	SLV	1/2 X 3
D1058	5	1/20 - 1/30 - 1/40	265	1100	3	.5-.3-.2	Open Vent.	CW	SLV	1/2 X 2 1/2
D1062	5	1/20 - 1/30 - 1/40	265	1100	3	.4-.3-.2	Open Vent.	CW	SLV	1/2 X 3 1/2
D1047	5	1/20	208-230	1075	3	1.6	Open Vent.	CW	SLV	1/2 X 7 1/8
D1048	5	1/20	277	1075	3	0.5	Open Vent.	CW	SLV	1/2 X 7 1/4
D1049	5	1/20	265	1075	3	0.4	Open Vent.	CW	SLV	1/2 X 7 1/8
D488	5	1/20	115/208-230	1550	1	1.2-.6	Open Vent.	REV	SLV	3/8 X 3 1/3
D1041	5	1/15	265	1075	3	0.6	Open Vent.	CW	SLV	1/2 X 7 1/8
D1089	5	1/15	115	850	3	1.3	Open Vent.	REV	SLV	1/2 X 3
D1090	5	1/15	115	1100	3	0.8	Open Vent.	CW	SLV	10 1/2 X 1/2 X 11 1/2
D489	5	1/15	115/208-230	1550	1	1.2-.6	Open Vent.	REV	SLV	3/8 X 3 1/3
D1086	5	1/12 - 1/25	277	1625	2	.6-.2	Open Vent.	CCW	SLV	6 1/2 X 1/2 X 6 1/2
D1055	5	1/12	115-127	1375	3	1.4	Open Vent.	DS	SLV	9 1/8 X 1/2 X 9 1/2
D294	5	1/10 - 1/20 - 1/25 - 1/35 - 1/50	115	1050	5	1.3-1-.7-.6-.5	Open Vent.	DS	SLV	10 3/4 X 3/8 X 10 3/4
D290	5	1/10 - 1/15 - 1/25 - 1/40	115	1050	4	2.2-1.4-1-.7	Open Vent.	REV	SLV	1/2 X 8 1/2
D291	5	1/10 - 1/15 - 1/25 - 1/40	115	1050	4	2.2-1.4-1-.7	Open Vent.	DS	SLV	10 3/4 X 1/2 X 10 3/4
D292	5	1/10 - 1/15 - 1/25 - 1/35	208-230	1050	4	1-.7-.4-.3	Open Vent.	DS	SLV	10 3/4 X 1/2 X 10 3/4
D277	5	1/10 - 1/12 - 1/20	277	1050	3	.7-.5-.4	Open Vent.	DS	SLV	8 1/2 X 1/2 X 8 1/2
D1005	5	1/10	460	1075	2	0.5	Open Vent.	DS	SLV	9 5/8 X 1/2 X 9 5/8
G2243	5	1/10	208-230	1100	1	0.74	Totally Encl.	CWLE	BALL	
D474	5	1/10	115/208-230	1550	1	1.9-1	Open Vent.	REV	SLV	3/8 X 3 1/3
D486	5	1/10	115/208-230	1550	1	2.5-1.3	Open Vent.	REV	SLV	3/8 X 3 1/8
D487	5	1/10	115/208-230	1550	1	2.7-1.4	Open Vent.	REV	BALL	3/8 X 3 1/8
D497	5	1/10	115/208-230	1050	1	2-1	Open Vent.	REV	BALL	3/8 X 3 1/8
D261	5	1/8 - 1/15	115	1075	2	2.3-1.1	Totally Encl.	REV	SLV	1/2 X 3
D347	5	1/8 - 1/10 - 1/15 - 1/20	115	1550	4	2.3-1.6-1.2-.7	Open Vent.	DS	SLV	10 1/2 X 1/2 X 10 1/2
G2248	5	1/8	208-230	1075	1	0.86	Totally Encl.	CWLE	BALL	
G2249	5	1/8	208-230	1075	1	0.75	Totally Encl.	CCWLE	BALL	
D1050	5	1/8	230	1550	1	1.1	Open Vent.	CW	SLV	1/2 X 3
D1050	5	1/8	230	1550	1	1.1	Open Vent.	CW	SLV	1/2 X 3
D264	5	1/8	230	1550	1	1.1	Open Vent.	REV	SLV	1/2 X 5
D247	5	1/6 - 1/8 - 1/12	230	1550	3	1-.7-.5	Open Vent.	DS	SLV	8 X 1/2 X 8
D1081	5	1/6 - 1/8 - 1/10	115	1625	3	2.4-1.9-1.5	Totally Encl.	REV	SLV	3 1/2 X 1/2 X 3 5/8
D354	5	1/6 - 1/10 - 1/20	115	1050	3	2.8-1.8-1	Open Vent.	DS	SLV	8 1/2 X 1/2 X 8 1/2
D1059	5	1/6	115-127	1450	3	2.3	Open Vent.	DS	SLV	8 3/4 X 1/2 X 9
D1065	5	1/6	277	1600	1	0.9	Totally Encl.	CCW	SLV	1/2 X 2 1/2
G2247	5	1/6	208-230	1100	1	1.3	Totally Encl.	CCWLE	BALL	
D1071	5	1/6	208-230	1100	1	0.99	Totally Encl.	REV	SLV	1/2 X 2 1/8
D260	5	1/6	115	1075	1	2.9	Totally Encl.	CW	SLV	1/2 X 3
D1022	5	1/5 - 1/6 - 1/8	208-230	1100	3	1.6-1.1-1	Open Vent.	CW	SLV	2 3/8 X 1/2 X 2 3/4
D1033	5	1/5 - 1/6 - 1/8	208-230	1400	3	1.6-1.5-1.3	Open Vent.	DS	SLV	2 3/4 X 1/2 X 3 1/2
D258	5	1/5 - 1/10	208-230	1550	2	2.8-1.3	Open Vent.	DS	SLV	8 X 1/2 X 8
G2246	5	1/5	208-230	1080	1	1.6	Totally Encl.	CWLE	BALL	
D1032	5	1/5	208-230	1550	1	1.6	Open Vent.	DS	SLV	6 1/4 X 1/2 X 6 1/4
D1040	5	1/5	208/240	925	3	1.6	Open Vent.	CW	SLV	1/2 X 8
D1042	5	1/5	208-230	1075	1	1.2	Open Vent.	DS	SLV	6 1/2 X 1/2 X 6 1/2
D262	5	1/5	230	925	1	2.3	Open Vent.	REV	SLV	1/2 X 4
D152	5	1/4 - 1/5 - 1/6 - 1/8	277	1050	4	1.6-1.1-.9-.7	Open Vent.	REV	SLV	1/2 X 6
D150	5	1/4 - 1/5 - 1/6	115	1050	3	4.1-3.2-2.5	Open Vent.	REV	SLV	1/2 X 6
D151	5	1/4 - 1/5 - 1/6	230	1050	3	1.7-1.2-1	Open Vent.	REV	SLV	1/2 X 6
D1016	5	1/4	230	1100	1	2	Open Vent.	CW	SLV	1/2 X 4 1/8
D1043	5	1/4	265	1075	3	1.6	Open Vent.	CW	SLV	1/2 X 6 1/4
D1044	5	1/4	115	970	3	6	Open Vent.	CW	SLV	1/2 X 8
G2244	5	1/4	208-230	1075	1	1.7	Totally Encl.	CWLE	BALL	
G2245	5	1/4	208-230	1075	1	1.7	Totally Encl.	CCWLE	BALL	
D1091	5	1/4	208-230	1075	1	2.2	Open Vent.	CCW	SLV	1/2 X 2 3/4
D245	5	1/3 - 1/5	230	1050	2	2.9-1.7	Open Vent.	DS	SLV	8 X 1/2 X 8
D1025	5	1/3	208-230	1625	1	2.3	Open Vent.	DS	SLV	7 1/8 X 1/2 X 7 1/4

SP -5.0" DIAMETER										
MODEL	DIA.	HP	VOLTS	RPM	SPD.	AMPS	ENCLOSURE	ROT.	BRNG.	SHAFT DIM.
D249	5	1/50 - 1/80 - 1/160	115	1050	3	1.1-.6-.4	Open Vent.	DS	SLV	7 5/8 X 3/8 X 7 5/8
D340	5	1/40	115	1050	1	1.1	Totally Encl.	CW	SLV	3/8 X 2 5/8
D143	5	1/30 - 1/40	115	1050	2	1.5-1	Open Vent.	CCW	SLV	1/2 X 1 5/8
D250	5	1/25 - 1/50 - 1/80	115	1050	3	1.5-1-.6	Open Vent.	DS	SLV	8 X 3/8 X 8
D255	5	1/25 - 1/50 - 1/80	115	1050	3	1.5-1-.6	Open Vent.	DS	SLV	7 1/2 X 1/2 X 7 1/2
D655	5	1/25 - 1/40 - 1/70	230	1050	3	.7-.5-.3	Open Vent.	DS	SLV	10 X 1/2 X 10
D1038	5	1/25	115	1050	1	1.4	Open Vent.	CW	SLV	1/2 X 2 1/2
D252	5	1/20 - 1/40 - 1/70	115	1050	3	1.6-.8-.5	Open Vent.	DS	SLV	7 1/2 X 3/8 X 7 1/2
D253	5	1/20 - 1/40 - 1/50	115	1050	3	2.2-1.4-.8	Open Vent.	DS	SLV	7 1/2 X 1/2 X 7 1/2
D1036	5	1/20	115	1045	1	1.95	Open Vent.	CW	SLV	3/8 X 2 1/8
D242	5	1/20	115	1050	1	2	Totally Encl.	CW	SLV	3/8 X 3
D494	5	1/20	115/208-230	1050	1	3-1.6	Open Vent.	CW	SLV	3/8 X 3 1/8
D495	5	1/20	115/208-230	1050	1	3-1.6	Open Vent.	CCW	SLV	3/8 X 3 1/8
D251	5	1/15 - 1/35 - 1/50	208-230	1050	3	1.2-.5-.4	Open Vent.	DS	SLV	9 1/4 X 1/2 X 8 1/2
D254	5	1/15 - 1/30 - 1/50	115	1050	3	2.1-1.3-.8	Open Vent.	DS	SLV	8 X 3/8 X 8
D142	5	1/15 - 1/25	115	1050	2	2.6-1.6	Open Vent.	CW	SLV	3/8 X 2 3/8
D389	5	1/15 - 1/20 - 1/30 - 1/50	115	1050	4	2.4-1.6-1.1-.8	Open Vent.	DS	SLV	10 1/4 X 1/2 X 10 1/4
D257	5	1/15 - 1/20 - 1/25	277	1050	3	1.1-.7-.6	Totally Encl.	DS	SLV	9 X 1/2 X 9
D1001	5	1/15	115	1000	1	3.2	Open Vent.	CW	SLV	3/8 X 3 1/4
D140	5	1/15	115	1050	1	2.7	Open Vent.	CW	SLV	3/8 X 2 3/8
D342	5	1/15	115	1050	1	2.3	Open Vent.	CW	SLV	3/8 X 2 1/2
D492	5	1/15	115/208-230	1050	1	3.4-1.7	Open Vent.	CW	SLV	3/8 X 3 1/8
D493	5	1/15	115/208-230	1050	1	3.4-1.7	Open Vent.	CCW	SLV	3/8 X 3 1/8
D1054	5	1/12 - 1/20 - 1/25	115	1050	3	3.1-2.1-1.5	Open Vent.	CW	SLV	1/2 X 2 1/2
D1087	5	1/12	115	1050	1	2.9	Open Vent.	CW	SLV	1/2 X 2 1/3
D289	5	1/10 - 1/30 - 1/40 - 1/45 - 1/50	115	1050	5	3.6-1.6-1.2-.8-.6	Open Vent.	DS	SLV	10 3/4 X 1/2 X 10 3/4
D293	5	1/10 - 1/30 - 1/40 - 1/45 - 1/50	115	1050	5	3.6-1.6-1.2-.8-.6	Open Vent.	DS	SLV	10 3/4 X 3/8 X 10 3/4
D256	5	1/10 - 1/20 - 1/30	115	1050	3	3.4-1.7-1	Open Vent.	DS	SLV	8 X 1/2 X 8
D176	5	1/10 - 1/20	115	1050	2	3.9-1.7	Open Vent.	CW	SLV	3/8 X 3
D177	5	1/10 - 1/20	115	1050	2	3.9-1.7	Open Vent.	CCW	SLV	3/8 X 3 5/8
D1069	5	1/10 - 1/15	115	1040	2	3.5-2.2	Open Vent.	DS	SLV	3 X 3/8 X 3
D160	5	1/10 - 1/12 - 1/15	115	1050	3	3.4-2.8-2.4	Open Vent.	CW	SLV	3/8 X 3 7/8
D1066	5	1/10	115	1050	1	3.6	Open Vent.	CW	BALL	1/2 X 2 3/4
D144	5	1/10	115	1050	1	3.6	Open Vent.	CW	SLV	1/2 X 4 1/2
D148	5	1/10	115	1050	1	3.6	Open Vent.	CW	SLV	3/8 X 3 1/2
D154	5	1/10	115	1050	1	5	Open Vent.	CW	SLV	3/8 X 2 3/4
D490	5	1/10	115/208-230	1050	1	5-2.5	Open Vent.	CW	SLV	3/8 X 3 1/8
D491	5	1/10	115/208-230	1050	1	5-2.5	Open Vent.	CCW	SLV	3/8 X 3 1/8
D1066	5	1/10	115	1050	1	3.6	Open Vent.	CW	BALL	1/2 X 2 3/4
D314	5	1/8 - 1/15	230	1050	2	2.3-1.5	Open Vent.	CW	SLV	1/2 X 5
D1010	5	1/8 - 1/12 - 1/15	115	1050	3	4.4-3-2.3	Open Vent.	DS	SLV	3 1/3 X 1/2 X 2 3/4
D178	5	1/8 - 1/11	115	1050	2	4.5-3.4	Open Vent.	CW	SLV	1/2 X 4
D180	5	1/8 - 1/11	115	1050	2	4.5-3.4	Open Vent.	CW	SLV	1/2 X 4
D356	5	1/8 - 1/10 - 1/12	115	1050	3	4.7-3.7-3.2	Open Vent.	CW	SLV	1/2 X 3 1/2
D316	5	1/8 - 1/10	230	1050	2	2.1-1.8	Open Vent.	CW	SLV	1/2 X 3 1/2
D1028	5	1/8	115	1050	1	3.3	Open Vent.	CW	BALL	1/2 X 2 1/2
D1046	5	1/8	115	1070	1	5.1	Open Vent.	CW	SLV	1/2 X 2 1/4
D1082	5	1/8	115	1070	1	6	Open Vent.	CW	BALL	1/2 X 3 1/4
D656	5	1/8	230	1050	1	2.1	Open Vent.	CW	SLV	1/2 X 3 7/8
D166	5	1/6 - 1/9	115	1050	2	7.2-3.8	Open Vent.	CW	SLV	1/2 X 3 1/2
D224	5	1/6 - 1/8 - 1/12	230	1050	3	3.2-2.3-1.8	Open Vent.	DS	SLV	10 X 1/2 X 10
D164	5	1/6 - 1/8 - 1/10 - 1/2	115	1050	4	6.5-4.8-4.3-3.7	Open Vent.	CW	SLV	1/2 X 4 1/2
D318	5	1/6 - 1/8	230	1050	2	3.1-2.2	Open Vent.	CW	SLV	1/2 X 3 1/2
D1011	5	1/6 - 1/12 - 1/15	208-230	1050	3	2.5-1.6-1.2	Open Vent.	DS	SLV	3 1/3 X 1/2 X 2 3/4
D1080	5	1/6	115	1050	1	7.9	Open Vent.	CW	BALL	1/2 X 4
D156	5	1/6	115	1050	1	6.6	Open Vent.	CW	SLV	1/2 X 3 7/8
D240	5	1/6	115	1050	1	6.2	Open Vent.	CW	SLV	1/2 X 3 1/2
D158	5	1/5 - 1/6 - 1/7	115	1050	3	6.7-5.3-4.7	Open Vent.	CW	SLV	1/2 X 4 1/8
D658	5	1/5 - 1/6 - 1/7 - 1/8	208-230	1050	4	4-3.4-3.1-2.4	Open Vent.	CW	SLV	1/2 X 5 1/4

3 PH - 5.6" DIAMETER										
MODEL	DIA.	HP	VOLTS	RPM	SPD.	AMPS	ENCLOSURE	ROT.	BRNG.	SHAFT DIM.
D2720	5.6	3/4	200-230	1140	1	3	Open Vent.	REV	BALL	5/8 X 5 7/8 Keyed
D2721	5.6	3/4	460	1140	1	1.5	Open Vent.	REV	BALL	5/8 X 5 7/8 Keyed

PSC - 5.6" DIAMETER										
MODEL	DIA.	HP	VOLTS	RPM	SPD.	AMPS	ENCLOSURE	ROT.	BRNG.	SHAFT DIM.
D2844	5.6	1/10	208/230	825	1	0.8	Open Vent.	CW	SLV	1/2 X 4 1/4
D5459	5.6	1/8,1/6	208-230	1075	1	1.0	Totally Encl.	REV	SLV	1/2 X 6 3/4
D751	5.6	1/8 - 1/10 - 1/15	115	1075	3	2.3-1.5-1.1	Open Vent.	DS	SLV	7 1/2 X 1/2 X 9
D857	5.6	1/8 - 1/10 - 1/15	115	1100	3	1.7	Open Vent.	DS	SLV	3 1/8 X 1/2 X 4 1/8
D750	5.6	1/8 - 1/10 - 1/12	208-230	1075	3	.9-.6-.5	Open Vent.	DS	SLV	7 1/2 X 1/2 X 9
D799	5.6	1/8	208-230	825	1	0.9	Totally Encl.	REV	SLV	1/2 X 6
D827	5.6	1/8	115	700	1	2.5	Open Vent.	CCW	BALL	1/2 X 2
D832	5.6	1/8	208-230	825	1	1.1	Totally Encl.	REV	SLV	1/2 X 4 3/4
D847	5.6	1/8	208-230	1125	1	0.9	Totally Encl.	CCW	SLV	1/2 X 3 1/2
D895	5.6	1/8	208-230	1650	1	0.8	Totally Encl.	CW	SLV	1/2 X 1 1/2
D919	5.6	1/8	208-230	1075	1	0.9	Totally Encl.	REV	SLV	1/2 X 6 1/2
D5488	5.6	1/6-1/8	208-230	825	1	1	Totally Encl.	REV	BALL	1/2 X 6 5/8
D3752	5.6	1/6 - 1/8 - 1/10	230	900	3	1.2-.8-.6	Totally Encl.	DS	SLV	7 1/2 X 1/2 X 7 1/2
D3775	5.6	1/6 - 1/8 - 1/10	230	1350	3	.8-.6-.5	Totally Encl.	DS	SLV	7 3/4 X 1/2 X 7 3/4
D752	5.6	1/6 - 1/8 - 1/10	208-230	1075	3	1.4-.9-.5	Open Vent.	DS	SLV	7 1/2 X 1/2 X 9
D754	5.6	1/6 - 1/8 - 1/10	115	1075	3	2.7-2.1-1.7	Open Vent.	DS	SLV	7 1/2 X 1/2 X 9
D864	5.6	1/6 - 1/8 - 1/10	208-230	1040	3	1.3-1.2-1.1	Open Vent.	CW	SLV	2 1/8 X 1/2 X 7 1/4
D884	5.6	1/6 - 1/8 - 1/10	115	1050	3	2.3-2-1.8	Open Vent.	DS	SLV	5 X 1/2 X 4
D927	5.6	1/6 - 1/8 - 1/10	208-230	1075	3	1.4-.9-.5	Open Vent.	REV	SLV	1/2 X 7 1/2
D928	5.6	1/6 - 1/8 - 1/10	115	1075	3	2.7-2.1-1.7	Open Vent.	REV	SLV	1/2 X 5 1/4
D979	5.6	1/6 - 1/8 - 1/10	277	1075	3	.9-.7-.6	Open Vent.	DS	SLV	7 7/8 X 1/2 X 8 1/4
D733	5.6	1/6 - 1/8	115	1075	2	2.5-1.8	Totally Encl.	REV	BALL	1/2 X 4 1/2
D905	5.6	1/6 - 1/8	208-230	1075	2	1.2-.9	Totally Encl.	REV	SLV	1/2 X 6 1/2
D975	5.6	1/6 - 1/10 - 1/12	277	1075	3	.9-.4-.3	Open Vent.	REV	SLV	1/2 X 5 1/2
D2810	5.6	1/6	208-230	1100	1	1	Totally Encl.	CCW	SLV	1/2 X 2
D2842	5.6	1/6	208/230	825	1	1.2	Open Vent.	CW	SLV	1/2 X 4 1/4
D736	5.6	1/6	115	1625	1	2	Totally Encl.	REV	BALL	1/2 X 3 1/4
D793	5.6	1/6	208-230	825	1	1	Totally Encl.	REV	BALL	1/2 X 6
D798	5.6	1/6	208-230	825	1	1.3	Totally Encl.	REV	SLV	1/2 X 6
D807	5.6	1/6	208-230	1625	1	1.2	Open Vent.	CCW	BALL	1/2 X 4 7/8
D834	5.6	1/6	115	1075	1	2.7	Totally Encl.	CW	BALL	1/2 X 3
D894	5.6	1/6	277	1650	1	0.8	Open Vent.	CW	SLV	1/2 X 2 1/4
D917	5.6	1/6	208-230	1075	1	1	Totally Encl.	REV	SLV	1/2 X 6 1/2
D5458	5.6	1/5,1/4,1/3	208-230	1075	1	2.0	Totally Encl.	REV	SLV	1/2 X 6 3/4
D776	5.6	1/5 - 1/8 - 1/10	115	1625	3	2.8-2-1.6	Open Vent.	DS	SLV	8 1/2 X 1/2 X 8 1/2
D719	5.6	1/5 - 1/8	208-230	1075	2	1.3-.8	Open Vent.	REV	SLV	1/2 X 6 1/2
D896	5.6	1/5 - 1/8	208-230	1625	2	1.1-.7	Totally Encl.	CCWLE	SLV	2 7/8 X 1/2 X 2 1/4
D897	5.6	1/5 - 1/6 - 1/8 - 1/10	230	1075	4	1.5-1.1-1-.8	Open Vent.	CW	SLV	2 3/8 X 1/2 X 2 1/2
D775	5.6	1/5 - 1/6 - 1/8	208-230	1625	3	1.1-.8-.7	Open Vent.	DS	SLV	8 1/2 X 1/2 X 8 1/2
D848	5.6	1/5 - 1/6 - 1/8	265-277	1040	3	1.1-.8-.7	Open Vent.	CW	SLV	3 X 1/2 X 7
D2840	5.6	1/5	208/230	1075	1	1.3	Totally Encl.	CW	SLV	1/2 X 4 1/8
D720	5.6	1/5	208-230	1075	1	1.5	Open Vent.	REV	SLV	1/2 X 6
D743	5.6	1/5	208-230	1075	1	1.2	Open Vent.	REV	SLV	1/2 X 6
D794	5.6	1/5	208-230	825	1	1.3	Totally Encl.	REV	SLV	1/2 X 6
D842	5.6	1/5	230	1075	1	1.3	Open Vent.	CW	SLV	1/2 X 3 X 1/4
D882	5.6	1/5	230	1080	1	1.5	Open Vent.	CW	SLV	1/2 X 4 1/4
D906	5.6	1/5	208-230	1075	1	1.2	Totally Encl.	REV	SLV	1/2 X 6 1/2
D1702	5.6	1/4 - 1/8	208-230	1075	2	1.7-.8	Totally Encl.	REV	BALL	1/2 X 6
D824	5.6	1/4 - 1/8	115	1100	2	3.2-2.4	Totally Encl.	REV	BALL	1/2 X 3 1/2
D1703	5.6	1/4 - 1/6 - 1/8	115	1075	3	4.1- 3-2.3	Totally Encl.	DS	SLV	8 X 1/2 X 8
D1706	5.6	1/4 - 1/6 - 1/8	208-230	1075	3	1.7-1.3-1	Totally Encl.	DS	SLV	8 X 1/2 X 8
D725	5.6	1/4 - 1/6 - 1/8	208-230	1075	3	2.2-1.5-1.1	Open Vent.	REV	SLV	1/2 X 6
D755	5.6	1/4 - 1/6 - 1/8	208-230	1075	3	2-1.4-1.2	Open Vent.	DS	SLV	7 1/2 X 1/2 X 8 1/2
D756	5.6	1/4 - 1/6 - 1/8	115	1075	3	3.9-2.4-2.1	Open Vent.	DS	SLV	10 X 1/2 X 10
D766	5.6	1/4 - 1/6 - 1/8	230	1075	3	1.9-1.2-.8	Totally Encl.	DS	SLV	7 1/2 X 1/2 X 8 1/2
D973	5.6	1/4 - 1/6 - 1/8	277	1075	3	2-1.4-1	Open Vent.	REV	SLV	1/2 X 5 1/2
D739	5.6	1/4 - 1/6	208-230	1075	2	2-1.3	Open Vent.	REV	BALL	1/2 X 6
D918	5.6	1/4 - 1/6	460	1625	2	1/6	Open Vent.	REV	BALL	1/2 X 6 1/2

PSC - 5.6" DIAMETER										
MODEL	DIA.	HP	VOLTS	RPM	SPD.	AMPS	ENCLOSURE	ROT.	BRNG.	SHAFT DIM.
D1730	5.6	1/4 - 1/5 - 1/6	115	1075	3	4.8-3.3-2.6	Open Vent.	REV	SLV	1/2 X 6
D1733	5.6	1/4 - 1/5 - 1/6	208-230	1075	3	2.2-1.6-1.2	Open Vent.	REV	SLV	1/2 X 6
D3755	5.6	1/4 - 1/5 - 1/6	230	900	3	2-1.4-1	Totally Encl.	DS	SLV	7 1/4 X 1/2 X 7 1/4
D3774	5.6	1/4 - 1/5 - 1/6	230	1350	3	1.5-1.1-.8	Totally Encl.	DS	SLV	7 1/2 X 1/2 X 7 1/2
D721	5.6	1/4 - 1/5 - 1/6	115	1075	3	4.8-3.3-2.6	Open Vent.	REV	SLV	1/2 X 6
D773	5.6	1/4 - 1/5 - 1/6	115	1625	3	3.8-2.8-2.1	Open Vent.	DS	SLV	8 1/2 X 1/2 X 8 1/2
D774	5.6	1/4 - 1/5 - 1/6	208-230	1625	3	1.9-1.2-.9	Open Vent.	DS	SLV	8 1/2 X 1/2 X 8 1/2
D843	5.6	1/4 - 1/5	208-230	1075	1	2.2-2	Open Vent.	REV	SLV	1/2 X 4 1/4
D904	5.6	1/4 - 1/5	208-230	1075	2	1.8-1	Totally Encl.	REV	SLV	1/2 X 6 1/2
D1749	5.6	1/4	208-230	1075	1	2.1	Open Vent.	REV	SLV	1/2 X 6
D734	5.6	1/4	115	1075	1	3.8	Totally Encl.	REV	BALL	1/2 X 3 1/4
D742	5.6	1/4	208-230	1075	1	2.1	Open Vent.	REV	SLV	1/2 X 6
D749	5.6	1/4	208-230	1075	1	1.8	Open Vent.	REV	SLV	1/2 X 6 1/2
D7749	5.6	1/4	208-230	1075	1	1.7	Open Vent.	REV	BALL	1/2 X 6 1/2
D782	5.6	1/4	115	1625	1	3.5	Open Vent.	REV	SLV	1/2 X 6
D783	5.6	1/4	208-230	1625	1	1.5	Open Vent.	REV	SLV	1/2 X 6
D7909	5.6	1/4	208-230	1075	1	1.8	Totally Encl.	REV	BALL	1/2 X 6 1/2
D792	5.6	1/4	208-230	825	1	1.8	Open Vent.	REV	BALL	1/2 X 6
D797	5.6	1/4	208-230	825	1	1.8	Open Vent.	REV	SLV	1/2 X 6
D829	5.6	1/4	115	825	1	3.8	Open Vent.	REV	SLV	1/2 X 2
D844	5.6	1/4	230	1625	1	1.5	Open Vent.	CW	SLV	1/2 X 3
D870	5.6	1/4	230	1625	1	1.9	Open Vent.	CW	BALL	1/2 X 3
D880	5.6	1/4	115	1050	1	4.3	Open Vent.	CCW	BALL	1/2 X 1 1/2
D909	5.6	1/4	208-230	1075	1	1.8	Totally Encl.	REV	SLV	1/2 X 6 1/2
D913	5.6	1/4	460	1075	1	1.1	Open Vent.	REV	BALL	1/2 X 6 3/8
D922	5.6	1/4	208-230	1075	1	1.8	Totally Encl.	REV	SLV	1/2 X 6 1/2
D934	5.6	1/4	208-230	825	1	1.9	Totally Encl.	REV	SLV	1/2 X 6
D939	5.6	1/4	208-230	1075	1	2.1	Open Vent.	REV	BALL	1/2 X 6
D980	5.6	1/4	460	1075	1	1	Totally Encl.	REV	BALL	1/2 X 6
D5489	5.6	1/3-1/4	208-230	825	1	1.8	Totally Encl.	REV	BALL	1/2 X 6 5/8
D901	5.6	1/3 - 1/8	115	1100	2	4-3.5	Totally Encl.	REV	BALL	1/2 X 3 1/2
D859	5.6	1/3 - 1/5 - 1/8	230	1100	3	1.7-1.5-1.3	Open Vent.	DS	SLV	4 1/4 X 1/2 X 5 1/4
D818	5.6	1/3 - 1/5 - 1/6	115	825	3	7.3-5.1-3.9	Open Vent.	CW	SLV	1/2 X 3
D812	5.6	1/3 - 1/4 - 1/6 - 1/8	115	1075	4	6.1-3.2-2.2-1.6	Open Vent.	CW	SLV	1/2 X 3 1/8
D1704	5.6	1/3 - 1/4 - 1/6	115	1075	3	4.9-3.1-2.2	Totally Encl.	DS	SLV	8 X 1/2 X 8
D1707	5.6	1/3 - 1/4 - 1/6	230	1075	3	2.3-1.5-1.1	Totally Encl.	DS	SLV	8 X 1/2 X 8
D723	5.6	1/3 - 1/4 - 1/6	208-230	1075	3	3.3-2.3-1.8	Open Vent.	REV	SLV	1/2 X 6
D757	5.6	1/3 - 1/4 - 1/6	115	1075	3	6.9-4.8-3.8	Open Vent.	DS	SLV	8 1/2 X 1/2 X 8 1/2
D758	5.6	1/3 - 1/4 - 1/6	208-230	1075	3	2.3-1.7-1.1	Open Vent.	DS	SLV	8 1/2 X 1/2 X 8 1/2
D770	5.6	1/3 - 1/4 - 1/6	115	1625	3	5.9-4.4-3.5	Open Vent.	DS	SLV	8 3/4 X 1/2 X 8 3/4
D771	5.6	1/3 - 1/4 - 1/6	208-230	1625	3	2.4-1.8-1.4	Open Vent.	DS	SLV	8 3/4 X 1/2 X 8 3/4
D780	5.6	1/3 - 1/4 - 1/6	115	1625	3	4.7-3.5-2.7	Open Vent.	REV	SLV	1/2 X 6
D781	5.6	1/3 - 1/4 - 1/6	208-230	1625	3	2-1.6-1.2	Open Vent.	REV	SLV	1/2 X 7
D854	5.6	1/3 - 1/4 - 1/6	208-230	1365	3	2.8-1.7-1.2	Open Vent.	CCW	SLV	4 1/2 X 1/2 X 2 5/8
D868	5.6	1/3 - 1/4 - 1/5 - 1/6 - 1/7	230	1075	5	2.1-1.5-1.2-1-.9	Totally Encl.	CCW	SLV	2 3/4 X 1/2 X 2 1/4
D1731	5.6	1/3 - 1/4 - 1/5	115	1075	3	5.9-4.6-3.8	Open Vent.	REV	SLV	1/2 X 6
D1734	5.6	1/3 - 1/4 - 1/5	208-230	1075	3	2.8-2.2-1.8	Open Vent.	REV	SLV	1/2 X 6
D3758	5.6	1/3 - 1/4 - 1/5	230	900	3	2.6-1.7-1.3	Open Vent.	DS	SLV	7 X 1/2 X 6 3/4
D3771	5.6	1/3 - 1/4 - 1/5	230	1350	3	2.1-1.5-1.1	Open Vent.	DS	SLV	7 1/4 X 1/2 X 7 1/4
D727	5.6	1/3 - 1/4 - 1/5	115	1075	3	5.9-4.6-3.8	Open Vent.	REV	SLV	1/2 X 6
D855	5.6	1/3 - 1/4 - 1/5	230	1365	3	2.7-2-1.7	Open Vent.	DS	SLV	8 X 1/2 X 8 3/4
D856	5.6	1/3 - 1/4 - 1/5	230	1300	3	3.1	Open Vent.	CW	SLV	5 1/4 X 1/2 X 3
D923	5.6	1/3 - 1/4 - 1/5	208-230	1075	3	2.9-2.2-1.7	Open Vent.	REV	SLV	1/2 X 6
D972	5.6	1/3 - 1/4 - 1/5	277	1075	3	2.4-1.5-1	Open Vent.	REV	SLV	1/2 X 5 1/2
D1853	5.6	1/3 - 1/4 - 1/5	230	1090	3	2-1.9-1.8	Open Vent.	CW	SLV	6 X 1/2 X 2 7/8
D1701	5.6	1/3 - 1/4	208-230	1075	2	2.2-1.3	Totally Encl.	REV	BALL	1/2 X 5 1/2
D737	5.6	1/3 - 1/4	208-230	1075	2	3.5-1.9	Open Vent.	REV	BALL	1/2 X 6
D744	5.6	1/3 - 1/4	208-230	1075	2	3.2-2.4	Open Vent.	REV	SLV	1/2 X 6 1/2
D803	5.6	1/3 - 1/4	230	1075	2	2.6-2.2	Open Vent.	REV	SLV	1/2 X 3 1/2
D820	5.6	1/3 - 1/4	120	1050	2	4.8-4.5	Open Vent.	REV	SLV	1/2 X 2
D821	5.6	1/3 - 1/4	460	1075	2	1.2/1	Open Vent.	REV	BALL	1/2 X 6
D903	5.6	1/3 - 1/4	208-230	1075	2	2.7-1.3	Totally Encl.	REV	SLV	1/2 X 6 1/2
D1748	5.6	1/3	208-230	1075	1	2.9	Open Vent.	REV	SLV	1/2 X 6 1/2
D2751	5.6	1/3	575	1100	1	.75	Open Vent.	REV	BALL	1/2 X 6 1/2

PSC - 5.6" DIAMETER										
MODEL	DIA.	HP	VOLTS	RPM	SPD.	AMPS	ENCLOSURE	ROT.	BRNG.	SHAFT DIM.
D2817	5.6	1/3	230	825	1	3.2	Open Vent.	REV	SLV	1/2 X 6
D2826	5.6	1/3	208-230	825		1.9	Totally Encl.	REV	BALL	1/2 X 5
D2827	5.6	1/3	208-230	1075		3.0	Totally Encl.	REV	BALL	1/2 X 5
D2834	5.6	1/3	208/230	1075	1	2	Totally Encl.	CW	SLV	1/2 X 4 1/4
D732	5.6	1/3	115	1075	1	4.1	Totally Encl.	REV	BALL	1/2 X 5
D748	5.6	1/3	208-230	1075	1	2.9	Open Vent.	REV	SLV	1/2 X 6 1/2
D7748	5.6	1/3	208-230	1075	1	2.9	Open Vent.	REV	BALL	1/2 X 6 1/2
D787	5.6	1/3	208-230	1625	1	2.3	Open Vent.	REV	SLV	1/2 X 7
D7908	5.6	1/3	208-230	1075	1	2.6	Totally Encl.	REV	BALL	1/2 X 6 1/2
D791	5.6	1/3	208-230	825	1	2.6	Open Vent.	REV	BALL	1/2 X 6
D795	5.6	1/3	115	825	1	6.1	Open Vent.	REV	BALL	1/2 X 6
D796	5.6	1/3	208-230	825	1	2.6	Open Vent.	REV	SLV	1/2 X 6
D801	5.6	1/3	208-230	1625	1	2.9	Open Vent.	CCW	SLV	1/2 X 4
D816	5.6	1/3	208-230	1075	1	2.2	Totally Encl.	CW	SLV	1/2 X 3 3/4
D837	5.6	1/3	208-230	1075		2.6	Totally Encl.	REV	SLV	1/2 X 3 3/4
D908	5.6	1/3	208-230	1075	1	2.4	Totally Encl.	REV	SLV	1/2 X 6 1/2
D912	5.6	1/3	460	1075	1	1.1	Open Vent.	REV	BALL	1/2 X 6 3/8
D921	5.6	1/3	230/460	825	1	2.7/1.4	Open Vent.	REV	BALL	1/2 X 6 3/8
D925	5.6	1/3	208-230	1075	1	2.7	Totally Encl.	REV	SLV	1/2 X 6 1/2
D936	5.6	1/3	208-230	825	1	2	Totally Encl.	REV	SLV	1/2 X 6
D944	5.6	1/3	208-230	1075	1	2.9	Open Vent.	REV	SLV	1/2 X 6
D960	5.6	1/3	460	825	1	1.3	Open Vent.	REV	BALL	1/2 X 6
D966	5.6	1/3	460	1075	1	1.5	Open Vent.	REV	SLV	1/2 X 6 1/2
D982	5.6	1/3	460	1075	1	1.2	Totally Encl.	REV	BALL	1/2 X 6 1/2
D900	5.6	1/2 - 1/4	115	1100	2	7.1-4	Totally Encl.	REV	SLV	5/8 X 3
D997	5.6	1/2 - 1/4	115	1100	2	7.1-4	Totally Encl.	REV	SLV	1/2 X 3
D999	5.6	1/2 - 1/4	115	1100	2	7.1-4	Totally Encl.	REV	SLV	5/8 X 3
D701	5.6	1/2 - 1/3 - 1/4 - 1/5	115	1075	4	7.7-5.5-4.2-3.3	Open Vent.	REV	SLV	1/2 X 5 1/2
D806	5.6	1/2 - 1/3 - 1/4 - 1/5	115	1075	4	7.3	Open Vent.	REV	SLV	1/2 X 3 3/4
D902	5.6	1/2 - 1/3 - 1/4 - 1/5	115	1075	4	9.9-5.6-3.7-2.7	Open Vent.	REV	SLV	1/2 X 5 1/2
D1705	5.6	1/2 - 1/3 - 1/4	115	1075	3	8.7-6.2-4.9	Totally Encl.	DS	SLV	8 X 1/2 X 8
D1708	5.6	1/2 - 1/3 - 1/4	230	1075	3	4.1 - 3-2.3	Totally Encl.	DS	SLV	8 X 1/2 X 8
D1732	5.6	1/2 - 1/3 - 1/4	115	1075	3	7.7-5.5-4.2	Open Vent.	REV	SLV	1/2 X 6
D1735	5.6	1/2 - 1/3 - 1/4	208-230	1075	3	3.4-2.5-1.9	Open Vent.	REV	SLV	1/2 X 6
D2700	5.6	1/2 - 1/3 - 1/4	115	1075	3	7.7/5.5/4.2	Open Vent.	REV	BALL	1/2 X 5 1/2
D2701	5.6	1/2 - 1/3 - 1/4	208/230	1075	3	4.0/2.7/2.0	Open Vent.	REV	BALL	1/2 X 6 1/4
D3760	5.6	1/2 - 1/3 - 1/4	230	900	3	4.2-2.2-1.5	Open Vent.	DS	SLV	7 X 1/2 X 7
D3772	5.6	1/2 - 1/3 - 1/4	230	1350	3	3-1.9-1.3	Open Vent.	DS	SLV	7 X 1/2 X 7
D703	5.6	1/2 - 1/3 - 1/4	208-230	1075	3	4-2.7-2	Open Vent.	REV	SLV	1/2 X 6
D760	5.6	1/2 - 1/3 - 1/4	208-230	1075	3	4.3-3.1-2.3	Open Vent.	DS	SLV	8 X 1/2 X 8
D761	5.6	1/2 - 1/3 - 1/4	115	1075	3	9.6-6-4.4	Open Vent.	DS	SLV	8 X 1/2 X 8
D772	5.6	1/2 - 1/3 - 1/4	208-230	1625	3	3.8-2.8-2.1	Open Vent.	DS	SLV	8 X 1/2 X 8
D777	5.6	1/2 - 1/3 - 1/4	115	1625	3	9.4-6-4.5	Open Vent.	DS	SLV	7 1/2 X 1/2 X 7 1/2
D784	5.6	1/2 - 1/3 - 1/4	208-230	1625	3	3.8-2.8-2.1	Open Vent.	REV	SLV	1/2 X 6
D785	5.6	1/2 - 1/3 - 1/4	115	1625	3	8.4-6.4-5	Open Vent.	REV	SLV	1/2 X 6
D860	5.6	1/2 - 1/3 - 1/4	230	1075	3	3.2	Open Vent.	DS	SLV	4 1/4 X 1/2 X 4 3/8
D971	5.6	1/2 - 1/3 - 1/4	277	1075	3	3.2-2.2-1.8	Open Vent.	REV	SLV	1/2 X 5 1/2
D974	5.6	1/2 - 1/3 - 1/4	277	825	3	2.3-1.6-1.3	Open Vent.	REV	SLV	1/2 X 5
D976	5.6	1/2 - 1/3 - 1/4	277	1075	3	3.4-2.2-1.6	Open Vent.	DS	SLV	7 3/8 X 1/2 X 7 1/4
D1700	5.6	1/2 - 1/3	208-230	1075	2	3.7-1.9	Totally Encl.	REV	BALL	1/2 X 5 1/2
D735	5.6	1/2 - 1/3	208-230	1075	2	4.4-2.7	Open Vent.	REV	BALL	1/2 X 6
D862	5.6	1/2 - 1/3	208-230	1075	2	3.2-3	Open Vent.	DS	SLV	2 5/8 X 1/2 X 2 1/2
D916	5.6	1/2 - 1/3	460	1625	2	1.6/1.1	Open Vent.	REV	BALL	1/2 X 6 1/2
D1745	5.6	1/2	208-230	1075	1	4.1	Open Vent.	REV	SLV	1/2 X 6 1/2
D1911	5.6	1/2	460	1075	1	1.8	Open Vent.	REV	BALL	1/2 X 6 3/8
D2729	5.6	1/2	200-230/460	1075	1	4.6/2.3	Open Vent.	REV	BALL	1/2 X 3 1/2
D2750	5.6	1/2	575	1625	1	1	Open Vent.	REV	BALL	1/2 X 6 1/2
D2800	5.6	1/2	208/230	1075	1	2.9	Totally Encl.	REV	SLV	1/2 X 5
D2814	5.6	1/2	230	1050	1	2.6	Open Vent.	CW	BALL	1/2 X 3 1/4
D2832	5.6	1/2	115	1075		6.6	Open Vent.	REV	SLV	1/2 X 5
D2833	5.6	1/2	208-230	1075		3.7	Open Vent.	REV	SLV	1/2 X 5 1/2
D2835	5.6	1/2	115	1075		7.3	Open Vent.	REV	SLV	1/2 X 3 3/4
D2862	5.6	1/2	208-230	1075	1	4	Open Vent.	REV	BALL	1/2 X 3
D713	5.6	1/2	208-230	825	1	3.0	Totally Encl.	REV	SLV	1/2 X 6

PSC - 5.6" DIAMETER										
MODEL	DIA.	HP	VOLTS	RPM	SPD.	AMPS	ENCLOSURE	ROT.	BRNG.	SHAFT DIM.
D740	5.6	1/2	208-230	1075	1	4.5	Open Vent.	REV	SLV	1/2 X 6 1/2
D745	5.6	1/2	208-230	1075	1	4.1	Open Vent.	REV	SLV	1/2 X 6 1/2
D7745	5.6	1/2	208-230	1075	1	3.7	Open Vent.	REV	BALL	1/2 X 6 1/2
D788	5.6	1/2	208-230	1625	1	3.9	Open Vent.	REV	SLV	1/2 X 6
D790	5.6	1/2	208-230	825	1	3.5	Open Vent.	REV	BALL	1/2 X 6
D7907	5.6	1/2	208-230	1075	1	3.7	Totally Encl.	REV	BALL	1/2 X 6 1/2
D802	5.6	1/2	460	1050	1	0.9	Totally Encl.	REV	BALL	1/2 X 3 1/3
D817	5.6	1/2	115	1140	1	5.5	Totally Encl.	CW	BALL	1/2 X 6
D819	5.6	1/2	208-230/460	1075	1	4-2	Open Vent.	REV	BALL	1/2 X 3
D833	5.6	1/2	208-230	1075		3.6	Open Vent.	REV	BALL	1/2 X 4 1/2
D863	5.6	1/2	208-230	1075	1	4	Open Vent.	REV	BALL	1/2 X 3
D873	5.6	1/2	230	1050	1	3.2	Open Vent.	DS	SLV	9 3/4 X 1/2 X 9 3/4
D890	5.6	1/2	208-230	1725	1	2.7	Open Vent.	CCW	SLV	1/2 X 3 1/2
D907	5.6	1/2	208-230	1075	1	3.7	Totally Encl.	REV	SLV	1/2 X 6 1/2
D911	5.6	1/2	460	1075	1	1.8	Open Vent.	REV	BALL	1/2 X 6 3/8
D920	5.6	1/2	460	825	1	2.1	Open Vent.	REV	SLV	1/2 X 4 1/2
D932	5.6	1/2	208-230	1075	1	3.9	Totally Encl.	REV	SLV	1/2 X 6 1/2
D935	5.6	1/2	208-230	1075	1	4.1	Open Vent.	REV	BALL	1/2 X 6 1/2
D938	5.6	1/2	208-230	825	1	3.4	Open Vent.	REV	SLV	1/2 X 6
D961	5.6	1/2	460	825	1	1.9	Open Vent.	REV	BALL	1/2 X 6
D967	5.6	1/2	460	1075	1	1.6	Open Vent.	REV	SLV	1/2 X 6
D998	5.6	1/2	115/230	825	1	6-3	Totally Encl.	CW	BALL	5/8 X 2 5/8
D2818	5.6	3/4 - 1/3	230	1075	2	5-2.2	Open Vent.	REV	BALL	5/8 X 4 1/2 Keyed
D726	5.6	3/4 - 1/3	115	1075	2	11-5	Open Vent.	REV	SLV	5/8 X 4 1/2 Keyed
D930	5.6	3/4 - 1/3	208-230	1075	2	4.4-2.1	Open Vent.	REV	BALL	1/2 X 6 1/4
D951	5.6	3/4 - 1/3	208-230	1075	2	5-2.2	Open Vent.	REV	BALL	5/8 X 4 1/2 Keyed
D724	5.6	3/4 - 1/2 - 1/3 - 1/4	115	1075	4	9.5-7.2-5.6-3.5	Open Vent.	REV	SLV	1/2 X 6
D838	5.6	3/4 - 1/2 - 1/3 - 1/4	115	1075	4	11.2-9.7-7.5-6.4	Open Vent.	REV	SLV	1/2 X 6 1/2
D2702	5.6	3/4 - 1/2 - 1/3	115	1075	3	10.5/5.6/4.8	Open Vent.	REV	BALL	1/2 X 6 1/4
D2703	5.6	3/4 - 1/2 - 1/3	208/230	1075	3	5.4/3.8/2.9	Open Vent.	REV	BALL	1/2 X 6 1/4
D728	5.6	3/4 - 1/2 - 1/3	115	1075	3	10.5-6.9-4.8	Open Vent.	REV	SLV	1/2 X 6
D729	5.6	3/4 - 1/2 - 1/3	208-230	1075	3	5.4-3.8-2.9	Open Vent.	REV	SLV	1/2 X 6
D763	5.6	3/4 - 1/2 - 1/3	208-230	1075	3	5.7-4.1-3.1	Open Vent.	DS	SLV	8 X 1/2 X 8
D769	5.6	3/4 - 1/2 - 1/3	115	1075	3	11.9-8.1-6	Open Vent.	DS	SLV	8 X 1/2 X 8
D778	5.6	3/4 - 1/2 - 1/3	208-230	1625	3	5.3-3.8-3.2	Open Vent.	DS	SLV	7 1/2 X 1/2 X 7
D786	5.6	3/4 - 1/2 - 1/3	230	1625	3	5.3-3.8-2.9	Open Vent.	REV	SLV	1/2 X 6
D813	5.6	3/4 - 1/2 - 1/3	230	1075	3	5.9-3-2.4	Open Vent.	DS	SLV	5 1/4 X 5/8 X 6 1/2
D970	5.6	3/4 - 1/2 - 1/3	277	1075	3	3.9-2.2-1.6	Open Vent.	REV	SLV	1/2 X 5 1/2
D730	5.6	3/4 - 1/2	208-230	1075	2	4.8-3.5	Open Vent.	REV	BALL	1/2 X 6
D823	5.6	3/4 - 1/2	460	1075	2	2.1/1.6	Open Vent.	REV	BALL	1/2 X 6
D872	5.6	3/4 - 1/2	230	1075	2	4.3-3.5	Open Vent.	DS	SLV	2 X 1/2 X 6 1/4
D914	5.6	3/4 - 1/2	460	1075	2	2.5/1.6	Open Vent.	REV	BALL	1/2 X 4 1/2
D915	5.6	3/4 - 1/2	460	1075	2	2.5/1.6	Open Vent.	REV	BALL	5/8 X 4 1/2
D1910	5.6	3/4	460	1075	1	2.2	Open Vent.	REV	BALL	1/2 X 6 3/8
D1914	5.6	3/4	460	1050	1	1.7	Totally Encl.	REV	BALL	1/2 X 6
D2753	5.6	3/4	575	1075	1	1.8	Totally Encl.	REV	BALL	1/2 X 6 1/2
D789	5.6	3/4	208-230	1625	1	5.2	Open Vent.	REV	SLV	1/2 X 6
D910	5.6	3/4	460	1075	1	2.2	Open Vent.	REV	BALL	1/2 X 6 3/8
D929	5.6	3/4	208-230	1075	1	5	Open Vent.	REV	SLV	1/2 X 6 1/4
D931	5.6	3/4	208-230	1075	1	4.5	Totally Encl.	REV	BALL	1/2 X 6 1/2
D933	5.6	3/4	208-230	1075	1	5	Totally Encl.	REV	SLV	1/2 X 6 1/2
D940	5.6	3/4	208/230	1075	1	4.4	Open Vent.	REV	BALL	1/2 X 6 1/4
D968	5.6	3/4	460	1075	1	2.5	Open Vent.	REV	SLV	1/2 X 6 1/2
D2871	5.6	1 - 3/4 - 1/2	460	1100	3	3.3-2.3-1.9	Open Vent.	REV	SLV	1/2 X 3 1/2
D2850	5.6	1 - 3/4	208-230/460 60 HZ, 200/380-415 50 HZ	1125/950	1	4.6/2.3	Open Vent.	CW	BALL	1/2 X 3.45
D2851	5.6	1 - 3/4	208-230/460 60 HZ, 200/380-415 50 HZ	1125/950	1	4.6/2.3	Open Vent.	CW	BALL	5/8 X 3.75 Keyed
D825	5.6	1 - 3/4	230	1625	2	6.2 - 5.6	Open Vent.	REV	SLV	1/2 X 3
D2704	5.6	1 - 1/2 - 1/3	208/230	1075	3	5.3/2.8/1.8	Open Vent.	REV	BALL	1/2 X 6 1/4
D2705	5.6	1 - 1/2 - 1/3	115	1075	3	11.6/6.3/3.9	Open Vent.	REV	BALL	1/2 X 6 1/4
D2816	5.6	1 - 1/2 - 1/3	115	1075	3	11.8-6.3-3.9	Open Vent.	REV	BALL	5/8 X 4
D711	5.6	1 - 1/2 - 1/3	208-230	1075	3	5.3-2.8-1.8	Open Vent.	REV	SLV	1/2 X 6
D712	5.6	1 - 1/2 - 1/3	115	1075	3	11.8-6.3-3.9	Open Vent.	REV	SLV	1/2 X 6
D1709	5.6	1	208-230	1075	1	5.5	Open Vent.	REV	BALL	1/2 X 6 1/2

PSC - 5.6" DIAMETER										
MODEL	DIA.	HP	VOLTS	RPM	SPD.	AMPS	ENCLOSURE	ROT.	BRNG.	SHAFT DIM.
D1710	5.6	1	460	1075	1	3	Open Vent.	REV	BALL	1/2 X 6 1/2
D800	5.6	1	208-230	1075	1	7.1-6.4	Open Vent.	CW	BALL	1/2 X 3 3/4
D2714	5.6	.8	200-230/460	1075	1	4.6/2.3	Open Vent.	REV	BALL	1/2 X 5 1/2
D2715	5.6	.8	200-230/460	1075	1	4.6/2.3	Open Vent.	REV	BALL	5/8 X 5 1/2 Keyed
D2711	5.6	.6	200-230/460	1075	1	4 / 2	Open Vent.	REV	BALL	1/2 X 5 1/2
D2712	5.6	.6	200-230/460	1075	1	4 / 2	Open Vent.	REV	BALL	5/8 X 5 1/2 Keyed
D2713	5.6	.6	575	1075	1	1.5	Open Vent.	REV	BALL	1/2 X 5 1/2
D2752	5.6	.6	575	1075	1	1.1	Totally Encl.	REV	BALL	1/2 X 6 1/2
D2710	5.6	.4	200-230/460	1075	1	3.2/1.6	Open Vent.	REV	BALL	1/2 X 5 1/2

3 PHASE - NEMA 48 AND 56										
MODEL	DIA.	HP	VOLTS	RPM	SPD.	FLA	ENCLOSURE	ROT.	BRNG.	SHAFT DIM.
D6608	6.58	1	208-230/460	1140	1	4 / 2	OPEN VENTILATED	REV	BALL	5/8 X 3-3/4
D6610	6.58	1.5	208-230/460	1140	1	5.6 / 2.8	OPEN VENTILATED	REV	BALL	5/8 X 3-3/4
D6622	NEMA 56	1/3	208-230/460	1725	1	1.6 / .8	OPEN DRIP PROOF	REV	BALL	5/8 X 2
D6624	NEMA 56	1/2	208-230/460	1725	1	2 / 1	OPEN DRIP PROOF	REV	BALL	5/8 X 2
D6626	NEMA 56	3/4	208-230/460	1725	1	2.8 / 1.4	OPEN DRIP PROOF	REV	BALL	5/8 X 2
D6628	NEMA 56	1	208-230/460	1725	1	3.4 / 1.7	OPEN DRIP PROOF	REV	BALL	5/8 X 2
D6630	NEMA 56	1.5	208-230/460	1725	1	4.6 / 2.3	OPEN DRIP PROOF	REV	BALL	5/8 X 2
D6631	NEMA 56	2	208-230/460	1725	1	6.2 / 3.1	OPEN DRIP PROOF	REV	BALL	5/8 X 2
D6633	NEMA 56	3	208-230/460	1725	1	8 / 4	OPEN DRIP PROOF	REV	BALL	7/8 X 2-3/8

CAPACITOR START - NEMA 48 AND 56										
MODEL	DIA.	HP	VOLTS	RPM	SPD.	FLA	ENCLOSURE	ROT.	BRNG.	SHAFT DIM.
D6082	NEMA 56	1/3	115/208-230	1725	1	6.2 / 3.1	OPEN DRIP PROOF	REV	BALL	5/8 X 2
D6084	NEMA 56	1/2	115/208-230	1725	1	8.8 / 4.4	OPEN DRIP PROOF	REV	BALL	5/8 X 2
D6066	NEMA 56	3/4	115/208-230	3450	1	9.6 / 4.8	OPEN DRIP PROOF	REV	BALL	5/8 X 2
D6086	NEMA 56	3/4	115/208-230	1725	1	10.8 / 5.4	OPEN DRIP PROOF	REV	BALL	5/8 X 2
D6068	NEMA 56	1	115/208-230	3450	1	12 / 6	OPEN DRIP PROOF	REV	BALL	5/8 X 2
D6088	NEMA 56	1	115/208-230	1725	1	12.8 / 6.4	OPEN DRIP PROOF	REV	BALL	5/8 X 2
D6070	NEMA 56	1.5	115/208-230	3450	1	17.2 / 8.6	OPEN DRIP PROOF	REV	BALL	5/8 X 2
D6090	NEMA 56	1.5	115/208-230	1725	1	14.4 / 7.2	OPEN DRIP PROOF	REV	BALL	5/8 X 2
D6073	NEMA 56	2	115/208-230	3450	1	24 / 12	OPEN DRIP PROOF	REV	BALL	5/8 X 2
D6093	NEMA 56	2	115/208-230	1725	1	20 / 10	OPEN DRIP PROOF	REV	BALL	5/8 X 2

SPLIT PHASE										
MODEL	DIA.	HP	VOLTS	RPM	SPD.	FLA	ENCLOSURE	ROT.	BRNG.	SHAFT DIM.
D6002	NEMA 48	1/4	115/230	1725	1	5.2 / 2.6	OPEN DRIP PROOF	REV	BALL	1/2 X 1-1/2
D6004	NEMA 48	1/3	115/230	1725	1	6.2 / 3.1	OPEN DRIP PROOF	REV	BALL	1/2 X 1-1/2
D6006	NEMA 48	1/2	115/230	1725	1	8.6 / 4.3	OPEN DRIP PROOF	REV	BALL	1/2 X 1-1/2



FASCO MODEL	HP	VOLTS	RPM	SPD.	AMPS	ROT.	BRNG.	SHAFT DIM.	STACK (in.)	FIG.	NOTES
K114	1/500	120	1100	1	0.74	CW	SLV	.1811 X 1.75	.50	A	43
K102	1/500	120	1100	1	0.57	CW	SLV	.1811 X 1.50	.50	A	43, 120
K120	1/260	120	3000	2	.50 - .29	CW	SLV	.2178 X 1.55	.50	B	43, 121
K145	1/250	115	3000	1	.53	CW	SLV	.1814 X 1.00	.50	C	43
K628	1/200	208/230	3000	1	0.25	CW	SLV	.2500 x 1.60	.75	D	44
K614	1/150	120	3000	1	0.59	CW	SLV	.2178 X 1.65	.50	E	43
K673	1/150	120	3000	2	.51 - .27	CW	SLV	.1875 X 1.30	.62	F	44, 121
K670	1/150	120	3000	1	0.61	CCW	SLV	.1875 X 1.30	.62	F	44
K130	1/150	115	3000	1	0.47	CW	SLV	.1811 X 1.00	.62	C	43, 120
K101	1/150	240	1260	1	0.52	CCW	SLV	.2178 X 1.34	1.12	G	43
K672	1/150	240	3000	1	0.29	CCW	SLV	.1875 X 1.30	.62	F	44
K111	1/120	120	3000	1	0.82	CCW	SLV	.2178 X 1.97	.50	H	43
K683	1/100	240	3000	1	0.30	CW	SLV	.1875 X 1.30	1.00	I	43
K100	1/100	120	2750	1	0.73	CW	SLV	.1811 X 1.05	.62	J	43, 120
K611	1/100	120	3000	1	0.63	CCW	SLV	.2500 X 2.45	.75	K	43
K115	1/100	115	3000	1	0.57	CCW	SLV	.2178 X 1.85	.75	L	43
K629	1/85	120	2950	1	0.55	CW	SLV	.2500 x 1.13	1.00	M	44
K109	1/75	115	3000	1	0.77	CCW	SLV	.2178 X 2.37	.75	N	43
K110	1/75	115	3000	1	0.77	CCW	SLV	.2178 X 2.44	.75	N	43, 122

NOTES: 43: Packed 6 per carton ,44: Packed 1 per carton ,120: Use Fan Blades with round hub I.D. ,121: Two Speed Motor ,122: K110 has maximum flat length



FIG. A K114, K102



FIG. B K120



FIG. C K145, K130



FIG. D K628



FIG. E K614



FIG. F K673, K670, K672



FIG. G K101



FIG. H K111



FIG. I K683



FIG. J K100



FIG. K K611



FIG. L K115



FIG. M K629



FIG. N K109, K110

Products on page 19 are NOT SUITABLE for unattended equipment unless indicated by ►. See inside back cover for additional information.

Thermally protected • UL recognized • CSA or ULc certified
NOTE: Rotation is determined by looking at shaft end. Shaft length is measured from motor face.
 ► NEW ITEM! See page 113 for a complete listing of all our new products.



FASCO MODEL	HP	VOLTS	RPM	SPD.	AMPS	ROT.	BRNG.	SHAFT DIM.	STACK (in.)	FIG.	NOTES
K113	1/70	120	3000	1	0.90	CCW	SLV	.2178 X 1.19	.75	H	43
▶ K141	1/70	120	3000	1	0.65	CW	SLV	1.0 x .1814 x 0.75	1.15	I	43, 123
▶ K142	1/70	120	3000	1	0.63	CW	SLV	.1814 X 1.00	1.00	J	43
▶ K143	1/70	220-240	3000	1	0.32	CW	SLV	.1814 X 1.00	1.00	J	43
K612	1/65	120	3000	1	0.73	CW	SLV	.2500 X 2.70	1.00	K	43
K610	1/60	120	3000	2	.75 - .63	CCW	SLV	.2178 X 1.33	1.00	L	43, 121
K112	1/50	120	3000	2	.86 - .44	CW	SLV	.2178 X 1.44	1.00	M	43, 121
K161	1/50	120	3000	1	0.90	CCW	SLV	.2178 X 1.21	1.00	N	43
▶ K144	1/40	120	3000	1	1.00	CCW	SLV	.2178 x 1.50	1.00	O	43
▶ K147	1/30	220-240	3000	1	0.69	CW	SLV	.2499 X 1.00	1.50	P	43
▶ K146	1/20	120	3000	1	2.1	CW	SLV	.2499 X 1.00	1.50	P	43

NOTES: 43: Packed 6 per carton 121: Two Speed Motor 123: Double Shafted

Fan Blades Used With K-Line Motors

FASCO MODEL	ROT.	DESCRIPTION	BORE DIA.	FAN DIA.	FITS SHAFT DIA.	FIG.
K-FAN4032		"D" SHAPED HUB	0.2178	4 5/8		A
K-FAN4031		ROUND BORE HUB	0.1811	4 5/8		A
K-FAN6009	CW	"D" SHAPED HUB	0.2178	6 5/8		B
K-FAN6010	CW	ROUND BORE HUB	0.1811	4		C
K-FAN6012	CW	ROUND BORE HUB	0.1811	3 1/2		D
K-FAN6013	CCW	ROUND BORE HUB	0.1811	5 1/2		E
K-FAN6011	CW	ROUND BORE HUB	0.1811	4		F
K-FAN6046	CCW	ROUND BORE HUB	0.1811	5 1/2		B
K-NUT		PUSH NUT			0.1811	G
K-NUT6002		PUSH NUT			0.2178	G



FIG. A K-FAN4032, K-FAN4031



FIG. B K-FAN6009, K-FAN6046



FIG. C K-FAN6010



FIG. D K-FAN6012



FIG. E K-FAN6013



FIG. F K-FAN6011



FIG. G K-NUT, K-NUT6002



FIG. H K113



FIG. I K141



FIG. J K142, K143



FIG. K K612



FIG. L K610



FIG. M K112



FIG. N K161



FIG. O K144



FIG. P K147, K146



FASCO MODEL	WATT RATING	VOLTS	RPM	SPD.	AMPS	ENCLOSURE	ROT.	BRNG.	"A" DIM.	MATERIAL	THERMAL PROTECTION	THREADED SHAFT	FIG.	NOTES
D550	2	115	1550	1	0.24	Totally Encl.	CWLE	SLV	2.37	Aluminum	Impedence	1/4 - 20	A	45, 124, 143
D551	2	115	1550	1	0.24	Totally Encl.	CCWLE	SLV	2.37	Aluminum	Impedence	1/4 - 20	A	45, 124, 143
D552	2	230	1550	1	0.12	Totally Encl.	CWLE	SLV	2.37	Aluminum	Impedence	1/4 - 20	A	45, 124, 143
D553	2	230	1550	1	0.12	Totally Encl.	CCWLE	SLV	2.37	Aluminum	Impedence	1/4 - 20	A	45, 124, 143
D554	4	115	1550	1	0.34	Totally Encl.	CWLE	SLV	2.42	Aluminum	Impedence	1/4 - 20	A	45, 124, 143
D555	4	115	1550	1	0.34	Totally Encl.	CCWLE	SLV	2.42	Aluminum	Impedence	1/4 - 20	A	45, 124, 143
D556	4	230	1550	1	0.16	Totally Encl.	CWLE	SLV	2.42	Aluminum	Impedence	1/4 - 20	A	45, 124, 143
D557	4	230	1550	1	0.16	Totally Encl.	CCWLE	SLV	2.42	Aluminum	Impedence	1/4 - 20	A	45, 124, 143
D582	5	115	1550	1	0.35	Totally Encl.	CWLE	SLV	2.6	Aluminum	Impedence	1/4 - 20	A	45, 124, 143
D583	5	115	1550	1	0.35	Totally Encl.	CCWLE	SLV	2.6	Aluminum	Impedence	1/4 - 20	A	45, 124, 143
D558	6	115	1550	1	0.42	Totally Encl.	CWLE	SLV	2.61	Aluminum	Impedence	1/4 - 20	A	45, 124, 143
D559	6	115	1550	1	0.42	Totally Encl.	CCWLE	SLV	2.61	Aluminum	Impedence	1/4 - 20	A	45, 124, 143
D560	6	230	1550	1	0.21	Totally Encl.	CWLE	SLV	2.61	Aluminum	Impedence	1/4 - 20	A	45, 124, 143
D561	6	230	1550	1	0.21	Totally Encl.	CCWLE	SLV	2.61	Aluminum	Impedence	1/4 - 20	A	45, 124, 143
D562	9	115	1550	1	0.55	Totally Encl.	CWLE	SLV	2.65	Aluminum	Auto Reset	1/4 - 20	A	45, 124, 143
D563	9	115	1550	1	0.55	Totally Encl.	CCWLE	SLV	2.65	Aluminum	Auto Reset	1/4 - 20	A	45, 124, 143
D564	9	230	1550	1	0.33	Totally Encl.	CWLE	SLV	2.65	Aluminum	Auto Reset	1/4 - 20	A	45, 124, 143
D565	9	230	1550	1	0.33	Totally Encl.	CCWLE	SLV	2.65	Aluminum	Auto Reset	1/4 - 20	A	45, 124, 143
D566	16	115	1550	1	1.1	Totally Encl.	CWLE	SLV	3.34	Iron	Auto Reset	1/4 - 20	B	45, 124, 143
D567	16	115	1550	1	1.1	Totally Encl.	CCWLE	SLV	3.34	Iron	Auto Reset	1/4 - 20	B	45, 124, 145
D568	16	230	1550	1	0.6	Totally Encl.	CWLE	SLV	3.34	Iron	Auto Reset	1/4 - 20	B	45, 124, 143
D569	16	230	1550	1	0.6	Totally Encl.	CCWLE	SLV	3.34	Iron	Auto Reset	1/4 - 20	B	45, 124, 143
D570	25	115	1550	1	1.2	Totally Encl.	CWLE	SLV	3.6	Iron	Auto Reset	1/4 - 20	C	45, 124, 143
D571	25	115	1550	1	1.2	Totally Encl.	CCWLE	SLV	3.6	Iron	Auto Reset	1/4 - 20	C	45, 124, 143
D572	25	230	1550	1	0.66	Totally Encl.	CWLE	SLV	3.6	Iron	Auto Reset	1/4 - 20	C	45, 124, 143
D573	25	230	1550	1	0.66	Totally Encl.	CCWLE	SLV	3.6	Iron	Auto Reset	1/4 - 20	C	45, 124, 143
D574	35	115	1550	1	1.5	Totally Encl.	CWLE	SLV	3.6	Iron	Auto Reset	1/4 - 20	C	45, 124, 143
D575	35	115	1550	1	1.5	Totally Encl.	CCWLE	SLV	3.6	Iron	Auto Reset	1/4 - 20	C	45, 124, 143
D576	35	230	1550	1	0.7	Totally Encl.	CWLE	SLV	3.6	Iron	Auto Reset	1/4 - 20	C	45, 124, 143
D577	35	230	1550	1	0.7	Totally Encl.	CCWLE	SLV	3.6	Iron	Auto Reset	1/4 - 20	C	45, 124, 143
D578	50	115	1550	1	1.8	Open Vent.	CWLE	SLV	4.67	Iron	Auto Reset	3/8 x 1-1/2	D	124, 143
D579	50	115	1550	1	1.8	Open Vent.	CCWLE	SLV	4.67	Iron	Auto Reset	3/8 x 1-1/2	D	124, 143
D580	50	230	1550	1	0.9	Open Vent.	CWLE	SLV	4.67	Iron	Auto Reset	3/8 x 1-1/2	D	124, 143
D581	50	230	1550	1	0.9	Open Vent.	CCWLE	SLV	4.67	Iron	Auto Reset	3/8 x 1-1/2	D	124, 143

NOTES: 45: Speed nut and vibration damper included. 124: All mounting holes drilled and tapped. 143: All motors individually boxed. 145: Interchangeable with GE 21 & 29 Frame motors and other Emerson, Universal and Franklin refrigeration motors



FIG. A D550, D551, D552, D553, D554, D555, D556, D557, D582, D583, D558, D559, D560, D561, D562, D563, D564, D565



FIG. B D566, D567, D568, D569



FIG. C D570, D571, D572, D573, D574, D575, D576, D577



FIG. D D578, D579, D580, D581

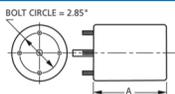

Thermally protected • UL recognized • CSA or ULc certified
NOTE: Rotation is determined by looking at lead end (unit bearing motors this page only).

3.3" Diameter

General Purpose Motors



FASCO MODEL	TYPE	HP	VOLTS	RPM	SPD.	AMPS	ENCLOSURE	ROT.	BRNG.	SHAFT DIM.	"A" DIM.	FIG.	NOTES
D200	SP	1/85	115	3000	1	0.6	Open Vent.	CW	SLV	2 3/8 X 1/4 X 3/4	2	A	85, 165, 166
D201	SP	1/85	115	3000	1	0.6	Open Vent.	CCW	SLV	1/4 X 1 3/8	2 1/4	A	85, 165, 166
D1130	SP	1/200	115	1550	1	0.5	Open Vent.	-	SLV	None	3 1/8	B	112, 85
D229	SP	1/100	115	3000	1	0.55	Open Vent.	CCW	SLV	1/4 X 3 1/2	2 1/2	C	85
D230	SP	1/100	115	3000	1	0.55	Open Vent.	CW	SLV	1/4 X 3 1/2	2 1/2	C	85
D202	SP	1/85	115	3000	1	0.6	Open Vent.	CW	SLV	1/4 X 2 1/4	2 3/8	D	85
D228	SP	1/80	115	3000	1	0.8	Open Vent.	CW	SLV	1/4 X 2	2 1/2	E	85
D203	SP	1/40	115	3000	1	1	Open Vent.	CCW	SLV	1/4 X 2 1/4	2 3/4	D	85
D206	SP	1/30	115	3000	1	1.2	Open Vent.	CW	SLV	1/4 X 2 1/4	2 3/4	D	85
D207	SP	1/30	230	3000	1	0.6	Open Vent.	DS	SLV	2 1/4 X 1/4 X 2 1/4	2 3/4	F	85
D210	SP	1/25	115	3000	1	1.3	Open Vent.	CW	SLV	1/4 X 2 1/4	3 1/4	D	85
D216	SP	1/25	230	3000	1	0.65	Open Vent.	CW	SLV	1/4 X 2 1/4	3 1/4	D	85
D213	SP	1/15	115	3000	1	2.1	Open Vent.	DS	SLV	2 3/4 X 1/4 X 2 3/4	3 7/8	G	85
D211	SP	1/15	230	3000	1	1.1	Open Vent.	DS	SLV	2 1/2 X 1/4 X 2 1/2	3 7/8	G	85
D402	SP	1/60	115	3000	1	0.75	Totally Encl.	CW	SLV	1/4 X 1 3/4	2 3/8	H	85
D403	SP	1/60	115	3000	1	0.75	Totally Encl.	CCW	SLV	1/4 X 2 1/4	2 3/8	H	85
D205	SP	1/40 - 1/70	115	3000	1	1-5	Totally Encl.	DS	SLV	3 X 1/4 X 3	2 7/8	I	85
D608	SP	1/50	230	3000	1	0.6	Open Vent.	CW	SLV	1/4 X 1 5/16	3 3/4	J	167
D209	SP	1/30	115	3000	1	1.1	Open Vent.	DS	SLV	3 1/4 X 1/4 X 3 1/4	3 5/8	K	167
D208	SP	1/30	115	3000	1	1.1	Open Vent.	CW	SLV	1/4 X 3	3 5/8	J	167
D214	SP	1/20	115/230	3000	1	1.7-.8	Totally Encl.	CW	SLV	5/16 X 6 1/2	4 5/8	L	74, 167
D215	SP	1/20	115/230	3000	1	1.7-.8	Totally Encl.	CCW	BALL	5/16 X 6 1/2	4 5/8	L	167
D220	SP	1/20	115/230	3000	1	1.7-.8	Totally Encl.	CW	BALL	5/16 X 6 1/2	4 5/8	L	167
D218	PSC	1/20	115	3000	1	0.8	Totally Encl.	REV	BALL	5/16 X 2 1/4	4 3/8	M	29, 167
D219	PSC	1/8	115	3000	1	1.8	Totally Encl.	REV	BALL	5/16 X 2 1/4	5 1/8	M	29, 167
D404	PSC	1/10	208-230	3000	1	0.8	Open Vent.	REV	BALL	5/16 X 3 1/4	4 1/4	N	29, 85
D405	PSC	1/10	115	3000	1	1.4	Open Vent.	REV	BALL	5/15 X 3 1/4	4 1/4	N	29, 85
D503	PSC	1/10	230	1500	1	0.95	Open Vent.	REV	SLV	5/16 X 3 3/4	4 5/8	O	85

NOTES: 29: 4M 370V capacitor included 74: Popular Ice Machine pump motor 85: Air Over 112: Vibration motor 165: Skeleton Motor
 166: 3.25" Diameter 167: Self-Cooled 168: 10M 440V Capacitor



FIG. A D200, D201



FIG. B D1130



FIG. C D229, D230



FIG. D D202, D203, D206, D210, D216



FIG. E D228



FIG. F D207



FIG. G D213, D211



FIG. H D402, D403



FIG. I D205



FIG. J D608, D208



FIG. K D209



FIG. L D214, D215, D220



FIG. M D218, D219



FIG. N D404, D405



FIG. O D503



FASCO MODEL	TYPE	HP	VOLTS	RPM	SPD.	AMPS	ENCLOSURE	ROT.	BRNG.	SHAFT DIM.	"A" DIM.	FIG.	NOTES
D1127	PSC	1/12	115/230	1550	1	1.1 / 0.6	Open Vent.	REV	SLV	5/16 X 3	3 1/2	A	75
D107	SP	1/160	208-240	600	1	0.5	Open Vent.	CCW	SLV	5/16 X 1	2 5/8	B	85
D129	SP	1/125 - 1/200	115	1500	2	.4 - .3	Open Vent.	DS	SLV	3 1/4 X 1/4 X 3 1/4	2 1/8	C	76, 85
D1119	SP	1/90	240	1500	1	0.34	Open Vent.	CCW	SLV	1/4 X 1 1/2	2 1/4	D	85
D120	SP	1/70	115	1500	1	0.7	Open Vent.	CW	SLV	1/4 X 2 1/4	2 1/8	E	85
D121	SP	1/70	115	1500	1	0.7	Open Vent.	CCW	SLV	1/4 X 2 1/4	2 1/8	E	85
D1134	SP	1/50 - 1/65 - 1/80	115	1500	3	1.1-.8-.6	Open Vent.	CW	SLV	1/4 X 1 3/4	2 1/4	F	85
D609	SP	1/50	115	1500	1	0.9	Open Vent.	CCW	SLV	1/4 X 2 1/4	2 3/16	E	85
D603	SP	1/50	115	1500	1	0.9	Open Vent.	CW	SLV	1/4 x 2 3/8	2 3/16	E	85
D126	SP	1/40	115	1500	1	1.1	Open Vent.	CW	SLV	5/16 X 2 1/4	2 1/2	E	85
D127	SP	1/40	115	1500	1	1	Open Vent.	CCW	SLV	5/16 X 2 1/4	2 1/2	E	85
D128	SP	1/40 - 1/50 - 1/80	115	1500	3	1.3-.9-.6	Open Vent.	DS	SLV	4 X 5/16 X 4	2 1/2	C	85
D190	SP	1/40	230	1500	1	0.6	Open Vent.	CW	SLV	1/4 X 2 1/4	2 1/2	E	85
D106	SP	1/40	115	1500	1	0.9	Open Vent.	CCW	SLV	1/4 X 1 3/4	2 1/8	G	85
D105	SP	1/37	115	1500	1	0.94	Open Vent.	CCW	SLV	1/4 X 1 1/2	2 1/8	G	85
D136	SP	1/30	115	1500	1	1.3	Open Vent.	DS	SLV	2 X 5/16 X 2	3 1/4	C	85
D514	SP	1/30	115	1500	1	1.3	Open Vent.	CW	SLV	5/16 X 2 1/4	2 3/4	H	85
D515	SP	1/30	115	1500	1	1.3	Open Vent.	CCW	SLV	5/16 X 2 1/4	2 5/8	H	85
D532	SP	1/30 - 1/112	115	1500	2	1.4-.8	Open Vent.	CW	SLV	5/16 X 1 1/2	2 3/4	E	85
D181	SP	1/30 - 1/40	115	1500	2	1.3-1	Open Vent.	CCW	SLV	5/16 X 2 1/4	2 5/8	E	85
D332	SP	1/25 - 1/65	115	1500	2	1.5-.8	Open Vent.	CW	SLV	5/16 X 2	3 1/4	I	85
D364	SP	1/25	115	1500	1	1.8	Open Vent.	DS	SLV	1 7/8 X 5/16 X 1 7/8	2 7/8	J	85
D365	SP	1/25	115	1500	1	1.8	Open Vent.	DS	SLV	1 7/8 X 5/16 X 1 7/8	2 7/8	K	77, 85
D184	SP	1/25	115	1500	1	1.2	Open Vent.	CW	SLV	5/16 X 1 7/8	3	L	78, 85
D636	SP	1/25	230	1500	1	0.69	Open Vent.	DS	SLV	2 1/4 X 5/16 X 2 1/4	3 1/4	M	85
D132	SP	1/20	115	1500	1	1.8	Open Vent.	CW	SLV	5/16 X 2 1/4	2 3/4	N	85
D133	SP	1/20	115	1500	1	1.8	Open Vent.	CCW	SLV	5/16 X 2 1/4	2 3/4	N	85
D188	SP	1/20	230	1500	1	0.9	Open Vent.	CW	SLV	5/16 X 2 1/4	2 7/8	N	85

NOTES: 75: Shell Turbo 68, low temp. oil (-40°F) 76: Impedance Protected 77: Has hubs for end rings 78: Closed construction 85: Air Over



FIG. A D1127



FIG. B D107



FIG. C D129, D128, D136



FIG. D D1119



FIG. E D120, D121, D609, D603, D126, D127, D190, D532, D181



FIG. F D1134



FIG. G D106, D105



FIG. H D514, D515



FIG. I D332



FIG. J D364



FIG. K D365



FIG. L D184



FIG. M D636



FIG. N D132, D133, D188

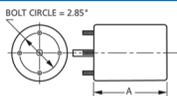

Thermally protected • UL recognized • CSA or ULc certified
 NOTE: Rotation is determined by looking at shaft end. Shaft length is measured from motor face.

NEW ITEM! See page 113 for a complete listing of all our new products.

3.3" Diameter

General Purpose Motors



FASCO MODEL	TYPE	HP	VOLTS	RPM	SPD.	AMPS	ENCLOSURE	ROT.	BRNG.	SHAFT DIM.	"A" DIM.	FIG.	NOTES
D189	SP	1/20	230	1500	1	0.9	Open Vent.	CCW	SLV	5/16 X 2 1/4	2 7/8	A	85
D186	SP	1/20	460	1500	1	0.4	Open Vent.	CW	SLV	5/16 X 2 1/3	2 7/8	A	85
D109	SP	1/15	115	1600	1	2.1	Open Vent.	CW	SLV	5/16 X 3	3	B	85, 131
➤ D1161	SP	1/15 - 1/25	115	1600	2	2.9-2	Open Vent.	CCW	SLV	5/16 X 2	4 1/4	C	85, 131
➤ D540	SP	1/100	115	1500	1	0.6	Totally Encl.	CW	SLV	1/4 X 2 1/4	2 1/8	D	85
➤ D541	SP	1/100	115	1500	1	0.6	Totally Encl.	CCW	SLV	1/4 X 2 1/4	2 1/8	D	85
➤ D1109	SP	1/100	115	1500	1	0.65	Totally Encl.	CCW	SLV	1/4 X 1 1/4	2 1/16	E	85
➤ D1162	SP	1/100	115	1500	1	0.6	Open Vent.	REV	SLV	5/16 X 1	3 1/2	F	85
➤ D122	SP	1/80	115	1500	1	0.6	Totally Encl.	CW	SLV	1/4 X 2 1/4	2 1/8	G	85
➤ D123	SP	1/80	115	1500	1	0.6	Totally Encl.	CCW	SLV	1/4 X 2 1/4	2 1/8	G	85
➤ D182	SP	1/60	115	1500	1	0.6	Totally Encl.	CW	SLV	5/16 X 2 1/4	2 3/4	G	85
➤ D124	SP	1/50	115	1500	1	0.75	Totally Encl.	CW	SLV	1/4 X 2 1/4	2 1/2	G	85
➤ D125	SP	1/50	115	1500	1	0.75	Totally Encl.	CCW	SLV	1/4 X 2 1/4	2 1/2	G	85
➤ D601	SP	1/50	115	1500	1	0.9	Totally Encl.	CCW	SLV	1/4 X 2 1/4	2 3/16	G	85
➤ D602	SP	1/50	115	1500	1	0.9	Totally Encl.	CW	SLV	1/4 X 2 1/4	2 3/16	G	85
➤ D624	SP	1/50	230	1500	1	0.4	Totally Encl.	CW	SLV	1/4 X 2 1/4	2 1/2	G	85
➤ D1139	SP	1/50 - 1/80 - 1/125	115	1500	3	0.88	Open Vent.	CW	SLV	2 1/2 X 5/16 X 1 1/8	2 13/16	H	85
D534	SP	1/35 - 1/100	115	1500	2	1.4-.5	Totally Encl.	CW	SLV	1/4 X 1	2 1/2	I	85
D137	SP	1/30 - 1/65	115	1500	2	1-.7	Totally Encl.	DS	SLV	3 X 5/16 X 3	2 7/8	J	85
D1118	SP	1/30	240	1500	1	0.6	Open Vent.	CW	BALL	5/16 X 3 1/2	2 13/16	K	85
D1164	SP	1/25	115/230	1550	1	1.3-.65	Totally Encl.	CW	SLV	5/16 X 2 1/2	3 1/8	L	85

NOTES: 85: Air Over 131: Motors include shaft bushing



FIG. A D189, D186



FIG. B D109



FIG. C D1161



FIG. D D540, D541



FIG. E D1109



FIG. F D1162



FIG. G D122, D123, D182, D124, D125, D601, D602, D624



FIG. H D1139



FIG. I D534



FIG. J D137



FIG. K D1118



FIG. L D1164



FASCO MODEL	TYPE	HP	VOLTS	RPM	SPD.	AMPS	ENCLOSURE	ROT.	BRNG.	SHAFT DIM.	"A" DIM.	FIG.	NOTES
D429	SP	9 Watts	115	1550	1	0.6	Totally Encl.	CCW	SLV	HUB	2 1/8	A	169, 170, 171, 172
D431	SP	9 Watts	230	1550	1	0.3	Totally Encl.	CCW	SLV	HUB	2 1/8	B	169, 170, 171, 172
D437	SP	16 Watts	115	1550	1	1.1	Totally Encl.	CCW	SLV	HUB	2 7/8	A	169, 170, 171, 172
D477	SP	1/35	208-230	1550	1	0.75	Open Vent.	CCW	SLV	5/16 X 1 5/8	4 1/4	C	173, 174
D471	SP	1/20	208-230	1550	1	1.1	Open Vent.	CCW	SLV	5/16 X 2 1/2	4 1/4	C	173, 174
D417	SP	1/20	208-230	1550	1	1.1	Open Vent.	CCW	BALL	5/16 X 2 1/2	4 1/4	D	173, 174
D470	SP	1/20	208-230	1550	1	0.94	Open Vent.	CW	SLV	5/16 X 2 5/8	4 1/4	C	173, 174
D472	SP	1/20	115	1550	1	1.9	Open Vent.	CW	SLV	5/16 X 2 5/8	4 1/4	C	173, 174
D473	SP	1/20	115	1550	1	2	Open Vent.	CCW	SLV	5/16 X 2 5/8	4 1/4	C	173, 174
D1129	PSC	1/20	115/230	1550	1	0.7/1.35	Totally Encl.	CW	BALL	5/16 x 1 5/8	3 1/8	E	113, 23
D475	SP	1/15	460	1550	1	0.5	Open Vent.	CCW	SLV	5/16 X 2 1/2	4 1/2	F	79, 130, 173, 174
D469	SP	1/12	208-230	1550	1	1.3	Open Vent.	CCW	SLV	5/16 X 2 1/8	4 1/3	G	173, 174

NOTES: 79: See Tecumseh OEM section for cross references 113: PSC version of D1189 (OEM Replacement for Krack Refrigeration. 130: Do not have extended hubs or rubber rings for base mount 169: Mounting bracket designed to match the original motor (four 8-36 drilled and tapped holes) 170: Mounting hardware included 171: Has 22" leads with 1/16" thick insulation 172: Three studs opposite shaft end are 8-32 on a standard 2.84" bolt circle, 120° apart 173: 3.9" diameter 174: Includes 1/2" studs for mounting



FIG. A D429, D437



FIG. B D431



FIG. C D477, D471, D470, D472, D473



FIG. D D417



FIG. E D1129



FIG. F D475



FIG. G D469

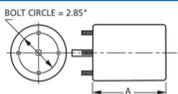

Thermally protected • UL recognized • CSA or ULc certified

NOTE: Rotation is determined by looking at shaft end. Shaft length is measured from motor face.

NEW ITEM! See page 113 for a complete listing of all our new products.

3.3" Diameter

Evaporator Coil and Refrigeration Fan Motors



FASCO MODEL	TYPE	HP	VOLTS	RPM	SPD.	AMPS	ENCLOSURE	ROT.	BRNG.	SHAFT DIM.	"A" DIM.	FIG.	NOTES
BOHN													
D1124	SP	1/20	115	1550	1	2.1	Open Vent.	CW	SLV	5/16 X 3	3	D	75
D1126	SP	1/15	208-230	1550	1	1.1	Open Vent.	CW	SLV	5/16 X 3	3 1/2	D	75
D1125	PSC	1/12	208-230	1550	1	0.5	Open Vent.	CCW	SLV	5/16 X 2 5/8	3 3/4	E	29
KEEPRITE													
D1120	SP	1/20	115	1550	1	2.1	Open Vent.	CW	SLV	5/16 X 2 1/2	3 1/2	C	
D1121	SP	1/20	208-230	1550	1	1	Open Vent.	CW	SLV	5/16 X 2 1/2	3 1/2	C	
D1243	PSC	1/20	115	1550	1	0.8	Open Vent.	CCW	SLV	5/16 X 2 3/4	4 1/8	I	29
D1245	PSC	1/20	208-230	1550	1	0.3	Open Vent.	CCW	SLV	5/16 X 2 3/4	4	I	29
KRAMER/TRENTON													
D1152	SP	1/20	115	1500	1	1.7	Open Vent.	CW	SLV	5/16 X 2 3/8	2 7/8	A	
D1154	SP	1/20	230	1550	1	1	Open Vent.	CW	SLV	5/16 X 2 3/8	3 1/8	A	
LARKIN COIL													
D1101	SP	1/20	115	1500	1	1.9	Open Vent.	CCW	SLV	5/16 X 2 1/4	2 3/4	A	75
D1103	SP	1/20	208-230	1500	1	1.15	Open Vent.	CCW	SLV	5/16 X 2 1/4	3	A	75, 201
MCQUAY													
D1144	PSC	1/25 - 1/35 - 1/65	115	1200	3	1.1-.9-.6	Open Vent.	CW	SLV	3/8 X 5 3/8	4 3/4	G	1
D1142	SP	1/15	115/230	1500	1	1.7-.9	Open Vent.	CW	SLV	5/16 X 2 1/2	3 1/2	F	175
SINGER													
▶ D1164	SP	1/25	115/230	1550	1	1.3-.65	Totally Encl.	CW	SLV	5/16 X 2 1/2	3 1/8	H	
WITT													
D1102	PSC	1/20	115/230	1550	1	.75-.4	Open Vent.	CW	SLV	5/16 X 2-5/8	3 1/2	B	

NOTES: 1: 4M 370V capacitor 29: 4M 370V capacitor included 75: Shell Turbo 68, low temp. oil (-40°F) 175: Bolt circle = 3.15"



FIG. A D1152, D1154, D1101, D1103



FIG. B D1102



FIG. C D1120, D1121



FIG. D D1124, D1126



FIG. E D1125



FIG. F D1142



FIG. G D1144



FIG. H D1164



FIG. I D1243, D1245



FASCO MODEL	TYPE	HP	VOLTS	RPM	SPD.	AMPS	ENCLOSURE	ROT.	BRNG.	SHAFT DIM.	"A" DIM.	FIG.	NOTES
D134	SP	1/25	115	1500	1	1.6	Totally Encl.	CW	SLV	5/16 X 2 1/4	4 1/4	A	
D1138	SP	1/50 - 1/80 - 1/140	115	1500	3	.9-.6-.5	Open Vent.	CW	SLV	5/16 X 2 1/2	4	B	
D135	SP	1/25	115	1500	1	1.6	Totally Encl.	CCW	SLV	5/16 X 2 1/4	4 1/4	A	
D192	SP	1/25	230	1500	1	0.9	Totally Encl.	CW	SLV	5/16 X 2 1/4	4 1/4	C	
D226	SP	1/20	115	1500	1	1.6	Totally Encl.	CW	BALL	5/16 X 2 1/4	4 1/4	C	
D227	SP	1/20	115	1500	1	1.7	Totally Encl.	CCW	BALL	5/16 X 2 1/4	4 1/4	A	
D334	SP	1/15	230	1500	1	1.4	Totally Encl.	CW	BALL	5/16 X 3	4 3/4	C	
D234	SP	1/15	115	1500	1	2.2	Totally Encl.	CW	SLV	5/16 X 2 1/4	4 3/4	C	
D235	SP	1/12	115	1580	1	2.2	Totally Encl.	CCW	SLV	5/16 X 2 1/4	4 3/4	C	
D138	SP	1/25	115	1500	1	1.6	Totally Encl.	CW	SLV	5/16 X 2 5/8	4 1/2	D	
D238	SP	1/15	115	1500	1	2.3	Totally Encl.	CW	SLV	5/16 X 2 5/8	4 1/2	D	80
D167	SP	1/70	115	1500	1	0.7	Open Vent.	CW	SLV	1/4 X 3	2 7/8	E	
D169	SP	1/70	115	1500	1	0.7	Open Vent.	CCW	SLV	1/4 X 3	3	E	
D130	SP	1/40	115	1500	1	1	Open Vent.	CW	SLV	5/16 X 4 1/8	3 1/3	E	
D131	SP	1/40	115	1500	1	1	Open Vent.	CCW	SLV	5/16 X 2 1/4	3 1/3	E	
D330	SP	1/40	230	1500	1	0.5	Open Vent.	CW	SLV	5/16 X 2 1/4	3 7/8	E	
D1173	SP	1/30	115	1500	1	1.2	Open Vent.	CW	BALL	5/16 X 2 1/2	3 7/8	F	
D504	PSC	1/8	115/230	1500	1	1.6-.8	Open Vent.	REV	SLV	5/16 X 3 1/2	5 1/2	G	81, 173

NOTES: 80: With conduit box 81: PSC motor requiring a 10 MFD 370V cap 173: 3.9" diameter



FIG. A D134, D135, D227



FIG. B D1138



FIG. C D192, D226, D334, D234, D235



FIG. D D138, D238



FIG. E D167, D169, D130, D131, D330



FIG. F D1173



FIG. G D504

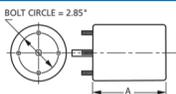

Thermally protected • UL recognized • CSA or ULc certified
NOTE: Rotation is determined by looking at shaft end. Shaft length is measured from motor face.

▶ NEW ITEM! See page 113 for a complete listing of all our new products.

3.3" Diameter



FASCO MODEL	TYPE	HP	VOLTS	RPM	SPD.	AMPS	ENCLOSURE	ROT.	BRNG.	SHAFT DIM.	"A" DIM.	FIG.	NOTES
D1111	SP	1/18 - 1/30	115	1330	2	2.4-1.6	Open Vent.	CCW	SLV	3 1/8 X 5/16 X 2 3/8	3 1/2	A	82
D366	SP	1/14 - 1/25	115	1550	2	2.5-1.5	Open Vent.	DS	SLV	6 3/8 X 5/16 X 6 3/8	3 1/4	B	
D367	SP	1/12 - 1/20 - 1/30	115	1550	3	3-2.1-1.7	Open Vent.	DS	SLV	5 3/4 X 5/16 X 5 3/4	3 5/8	B	
D325	SP	1/10 - 1/30	115	1550	2	2.5-2.3	Open Vent.	CCW	SLV	1 3/4 X 5/16 X 2 3/8	3 1/2	C	82
D1176	PSC	1/15 - 1/25	115	1550	2	.9-.8	Totally Encl.	DS	SLV	4 7/8 X 3/8 X 4 7/8	4	D	1
D323	PSC	1/15 - 1/20 - 1/35	115	1550	3	1-.8-.6	Totally Encl.	DS	SLV	2 3/4 X 5/16 X 2 3/4	3 3/4	E	83, 9
D326	PSC	1/10 - 1/20 - 1/25	115	1550	3	2.2-1.8-1.5	Open Vent.	DS	BALL	5 1/2 X 5/16 X 3	4 1/8	F	84

NOTES: 1: 4M 370V capacitor 9: 3M 370V capacitor 82: Rotation determined by viewing lug end 83: Totally enclosed, Sears-Whirlpool 5000-8000 BTU units.
84: 4M 370V capacitor (similar to GE WJ94X306)



FIG. A D1111



FIG. B D366, D367



FIG. C D325



FIG. D D1176



FIG. E D323



FIG. F D326



FASCO MODEL	TYPE	HP	VOLTS	RPM	SPD.	AMPS	ENCLOSURE	ROT.	BRNG.	SHAFT DIM.	"A" DIM.	FIG.	NOTES
D418	SP	1/50	115	1550	1	1.1	Open Vent.	CW	BALL	1/4 X 3	5 1/2	A	33, 41
D415	SP	1/40	115	1550	1	1.1	Open Vent.	CCW	BALL	1/4 X 3	5 1/2	A	33, 41
D1191	SP	1/40	460	3200	1	0.37	Open Vent.	CCW	BALL	1/4 X 2 1/2	5 3/4	B	33, 41, 131
D1192	SP	1/40	115	3000	1	0.7	Open Vent.	CCW	SLV	5/16 X 1 1/2	5 1/3	C	41
D1196	SP	1/33	115	3200	1	1.5	Open Vent.	CCW	SLV	5/16 X 2 1/3	3 1/4	D	33
D1198	SP	1/30	115	3200	1	1.5	Open Vent.	CCW	SLV	5/16 X 2 1/4	3 1/8	E	33
D1194	SP	1/25	115	3200	1	1.7	Open Vent.	CW	BALL	5/16 X 1 1/3	5 1/2	F	41
D1193	SP	1/22	115	3000	1	1.2	Open Vent.	CCW	SLV	5/16 X 2 1/3	2 7/8	G	33
D1188	SP	1/15	208-230/460	3000	1	1.1-.6	Open Vent.	CW	BALL	5/16 X 2	6 5/8	H	33, 41
D408	SP	1/150	115	3000	1	0.5	Open Vent.	CW	SLV	1/4 X 1 1/2		I	86, 131, 41
D1167	SP	1/40	208-230	3000	1	0.55	Open Vent.	CCW	SLV	5/16 X 1		J	41
D455	SP	1/30	115/230	3000	1	1.3-7	Open Vent.	CCW	BALL	1/4 X 3 7/8		K	131, 41
D222	SP	1/25	115	1500	1	1.6	Totally Encl.	DS	SLV	2 1/4 X 5/16 X 2 1/4	2 7/8	L	85
D520	SP	1/20 - 1/50 - 1/100	115	1500	3	2-1-.6	Totally Encl.	CW	SLV	1/4 X 2 1/4	3 1/8	M	85, 49, 176
D1186	PSC	1/16	460	3450	1	0.3	Open Vent.	CCW	BALL	5/16 X 3 1/3	4 3/4	N	29
D1184	PSC	1/16	460	3450	1	0.3	Open Vent.	CCW	BALL	5/16 X 3 1/3	4 3/4	N	10, 29
D410	PSC	1/10	115	3000	1	1.5	Open Vent.	REV	BALL	1/4 X 3 3/4	7 1/8	O	17, 131, 33, 41
D412	PSC	1/9	230	3000	1	0.7	Open Vent.	REV	BALL	1/4 X 3 3/4	6 5/8	O	29, 131, 33, 41

NOTES: 10: Has hall effect sensor 17: 7.5M 370V Cap installed 29: 4M 370V capacitor included 33: Stainless steel shaft 41: Includes centrifugal switch 49: Mechanically Reversible 85: Air Over 86: Drilled & Tapped Holes (No. 8-32NC) in face of case at shaft end for mounting in various Coleman mobile home furnace applications, also has mounting studs. 131: Motors include shaft bushing 176: Endshield on D520 is easily removed, allowing rotor and shaft to be rotated, thereby reversing motor rotation.



FIG. A D418, D415



FIG. B D1191



FIG. C D1192



FIG. D D1196



FIG. E D1198



FIG. F D1194



FIG. G D1193



FIG. H D1188



FIG. I D408



FIG. J D1167



FIG. K D455



FIG. L D222



FIG. M D520



FIG. N D1186, D1184



FIG. O D410, D412

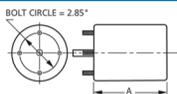

Thermally protected • UL recognized • CSA or ULc certified
NOTE: Rotation is determined by looking at shaft end. Shaft length is measured from motor face.

NEW ITEM! See page 113 for a complete listing of all our new products.

3.3" Diameter

Flue Exhaust and Draft Booster Blower Motors



FASCO MODEL	TYPE	HP	VOLTS	RPM	SPD.	AMPS	ENCLOSURE	ROT.	BRNG.	SHAFT DIM.	FIG.	NOTES
D454	SP	1/30	115	3000	1	1.5	Open Vent.	CW	SLV	1/4 X 1 1/2	A	177, 131, 41
D456	SP	1/15	115/230	3000	1	2-1	Totally Encl.	CW	BALL	1/4 X 2 3/4	B	33, 131, 41
D458	SP	1/15	208-230	3000	1	1	Open Vent.	CW	BALL	1/4 X 2 3/4	B	33, 131, 41
D457	SP	1/15	115/230	3000	1	2-1	Open Vent.	CCW	BALL	1/4 X 2 3/4	B	33, 131, 41
D1174	SP	1/15	460	3000	1	0.6	Open Vent.	CW	BALL	1/4 X 2 1/2	B	41
D1171	SP	1/15	460	3000	1	0.6	Open Vent.	CCW	BALL	1/4 X 2 1/2	B	131, 41
D1169	SP	1/10	208-230	3000	1	1.5	Open Vent.	CCW	SLV	5/16 X 1	C	41
D1179	SP	1/30	115	3000	1	1.5	Open Vent.	CW	SLV	5/16 X 2	D	33
D1190	SP	1/30	115	3000	1	1.6	Open Vent.	CW	SLV	5/16 X 1 3/4	E	33
D1180	SP	1/20	115	3300	1	1.9	Open Vent.	CW	SLV	5/16 X 2 1/8	D	33

NOTES: 33: Stainless steel shaft , 41: Includes centrifugal switch , 131: Motors include shaft bushing , 177: Used in Economite, "E-20", LS1/Miller and Mid Continent gas units.



FIG. A D454



FIG. B D456, D458, D457, D1174, D1171



FIG. C D1169



FIG. D D1179, D1180



FIG. E D1190

FASCO MODEL	TYPE	HP	VOLTS	RPM	SPD.	AMPS	ENCLOSURE	ROT.	BRNG.	SHAFT DIM.	"A" DIM.	FIG.	NOTES
D1061	SP	1/20 - 1/30 - 1/60	115	1500	3	2-1.7-1.4	Open Vent.	CCW	SLV	1/2 X 2 3/4	4 1/8	A	
D170	SP	1/20	115	1500	1	1.7	Open Vent.	CW	SLV	5/16 X 2 1/4	2 3/4	B	
D116	SP	1/15	115	1500	1	2.4	Open Vent.	CW	SLV	3/8 X 2 3/8	3	B	
D118	SP	1/15 - 1/30	115	1500	2	2.4-1.4	Open Vent.	CW	SLV	3/8 X 2 3/8	3	B	
D1170	SP	1/15	115	1500	1	2.1	Open Vent.	CW	BALL	3/8 X 2 1/2	4 3/4	C	
D377	SP	1/12	115	1500	1	3.1	Open Vent.	CCW	SLV	3/8 X 2	2 3/4	B	68
D310	SP	1/12	115	1500	1	4	Open Vent.	CW	SLV	3/8 X 2	2 3/4	B	69
D119	SP	1/11 - 1/25 - 1/70	115	1500	3	2.9-1.5-1	Open Vent.	CCW	BALL	1/2 X 2 5/8	3 3/4	D	
D174	SP	1/10	115	1500	1	3.5	Open Vent.	CW	SLV	3/8 X 2 7/8	3 3/8	E	
D674	SP	1/10 - 1/15	230	1500	2	2-1.3	Open Vent.	CW	SLV	3/8 X 2 1/2	3 5/8	B	
D1039	SP	1/10	115	1610	1	3.1	Open Vent.	CCW	SLV	1/2 X 2 3/8	4 1/2	F	
D374	SP	1/8 - 1/20	115	1500	2	4-2.5	Open Vent.	CW	SLV	3/8 X 2 1/2	3 5/8	B	
D312	SP	1/15	115	1500	1	2.7	Open Vent.	CW	SLV	1/2 X 5	4 1/4	G	178, 179
D112	SP	1/10	115	1500	1	3.6	Open Vent.	CW	SLV	3/8 X 2 5/8	4 1/2	G	
D435	SP	1/10	230	1500	1	1.7	Open Vent.	CCW	SLV	3/8 X 2 5/8	4 1/2	G	

NOTES: 68: Used in Jenn Air units. P/N 7108-2101 69: Used in Leslie Locke ventilators original P/N 7108-5056
 178: External oil retainer to accommodate resilient rings and cradle base, drilled and tapped holes in case for mounting in Coleman applications. (2 holes each end on case OD). 179: Self cooled for mechanical duty



FIG. A D1061



FIG. B D170, D116, D118, D377, D310, D674, D374



FIG. C D1170



FIG. D D119



FIG. E D174



FIG. F D1039



FIG. G D312, D112, D435

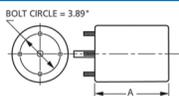

Thermally protected • UL recognized • CSA or ULc certified
 NOTE: Rotation is determined by looking at shaft end. Shaft length is measured from motor face.

NEW ITEM! See page 113 for a complete listing of all our new products.

4.4" Diameter

Fan Coil Air-Conditioning and Heating Unit Motors



FASCO MODEL	TYPE	HP	VOLTS	RPM	SPD.	AMPS	ENCLOSURE	ROT.	BRNG.	SHAFT DIM.	"A" DIM.	FIG.
D333	SP	1/25	115	1550	1	1.4	Open Vent.	DS	SLV	7 1/4 X 3/8 X 7 1/4	2 7/8	A
D335	SP	1/20 - 1/30 - 1/40 - 1/60	115	1550	4	2.1-1.4-1.2-1.1	Open Vent.	DS	SLV	8 X 1/2 X 8	3 1/4	A
D117	SP	1/15 - 1/25 - 1/30 - 1/40	115	1550	4	2.4-1.4-1.1-.9	Open Vent.	CCW	SLV	1/2 X 7 1/2	3	B
D329	SP	1/15	115	1550	1	2.5	Open Vent.	DS	SLV	7 1/2 X 3/8 X 7 1/2	3 3/8	C
D236	SP	1/10 - 1/15 - 1/25	115	1550	3	3.5-2.4-1.8	Open Vent.	DS	SLV	7 1/2 X 1/2 X 7 1/2	3 3/8	D
D336	SP	1/10 - 1/15 - 1/25	115	1550	3	3.5-2.4-1.8	Open Vent.	DS	SLV	7 1/2 X 3/8 X 7 1/2	3 1/2	D
D635	SP	1/10 - 1/20 - 1/35	230	1550	3	1.8-1.3-1	Open Vent.	DS	SLV	10 X 1/2 X 10	3 3/8	D
D337	SP	1/8 - 1/10 - 1/12 - 1/15	115	1550	4	4.1-2.7-2.3-1.9	Open Vent.	DS	SLV	7 1/2 X 1/2 X 7 1/2	3 5/8	D
D339	SP	1/8 - 1/12	230	1550	2	2-1.4	Open Vent.	DS	SLV	6 1/2 X 1/2 X 6 1/2	4 1/8	D
D338	SP	1/6 - 1/10 - 1/12 - 1/15	115	1550	4	5.4-3.2-2.5-2.1	Open Vent.	DS	SLV	7 1/4 X 1/2 X 7 1/4	4 1/8	D
D1006	SP	1/4	115	1600	1	7.2	Open Vent.	CW	SLV	1/2 X 2 3/4	4 1/8	E
➤ D113	SP	1/12	115/230	1550	1	2.5-1.3	Totally Encl.	CCW	SLV	3/8 X 3	4 1/8	F
➤ D114	SP	1/12	115/230	1550	1	2.5-1.3	Totally Encl.	CW	SLV	3/8 X 3	4 1/8	F
➤ D115	SP	1/12	115/230	1550	1	2.5-1.3	Totally Encl.	CCW	SLV	1/2 X 2	4 1/8	F



FIG. A **D333, D335**



FIG. B **D117**



FIG. C **D329**



FIG. D **D236, D336, D635, D337, D339, D338**



FIG. E **D1006**



FIG. F **D113, D114, D115**



FASCO MODEL	TYPE	HP	VOLTS	RPM	SPD.	AMPS	ENCLOSURE	ROT.	BRNG.	SHAFT DIM.	"A" DIM.	CROSS REF.	FIG.	NOTES
D484	SP	1/20	115/208-230	1550	1	2.2-1.1	Open Vent.	CW	SLV	3/8 X 3 1/8	4	GE 2341,2342	A	49, 126, 148, 154, 180
D482	SP	1/15	115/208-230	1550	1	3.2-1.6	Open Vent.	CW	SLV	3/8 X 3 1/8	4	GE 2241,2242	A	49, 126, 148, 154, 180
D480	SP	1/10	115/208-230	1550	1	4.5-2.2	Open Vent.	CW	SLV	3/8 X 3 1/8	4 5/8	GE 2141,2142	A	49, 126, 148, 154, 180
D485	SP	1/20	115/208-230	1550	1	2.2-1.1	Open Vent.	CCW	SLV	3/8 X 3 1/8	4	GE 2331, 2332	A	49, 126, 148, 154, 180
D483	SP	1/15	115/208-230	1550	1	3.2-1.6	Open Vent.	CCW	SLV	3/8 X 3 1/8	4	GE 2231,2232	A	49, 126, 148, 154, 180
D481	SP	1/10	115/208-230	1550	1	4.5-2.2	Open Vent.	CCW	SLV	3/8 X 3 1/8	4 5/8	GE 2131, 2132	A	49, 126, 148, 154, 180

NOTES: 49: Mechanically Reversible 126: 3/8" shaft diameter with adapter to convert to 1/2" diameter 148: Weld nuts on 3.5" B.C. for stud mount
 154: Extended hubs with rubber rings for base mount 180: Can be operated on 50Hz with air-over applications



FIG. A D484, D482, D480, D485, D483, D481

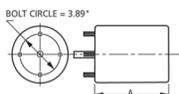

Thermally protected • UL recognized • CSA or ULc certified
NOTE: Rotation is determined by looking at shaft end. Shaft length is measured from motor face.

▶ NEW ITEM! See page 113 for a complete listing of all our new products.

5.0" Diameter

Condenser Fan & Heat Pump - Cap Can Construction



FASCO MODEL	TYPE	HP	VOLTS	RPM	SPD.	AMPS	ENCLOSURE	ROT.	BRNG.	"C" DIM.	FIG.	NOTES
G2243	PSC	1/10	208-230	1100	1	0.74	Totally Encl.	CWLE	BALL	6.1	A	111, 142
G2248	PSC	1/8	208-230	1075	1	0.86	Totally Encl.	CWLE	BALL	6.1	A	111, 142
G2249	PSC	1/8	208-230	1075	1	0.75	Totally Encl.	CCWLE	BALL	6.1	A	111, 142
G2247	PSC	1/6	208-230	1100	1	1.3	Totally Encl.	CCWLE	BALL	6.7	A	111, 142
G2246	PSC	1/5	208-230	1080	1	1.6	Totally Encl.	CWLE	BALL	6.51	A	111, 142
G2244	PSC	1/4	208-230	1075	1	1.7	Totally Encl.	CWLE	BALL	6.7	A	111, 142
G2245	PSC	1/4	208-230	1075	1	1.7	Totally Encl.	CCWLE	BALL	6.7	A	111, 142

NOTES: 111: Application: Designed for use in residential outdoor condenser fan and heat pump units (primarily up to 3.5 ton)
 142: Vertical shaft down application.

FASCO MODEL	TYPE	HP	VOLTS	RPM	SPD.	AMPS	ENCLOSURE	ROT.	BRNG.	SHAFT DIM.	"A" DIM.	CROSS REF.	FIG.	NOTES
D494	SP	1/20	115/208-230	1050	1	3-1.6	Open Vent.	CW	SLV	3/8 X 3 1/8	4	GE 2321, 2322	B	49, 126, 167, 148, 154
D492	SP	1/15	115/208-230	1050	1	3.4-1.7	Open Vent.	CW	SLV	3/8 X 3 1/8	4 5/8	GE 2223	B	49, 126, 167, 148, 154
D490	SP	1/10	115/208-230	1050	1	5-2.5	Open Vent.	CW	SLV	3/8 X 3 1/8	4 5/8	GE 2121, 2122	B	49, 126, 167, 148, 154
D495	SP	1/20	115/208-230	1050	1	3-1.6	Open Vent.	CCW	SLV	3/8 X 3 1/8	4	GE 2311, 2312	B	49, 126, 167, 148, 154
D493	SP	1/15	115/208-230	1050	1	3.4-1.7	Open Vent.	CCW	SLV	3/8 X 3 1/8	4 5/8	GE 2213	B	49, 126, 167, 148, 154
D491	SP	1/10	115/208-230	1050	1	5-2.5	Open Vent.	CCW	SLV	3/8 X 3 1/8	4 5/8	GE 2113	B	49, 126, 167, 148, 154
D486	PSC	1/10	115/208-230	1550	1	2.5-1.3	Open Vent.	REV	SLV	3/8 X 3 1/8	4 1/8		C	50, 167
D487	PSC	1/10	115/208-230	1550	1	2.7-1.4	Open Vent.	REV	BALL	3/8 X 3 1/8	4 7/8		D	50, 167
D497	PSC	1/10	115/208-230	1050	1	2-1	Open Vent.	REV	BALL	3/8 X 3 1/8	4 7/8		D	50, 167
D488	PSC	1/20	115/208-230	1550	1	1.2-.6	Open Vent.	REV	SLV	3/8 X 3 1/3	4 9/16	GE 2341, 2342 2331, 2332	E	50, 127, 85
D489	PSC	1/15	115/208-230	1550	1	1.2-.6	Open Vent.	REV	SLV	3/8 X 3 1/3	4 13/16	GE 2241, 2342 2231, 2232	E	50, 127, 85
D474	PSC	1/10	115/208-230	1550	1	1.9-1	Open Vent.	REV	SLV	3/8 X 3 1/3	4 13/16	GE 2141, 2142 2131, 2132	E	50, 127, 85

NOTES: 49: Mechanically Reversible 50: 3M 370V Capacitor Included 85: Air Over 126: 3/8" shaft diameter with adapter to convert to 1/2" diameter
 127: Front endshield drilled and tapped with four 10-32 threads on 3.5" bolt circle 148: Weld nuts on 3.5" B.C. for stud mount 154: Extended hubs with rubber rings for base mount 167: Self-Cooled



FIG. A G2243, G2248, G2249, G2247, G2246, G2244, G2245



FIG. B D494, D492, D490, D495, D493, D491



FIG. C D486



FIG. D D487, D497



FIG. E D488, D489, D474



FASCO MODEL	TYPE	HP	VOLTS	RPM	SPD.	AMPS	ENCLOSURE	ROT.	BRNG.	SHAFT DIM.	"A" DIM.	FIG.	NOTES
D249	SP	1/50 - 1/80 - 1/160	115	1050	3	1.1-.6-.4	Open Vent.	DS	SLV	7 5/8 X 3/8 X 7 5/8	2 5/8	A	147
D255	SP	1/25 - 1/50 - 1/80	115	1050	3	1.5-1-.6	Open Vent.	DS	SLV	7 1/2 X 1/2 X 7 1/2	3 1/4	A	147
D250	SP	1/25 - 1/50 - 1/80	115	1050	3	1.5-1-.6	Open Vent.	DS	SLV	8 X 3/8 X 8	3 1/4	A	147
D655	SP	1/25 - 1/40 - 1/70	230	1050	3	.7-.5-.3	Open Vent.	DS	SLV	10 X 1/2 X 10	3 1/4	A	147
D252	SP	1/20 - 1/40 - 1/70	115	1050	3	1.6-.8-.5	Open Vent.	DS	SLV	7 1/2 X 3/8 X 7 1/2	2 5/8	A	147
D253	SP	1/20 - 1/40 - 1/50	115	1050	3	2.2-1.4-.8	Open Vent.	DS	SLV	7 1/2 X 1/2 X 7 1/2	2 5/8	A	
D254	SP	1/15 - 1/30 - 1/50	115	1050	3	2.1-1.3-.8	Open Vent.	DS	SLV	8 X 3/8 X 8	3 1/4	A	147
D251	SP	1/15 - 1/35 - 1/50	208-230	1050	3	1.2-.5-.4	Open Vent.	DS	SLV	9 1/4 X 1/2 X 8 1/2	2 5/8	B	
D257	SP	1/15 - 1/20 - 1/25	277	1050	3	1.1-.7-.6	Totally Encl.	DS	SLV	9 X 1/2 X 9	3 1/4	C	147
D389	SP	1/15 - 1/20 - 1/30 - 1/50	115	1050	4	2.4-1.6-1.1-.8	Open Vent.	DS	SLV	10 1/4 X 1/2 X 10 1/4	3 1/8	A	147
D256	SP	1/10 - 1/20 - 1/30	115	1050	3	3.4-1.7-1	Open Vent.	DS	SLV	8 X 1/2 X 8	3 7/8	A	147
D293	SP	1/10 - 1/30 - 1/40 - 1/45 - 1/50	115	1050	5	3.6-1.6-1.2-.8-.6	Open Vent.	DS	SLV	10 3/4 X 3/8 X 10 3/4	3 1/4	B	
D289	SP	1/10 - 1/30 - 1/40 - 1/45 - 1/50	115	1050	5	3.6-1.6-1.2-.8-.6	Open Vent.	DS	SLV	10 3/4 X 1/2 X 10 3/4	3 1/4	B	
D224	SP	1/6 - 1/8 - 1/12	230	1050	3	3.2-2.3-1.8	Open Vent.	DS	SLV	10 X 1/2 X 10		A	147
D290	PSC	1/10 - 1/15 - 1/25 - 1/40	115	1050	4	2.2-1.4-1-.7	Open Vent.	REV	SLV	1/2 X 8 1/2	3 1/4	D	29, 128,
D291	PSC	1/10 - 1/15 - 1/25 - 1/40	115	1050	4	2.2-1.4-1-.7	Open Vent.	DS	SLV	10 3/4 X 1/2 X 10 3/4	3 1/4	E	
D294	PSC	1/10 - 1/20 - 1/25 - 1/35 - 1/50	115	1050	5	1.3-1-.7-.6-.5	Open Vent.	DS	SLV	10 3/4 X 3/8 X 10 3/4	3 1/4	E	
D292	PSC	1/10 - 1/15 - 1/25 - 1/35	208-230	1050	4	1-.7-.4-.3	Open Vent.	DS	SLV	10 3/4 X 1/2 X 10 3/4	3 1/4	E	
D277	PSC	1/10 - 1/12 - 1/20	277	1050	3	.7-.5-.4	Open Vent.	DS	SLV	8 1/2 X 1/2 X 8 1/2	3 7/8	F	29, 147
D1005	PSC	1/10	460	1075	2	0.5	Open Vent.	DS	SLV	9 5/8 X 1/2 X 9 5/8	3 1/3	B	
D354	PSC	1/6 - 1/10 - 1/20	115	1050	3	2.8-1.8-1	Open Vent.	DS	SLV	8 1/2 X 1/2 X 8 1/2	3 7/8	F	53, 147
D245	PSC	1/3 - 1/5	230	1050	2	2.9-1.7	Open Vent.	DS	SLV	8 X 1/2 X 8	4 1/2	G	53, 147
D221	PSC	1/6 - 1/8 - 1/10 - 1/12	115	1550	4	3.2-1.7-1.3-1	Open Vent.	DS	SLV	8 X 1/2 X 8	3 5/8	G	
D382	PSC	1/25 - 1/40 - 1/50	115	1550	3	.6-.4-.3	Open Vent.	DS	SLV	6 7/8 X 1/2 X 6 7/8	3	G	54, 147
D1050	PSC	1/8	230	1550	1	1.1	Open Vent.	CW	SLV	1/2 X 3	3 1/4	H	147, 199
D347	PSC	1/8 - 1/10 - 1/15 - 1/20	115	1550	4	2.3-1.6-1.2-.7	Open Vent.	DS	SLV	10 1/2 X 1/2 X 10 1/2	3	I	29
D247	PSC	1/6 - 1/8 - 1/12	230	1550	3	1-.7-.5	Open Vent.	DS	SLV	8 X 1/2 X 8	3 7/8	A	29, 147
D258	PSC	1/5 - 1/10	208-230	1550	2	2.8-1.3	Open Vent.	DS	SLV	8 X 1/2 X 8	3 3/8	F	54, 147
D1025	PSC	1/3	208-230	1625	1	2.3	Open Vent.	DS	SLV	7 1/8 X 1/2 X 7 1/4	4 1/8	A	54

NOTES: 29: 4M 370V capacitor included 53: 4M 370 capacitor included 54: 5M 370V capacitor included 128: Electrically Reversible
 147: COMES WITH 2 1/2" O.D. RUBBER MOUNTING RINGS 199: Original motor is SP, D1050 is PSC to provide greater motor efficiency and permit closing shaft end of motor to prevent moisture from entering motor



FIG. A D249, D255, D250, D655, D252, D253, D254, D389, D256, D224, D247, D1025



FIG. B D251, D293, D289, D1005



FIG. C D257



FIG. D D290



FIG. E D291, D294, D292



FIG. F D277, D354, D258



FIG. G D245, D221, D382



FIG. H D1050



FIG. I D347

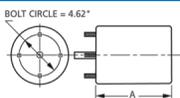

Thermally protected • UL recognized • CSA or ULc certified
 NOTE: Rotation is determined by looking at shaft end. Shaft length is measured from motor face.

NEW ITEM! See page 113 for a complete listing of all our new products.



FASCO MODEL	TYPE	HP	VOLTS	RPM	SPD.	AMPS	ENCLOSURE	ROT.	BRNG.	SHAFT DIM.	"A" DIM.	FIG.	NOTES
D154	SP	1/10	115	1050	1	5	Open Vent.	CW	SLV	3/8 X 2 3/4	4 5/8	A	182
D177	SP	1/10 - 1/20	115	1050	2	3.9-1.7	Open Vent.	CCW	SLV	3/8 X 3 5/8	2 5/8	B	
D176	SP	1/10 - 1/20	115	1050	2	3.9-1.7	Open Vent.	CW	SLV	3/8 X 3	2 5/8	C	
D160	SP	1/10 - 1/12 - 1/15	115	1050	3	3.4-2.8-2.4	Open Vent.	CW	SLV	3/8 X 3 7/8	3 7/8	D	
D656	SP	1/8	230	1050	1	2.1	Open Vent.	CW	SLV	1/2 X 3 7/8	3 7/8	D	
D1046	SP	1/8	115	1070	1	5.1	Open Vent.	CW	SLV	1/2 X 2 1/4	3	A	
D178	SP	1/8 - 1/11	115	1050	2	4.5-3.4	Open Vent.	CW	SLV	1/2 X 4	3 1/4	A	183
D314	SP	1/8 - 1/15	230	1050	2	2.3-1.5	Open Vent.	CW	SLV	1/2 X 5	4 3/8	E	183, 163
D180	SP	1/8 - 1/11	115	1050	2	4.5-3.4	Open Vent.	CW	SLV	1/2 X 4	3 1/4	F	
D316	SP	1/8 - 1/10	230	1050	2	2.1-1.8	Open Vent.	CW	SLV	1/2 X 3 1/2	3 7/8	G	
D356	SP	1/8 - 1/10 - 1/12	115	1050	3	4.7-3.7-3.2	Open Vent.	CW	SLV	1/2 X 3 1/2	3 1/8	H	
D156	SP	1/6	115	1050	1	6.6	Open Vent.	CW	SLV	1/2 X 3 7/8	3 7/8	A	
D166	SP	1/6 - 1/9	115	1050	2	7.2-3.8	Open Vent.	CW	SLV	1/2 X 3 1/2	3 7/8	A	
D164	SP	1/6 - 1/8 - 1/10 - 1/2	115	1050	4	6.5-4.8-4.3-3.7	Open Vent.	CW	SLV	1/2 X 4 1/2	3 7/8	A	
D318	SP	1/6 - 1/8	230	1050	2	3.1-2.2	Open Vent.	CW	SLV	1/2 X 3 1/2	4	F	
D158	SP	1/5 - 1/6 - 1/7	115	1050	3	6.7-5.3-4.7	Open Vent.	CW	SLV	1/2 X 4 1/8	3 7/8	A	
D658	SP	1/5 - 1/6 - 1/7 - 1/8	208-230	1050	4	4-3.4-3.1-2.4	Open Vent.	CW	SLV	1/2 X 5 1/4	3 7/8	A	
D150	PSC	1/4 - 1/5 - 1/6	115	1050	3	4.1-3.2-2.5	Open Vent.	REV	SLV	1/2 X 6	4 1/8	I	
D151	PSC	1/4 - 1/5 - 1/6	230	1050	3	1.7-1.2-1	Open Vent.	REV	SLV	1/2 X 6	4 1/8	I	
D152	PSC	1/4 - 1/5 - 1/6 - 1/8	277	1050	4	1.6-1.1-.9-.7	Open Vent.	REV	SLV	1/2 X 6	4 1/8	I	
D264	PSC	1/8	230	1550	1	1.1	Open Vent.	REV	SLV	1/2 X 5	3 1/3	J	57
D262	PSC	1/5	230	925	1	2.3	Open Vent.	REV	SLV	1/2 X 4	3 7/8	F	57

NOTES: 57: Luxaire/Whisperaire 163: Internal cooling fan 182: Has internal fan & 3.5" BC mounting holes for GE 21/29 Frame replacement. 183: Drilled and tapped holes in case for Coleman mounting



FIG. A D154, D1046, D178, D156, D166, D164, D158, D658



FIG. B D177



FIG. C D176



FIG. D D160, D656



FIG. E D314



FIG. F D180, D318, D262



FIG. G D316



FIG. H D356



FIG. I D150, D151, D152



FIG. J D264



FASCO MODEL	TYPE	HP	VOLTS	RPM	SPD.	AMPS	ENCLOSURE	ROT.	BRNG.	SHAFT DIM.	"A" DIM.	FIG.	NOTES
D340	SP	1/40	115	1050	1	1.1	Totally Encl.	CW	SLV	3/8 X 2 5/8	2 5/8	A	
D143	SP	1/30 - 1/40	115	1050	2	1.5-1	Open Vent.	CCW	SLV	1/2 X 1 5/8	2 1/4	B	
D1038	SP	1/25	115	1050	1	1.4	Open Vent.	CW	SLV	1/2 X 2 1/2	4	C	185
D1036	SP	1/20	115	1045	1	1.95	Open Vent.	CW	SLV	3/8 X 2 1/8	2 3/8	D	
D342	SP	1/15	115	1050	1	2.3	Open Vent.	CW	SLV	3/8 X 2 1/2	2 9/16	D	
D140	SP	1/15	115	1050	1	2.7	Open Vent.	CW	SLV	3/8 X 2 3/8	2 5/8	E	
D142	SP	1/15 - 1/25	115	1050	2	2.6-1.6	Open Vent.	CW	SLV	3/8 X 2 3/8	2 1/4	F	185
D1054	SP	1/12 - 1/20 - 1/25	115	1050	3	3.1-2.1-1.5	Open Vent.	CW	SLV	1/2 X 2 1/2	2 5/8	G	
D148	SP	1/10	115	1050	1	3.6	Open Vent.	CW	SLV	3/8 X 3 1/2	2 5/8	H	185
D144	SP	1/10	115	1050	1	3.6	Open Vent.	CW	SLV	1/2 X 4 1/2	2 5/8	E	185
D1066	SP	1/10	115	1050	1	3.6	Open Vent.	CW	BALL	1/2 X 2 3/4	3 7/8	I	185
D1028	SP	1/8	115	1050	1	3.3	Open Vent.	CW	BALL	1/2 X 2 1/2	3 1/2	J	185
D240	SP	1/6	115	1050	1	6.2	Open Vent.	CW	SLV	1/2 X 3 1/2	4	K	
S156	SP	1/6	115	1050	1	6.6	Open Vent.	CW	SLV	1/2 X 3 7/8	3 1/2	L	
D242	SP	1/20	115	1050	1	2	Totally Encl.	CW	SLV	3/8 X 3	3 1/8	A	64, 186
D261	PSC	1/8 - 1/15	115	1075	2	2.3-1.1	Totally Encl.	REV	SLV	1/2 X 3	3 5/8	M	29, 186
D260	PSC	1/6	115	1075	1	2.9	Totally Encl.	CW	SLV	1/2 X 3	3 7/8	M	29, 129, 186

NOTES: 29: 4M 370V capacitor included 64: Sterling Radiator Co. 129: Repl. For ITT REZNOR 185: Rooftop Ventilator 186: Unit Heater



FIG. A D340, D242



FIG. B D143



FIG. C D1038



FIG. D D1036, D342



FIG. E D140, D144



FIG. F D142



FIG. G D1054



FIG. H D148



FIG. I D1066



FIG. J D1028



FIG. K D240



FIG. L S156



FIG. M D261, D260

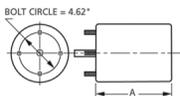

Thermally protected • UL recognized • CSA or ULc certified
NOTE: Rotation is determined by looking at shaft end. Shaft length is measured from motor face.

NEW ITEM! See page 113 for a complete listing of all our new products.

5.6" Diameter

Condenser Fan Motors



FASCO MODEL	TYPE	HP	VOLTS	RPM	SPD.	AMPS	ENCLOSURE	ROT.	BRNG.	SHAFT DIM.	"A" DIM.	FIG.	NOTES
SHAFT DOWN OR HORIZONTAL													
S719	PSC	1/5 - 1/8	208-230	1075	2	1.3-.8	Open Vent.	REV	SLV	1/2 X 6 1/2	3 3/4	A	36, 128, 189, 97
D743	PSC	1/5	208-230	1075	1	1.2	Open Vent.	REV	SLV	1/2 X 6	3 1/2	A	36, 128, 189, 97
D742	PSC	1/4	208-230	1075	1	2.1	Open Vent.	REV	SLV	1/2 X 6	4	A	36, 128, 189, 97
D944	PSC	1/3	208-230	1075	1	2.9	Open Vent.	REV	SLV	1/2 X 6	4 1/4	A	97, 128, 189
D744	PSC	1/3 - 1/4	208-230	1075	2	3.2-2.4	Open Vent.	REV	SLV	1/2 X 6 1/2	4 3/4	A	97, 128, 189
D740	PSC	1/2	208-230	1075	1	4.5	Open Vent.	REV	SLV	1/2 X 6 1/2	5	A	97, 128, 189
SHAFT UP OR HORIZONTAL													
D720	PSC	1/5	208-230	1075	1	1.5	Open Vent.	REV	SLV	1/2 X 6	3 1/4	B	128, 187, 188, 189, 97
D719	PSC	1/5 - 1/8	208-230	1075	2	1.3-.8	Open Vent.	REV	SLV	1/2 X 6 1/2	3 3/4	B	128, 187, 188, 189, 97
D7749	PSC	1/4	208-230	1075	1	1.7	Open Vent.	REV	BALL	1/2 X 6 1/2	3 3/4	C	128, 187, 188, 189, 97
D749	PSC	1/4	208-230	1075	1	1.8	Open Vent.	REV	SLV	1/2 X 6 1/2	3 3/4	D	128, 187, 188, 189, 97
D939	PSC	1/4	208-230	1075	1	2.1	Open Vent.	REV	BALL	1/2 X 6	4	D	128, 187, 188, 189, 97
D940	PSC	3/4	208/230	1075	1	4.4	Open Vent.	REV	BALL	1/2 X 6 1/4	5 1/3	E	24, 128, 187, 188, 189
D739	PSC	1/4 - 1/6	208-230	1075	2	2-1.3	Open Vent.	REV	BALL	1/2 X 6	4 1/4	F	128, 187, 188, 189, 97
D7748	PSC	1/3	208-230	1075	1	2.9	Open Vent.	REV	BALL	1/2 X 6 1/2	4 1/4	H	128, 187, 188, 189, 97
D748	PSC	1/3	208-230	1075	1	2.9	Open Vent.	REV	SLV	1/2 X 6 1/2	4 1/4	G	128, 187, 188, 189, 97
D737	PSC	1/3 - 1/4	208-230	1075	2	3.5-1.9	Open Vent.	REV	BALL	1/2 X 6	4 1/2	F	128, 187, 188, 189, 97
D935	PSC	1/2	208-230	1075	1	4.1	Open Vent.	REV	BALL	1/2 X 6 1/2	5	D	12, 128, 187, 188, 189
D7745	PSC	1/2	208-230	1075	1	3.7	Open Vent.	REV	BALL	1/2 X 6 1/2	4 3/4	I	12, 128, 187, 188, 189
D745	PSC	1/2	208-230	1075	1	4.1	Open Vent.	REV	SLV	1/2 X 6 1/2	4 3/4	D	12, 128, 187, 188, 189
D735	PSC	1/2 - 1/3	208-230	1075	2	4.4-2.7	Open Vent.	REV	BALL	1/2 X 6	5 1/4	F	13, 128, 187, 188, 189
D929	PSC	3/4	208-230	1075	1	5	Open Vent.	REV	SLV	1/2 X 6 1/4	5 1/4	D	12, 128, 187, 188, 189
D930	PSC	3/4 - 1/3	208-230	1075	2	4.4-2.1	Open Vent.	REV	BALL	1/2 X 6 1/4	5 1/4	E	24, 128, 187, 188, 189
D951	PSC	3/4 - 1/3	208-230	1075	2	5-2.2	Open Vent.	REV	BALL	5/8 X 4 1/2 Keyed	5 1/4	E	24, 128, 187, 188, 189
D1709	PSC	1	208-230	1075	1	5.5	Open Vent.	REV	BALL	1/2 X 6 1/2	5 13/16	J	24, 132, 128, 187, 188

NOTES: 12: 10M 370V Capacitor 13: 7.5M 370V Capacitor 24: 15M 370V Capacitor 36: Has 4 drilled and tapped holes in shell 97: All angle mount bearings 128: Electrically Reversible 132: Open vented on opposite shaft end 187: Includes shaft water slinger 188: 60° ambient temperature rating 189: Closed end shield shaft end



FIG. A S719, D743, D742, D944, D744, D740



FIG. B D720, D719



FIG. C D7749



FIG. D D749, D939, D935, D745, D929



FIG. E D940, D930, D951



FIG. F D739, D737, D735



FIG. G D748



FIG. H D7748



FIG. I D7745



FIG. J D1709



FASCO MODEL	TYPE	HP	VOLTS	RPM	SPD.	AMPS	ENCLOSURE	ROT.	BRNG.	SHAFT DIM.	"A" DIM.	FIG.	NOTES
825 RPM MOTORS													
D799	PSC	1/8	208-230	825	1	0.9	Totally Encl.	REV	SLV	1/2 X 6	4	A	36, 128, 188, 190
D793	PSC	1/6	208-230	825	1	1	Totally Encl.	REV	BALL	1/2 X 6	4	B	190, 128, 188
D5488	PSC	1/6-1/8	208-230	825	1	1	Totally Encl.	REV	BALL	1/2 X 6 5/8	4	C	36, 128, 188, 190
D798	PSC	1/6	208-230	825	1	1.3	Totally Encl.	REV	SLV	1/2 X 6	4 1/3	A	36, 128, 188, 190
D794	PSC	1/5	208-230	825	1	1.3	Totally Encl.	REV	SLV	1/2 X 6	4 1/3	A	36, 128, 188, 190
D934	PSC	1/4	208-230	825	1	1.9	Totally Encl.	REV	SLV	1/2 X 6	4 1/3	C	36, 128, 188, 190
D792	PSC	1/4	208-230	825	1	1.8	Open Vent.	REV	BALL	1/2 X 6	4 1/4	C	36, 92, 128, 188, 190
D797	PSC	1/4	208-230	825	1	1.8	Open Vent.	REV	SLV	1/2 X 6	4 1/4	D	36, 133, 128, 188, 190
D936	PSC	1/3	208-230	825	1	2	Totally Encl.	REV	SLV	1/2 X 6	5	C	91, 139, 128, 188
D796	PSC	1/3	208-230	825	1	2.6	Open Vent.	REV	SLV	1/2 X 6	5	D	36, 133, 128, 188, 190
D5489	PSC	1/3-1/4	208-230	825	1	1.8	Totally Encl.	REV	BALL	1/2 X 6 5/8	4 3/4	C	36, 139, 128, 188
D791	PSC	1/3	208-230	825	1	2.6	Open Vent.	REV	BALL	1/2 X 6	5	C	36, 92, 128, 188, 190
D795	PSC	1/3	115	825	1	6.1	Open Vent.	REV	BALL	1/2 X 6	5 3/4	C	92, 139, 128, 188
D938	PSC	1/2	208-230	825	1	3.4	Open Vent.	REV	SLV	1/2 X 6	5 1/2	E	128, 188, 98
D790	PSC	1/2	208-230	825	1	3.5	Open Vent.	REV	BALL	1/2 X 6	5	C	128, 188, 98
D713	PSC	1/2	208-230	825	1	3.0	Totally Encl.	REV	SLV	1/2 X 6	5 1/3	F	128, 190
DESERT LINE													
D1745	PSC	1/2	208-230	1075	1	4.1	Open Vent.	REV	SLV	1/2 X 6 1/2	5	G	128, 190
D1748	PSC	1/3	208-230	1075	1	2.9	Open Vent.	REV	SLV	1/2 X 6 1/2	4	G	128, 190
D1749	PSC	1/4	208-230	1075	1	2.1	Open Vent.	REV	SLV	1/2 X 6	4	G	128, 190
TOTALLY ENCLOSED MOTORS													
D919	PSC	1/8	208-230	1075	1	0.9	Totally Encl.	REV	SLV	1/2 X 6 1/2	3 3/4	H	36, 97, 128, 188
D905	PSC	1/6 - 1/8	208-230	1075	2	1.2-9	Totally Encl.	REV	SLV	1/2 X 6 1/2	3 3/4	I	188, 97, 128
D917	PSC	1/6	208-230	1075	1	1	Totally Encl.	REV	SLV	1/2 X 6 1/2	3 3/4	H	36, 97, 128, 188
D906	PSC	1/5	208-230	1075	1	1.2	Totally Encl.	REV	SLV	1/2 X 6 1/2	4	H	36, 97, 128, 188
D904	PSC	1/4 - 1/5	208-230	1075	2	1.8-1	Totally Encl.	REV	SLV	1/2 X 6 1/2	4 1/4	I	188, 97, 128
D1702	PSC	1/4 - 1/8	208-230	1075	2	1.7-.8	Totally Encl.	REV	BALL	1/2 X 6	4	I	188, 97, 128
D922	PSC	1/4	208-230	1075	1	1.8	Totally Encl.	REV	SLV	1/2 X 6 1/2	4 1/3	H	93, 97, 128, 188
D7909	PSC	1/4	208-230	1075	1	1.8	Totally Encl.	REV	BALL	1/2 X 6 1/2	4	J	36, 97, 128, 188
D909	PSC	1/4	208-230	1075	1	1.8	Totally Encl.	REV	SLV	1/2 X 6 1/2	4	H	36, 97, 128, 188
D903	PSC	1/3 - 1/4	208-230	1075	2	2.7-1.3	Totally Encl.	REV	SLV	1/2 X 6 1/2	4 3/4	I	13, 97, 128, 188
D1701	PSC	1/3 - 1/4	208-230	1075	2	2.2-1.3	Totally Encl.	REV	BALL	1/2 X 5 1/2	5	I	13, 97, 128, 188
D925	PSC	1/3	208-230	1075	1	2.7	Totally Encl.	REV	SLV	1/2 X 6 1/2	4 3/4	H	13, 93, 128, 97, 188
D7908	PSC	1/3	208-230	1075	1	2.6	Totally Encl.	REV	BALL	1/2 X 6 1/2	4 1/2	J	13, 36, 128, 190, 188
D908	PSC	1/3	208-230	1075	1	2.4	Totally Encl.	REV	SLV	1/2 X 6 1/2	4 1/2	H	13, 36, 128, 190, 188

NOTES: 13: 7.5M 370V Capacitor 36: Has 4 drilled and tapped holes in shell 91: 7.5MFD 370VAC capacitor 92: Shaft up or horizontal applications
 93: Motor has increased stack for higher ambient temperatures 97: All angle mount bearings 128: Electrically Reversible 133: Shaft down or horizontal applications
 188: 60° ambient temperature rating 190: All angle mount bearings. Use rain shield when necessary.



FIG. A D799, D798, D794



FIG. B D793



FIG. C D5488, D934, D792, D936, D5489, D791, D795, D790



FIG. D D797, D796



FIG. E D938



FIG. F D713



FIG. G D1745, D1748, D1749



FIG. H D919, D917, D906, D922, D909, D925, D908



FIG. I D905, D904, D1702, D903, D1701



FIG. J D7909, D7908

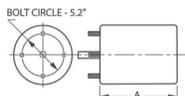

Thermally protected • UL recognized • CSA or ULc certified
 NOTE: Rotation is determined by looking at shaft end. Shaft length is measured from motor face.

NEW ITEM! See page 113 for a complete listing of all our new products.

5.6" Diameter

Condenser Fan Motors



FASCO MODEL	TYPE	HP	VOLTS	RPM	SPD.	AMPS	ENCLOSURE	ROT.	BRNG.	SHAFT DIM.	"A" DIM.	FIG.	NOTES
TOTALLY ENCLOSED MOTRS cont.													
D1700	PSC	1/2 - 1/3	208-230	1075	2	3.7-1.9	Totally Encl.	REV	BALL	1/2 X 5 1/2	5	A	13, 128, 188, 97
D932	PSC	1/2	208-230	1075	1	3.9	Totally Encl.	REV	SLV	1/2 X 6 1/2	5 5/8	B	12, 93, 128, 188, 97
D7907	PSC	1/2	208-230	1075	1	3.7	Totally Encl.	REV	BALL	1/2 X 6 1/2	5	C	12, 128, 188, 97
D907	PSC	1/2	208-230	1075	1	3.7	Totally Encl.	REV	SLV	1/2 X 6 1/2	4 3/4	B	12, 128, 188, 97
D933	PSC	3/4	208-230	1075	1	5	Totally Encl.	REV	SLV	1/2 X 6 1/2	5 3/4	B	24, 93, 128, 188, 97
D931	PSC	3/4	208-230	1075	1	4.5	Totally Encl.	REV	BALL	1/2 X 6 1/2	5 1/4	B	24, 128, 188, 97

NOTES: 12: 10M 370V Capacitor 13: 7.5M 370V Capacitor 24: 15M 370V Capacitor 93: Motor has increased stack for higher ambient temperatures
 97: All angle mount bearings 128: Electrically Reversible 188: 60° ambient temperature rating



FIG. A **D1700**



FIG. B **D932, D907, D933, D931**



FIG. C **D7907**



FASCO MODEL	TYPE	HP	VOLTS	COOLING	HEATING	SPEED CONN.	CAP	CAP. @ 208V	CAP. @ 230V	RPM	AMPS	ENCLOSURE	ROT.	BRNG.	SHAFT DIM.	"A" DIM.	FIG.	NOTES
CONDENSED FAN MOTORS																		
D2826	PSC	1/3	208-230			HIGH			7.5 MFD	825	1.9	Totally Encl.	REV	BALL	1/2 X 5	5 1/4	C	36
	PSC	1/4				HIGH			7.5 MFD	825	1.5	Totally Encl.	REV	BALL	1/2 X 5	5 1/4	C	36
	PSC	1/5				LOW		10 MFD		825	1.2	Totally Encl.	REV	BALL	1/2 X 5	5 1/4	C	36
	PSC	1/6				LOW		10 MFD		825	1.0	Totally Encl.	REV	BALL	1/2 X 5	5 1/4	C	36
D837	PSC	1/3	208-230			HIGH			5 MFD	1075	2.6	Totally Encl.	REV	SLV	1/2 X 3 3/4	4 1/2	C	36
	PSC	1/4				HIGH			5 MFD	1075	2.5	Totally Encl.	REV	SLV	1/2 X 3 3/4	4 1/2	C	36
	PSC	1/5				LOW		7.5 MFD		1075	2.0	Totally Encl.	REV	SLV	1/2 X 3 3/4	4 1/2	C	36
	PSC	1/6				LOW		7.5 MFD		1075	1.8	Totally Encl.	REV	SLV	1/2 X 3 3/4	4 1/2	C	36
D2827	PSC	1/3	208-230			HIGH			10 MFD	1075	3.0	Totally Encl.	REV	BALL	1/2 X 5	5 1/4	C	36
	PSC	1/4				HIGH			10 MFD	1075	2.2	Totally Encl.	REV	BALL	1/2 X 5	5 1/4	C	36
	PSC	1/5				LOW		12.5 MFD		1075	1.6	Totally Encl.	REV	BALL	1/2 X 5	5 1/4	C	36
	PSC	1/6				LOW		12.5 MFD		1075	1.3	Totally Encl.	REV	BALL	1/2 X 5	5 1/4	C	36
DIRECT DRIVE FAN & BLOWER MOTORS																		
D2835	PSC	1/2	115	HIGH	MED-LOW		10 MFD			1075	7.3	Open Vent.	REV	SLV	1/2 X 3 3/4	4 3/4	A	36
	PSC	1/3		HIGH	MED-LOW		5 MFD			1075	6.9	Open Vent.	REV	SLV	1/2 X 3 3/4	4 3/4	A	36
	PSC	1/4		MED-HI	LOW		5 MFD			1075	5.5	Open Vent.	REV	SLV	1/2 X 3 3/4	4 3/4	A	36
	PSC	1/5		MED-LOW	LOW		5 MFD			1075	3.6	Open Vent.	REV	SLV	1/2 X 3 3/4	4 3/4	A	36
	PSC	1/6		LOW	LOW		5 MFD			1075	2.8	Open Vent.	REV	SLV	1/2 X 3 3/4	4 3/4	A	36
D833	PSC	1/2	208-230	HIGH	MED-LOW		10 MFD			1075	3.6	Open Vent.	REV	BALL	1/2 X 4 1/2	4 3/4	A	36
	PSC	1/3		HIGH	MED-LOW		5 MFD			1075	3.5	Open Vent.	REV	BALL	1/2 X 4 1/2	4 3/4	A	36
	PSC	1/4		MED-HI	LOW		5 MFD			1075	2.8	Open Vent.	REV	BALL	1/2 X 4 1/2	4 3/4	A	36
	PSC	1/5		MED-LOW	LOW		5 MFD			1075	1.9	Open Vent.	REV	BALL	1/2 X 4 1/2	4 3/4	A	36
	PSC	1/6		LOW	LOW		5 MFD			1075	1.3	Open Vent.	REV	BALL	1/2 X 4 1/2	4 3/4	A	36
D2832	PSC	3/4	115	HIGH	MED-LOW		20 MFD			1075	8.1	Open Vent.	REV	SLV	1/2 X 5	5 3/4	B	36
	PSC	1/2		HIGH	LOW		10 MFD			1075	6.6	Open Vent.	REV	SLV	1/2 X 5	5 3/4	B	36
	PSC	1/3		MED-HI	LOW		10 MFD			1075	4.6	Open Vent.	REV	SLV	1/2 X 5	5 3/4	B	36
	PSC	1/4		MED-LOW	LOW		10 MFD			1075	3.8	Open Vent.	REV	SLV	1/2 X 5	5 3/4	B	36
	PSC	1/5		LOW	LOW		10 MFD			1075	3.1	Open Vent.	REV	SLV	1/2 X 5	5 3/4	B	36
D2833	PSC	3/4	208-230	HIGH	MED-LOW		20 MFD			1075	3.8	Open Vent.	REV	SLV	1/2 X 5 1/2	5 3/4	B	36
	PSC	1/2		HIGH	LOW		10 MFD			1075	3.7	Open Vent.	REV	SLV	1/2 X 5 1/2	5 3/4	B	36
	PSC	1/3		MED-HI	LOW		10 MFD			1075	2.5	Open Vent.	REV	SLV	1/2 X 5 1/2	5 3/4	B	36
	PSC	1/4		MED-LOW	LOW		10 MFD			1075	1.8	Open Vent.	REV	SLV	1/2 X 5 1/2	5 3/4	B	36
	PSC	1/5		LOW	LOW		10 MFD			1075	1.7	Open Vent.	REV	SLV	1/2 X 5 1/2	5 3/4	B	36

NOTES: 36: Has 4 drilled and tapped holes in shell



FIG. A D2835, D833



FIG. B D2832, D2833



FIG. C D2826, D837, D2827

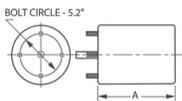

Thermally protected • UL recognized • CSA or ULc certified

NOTE: Rotation is determined by looking at shaft end. Shaft length is measured from motor face.

NEW ITEM! See page 113 for a complete listing of all our new products.

5.6" Diameter

Condenser Fan Motors



FASCO MODEL	TYPE	HP	VOLTS	RPM	AMPS	ENCLOSURE	ROT.	BRING.	SHAFT DIM.	"A" DIM.	FIG.	NOTES
208/230 VAC MOTORS												
D5458	PSC	1/5,1/4,1/3	208-230	1075	2.0	Totally Encl.	REV	SLV	1/2 X 6 3/4	4 1/4	A	13, 128, 36
D5459	PSC	1/8,1/6	208-230	1075	1.0	Totally Encl.	REV	SLV	1/2 X 6 3/4	3 3/4	A	128, 36
230/460 VAC MOTORS WITH INTERNAL COOLING FAN												
S2846	PSC	1/2	230/460	1075	3.9/2	Open Vent.	REV	BALL	1/2 X 5 3/8	6 1/2	B	14, 188, 97, 95, 128
S2848	PSC	3/4	230/460	1075	4.7/2.4	Open Vent.	REV	BALL	1/2 X 6	7 3/4	C	15, 128, 188, 97, 95
460 VAC MOTORS												
D980	PSC	1/4	460	1075	1	Totally Encl.	REV	BALL	1/2 X 6	4 1/3	D	128, 188, 97, 128
D913	PSC	1/4	460	1075	1.1	Open Vent.	REV	BALL	1/2 X 6 3/8	4 1/4	E	95, 128, 97, 188
D982	PSC	1/3	460	1075	1.2	Totally Encl.	REV	BALL	1/2 X 6 1/2	4 3/4	F	128, 188, 97
D966	PSC	1/3	460	1075	1.5	Open Vent.	REV	SLV	1/2 X 6 1/2	4 1/2	G	128, 188, 97
D912	PSC	1/3	460	1075	1.1	Open Vent.	REV	BALL	1/2 X 6 3/8	4 1/4	E	13, 95, 97, 188, 128
D821	PSC	1/3 - 1/4	460	1075	1.2/1	Open Vent.	REV	BALL	1/2 X 6	4 3/4	H	13, 97, 188, 128
D967	PSC	1/2	460	1075	1.6	Open Vent.	REV	SLV	1/2 X 6	5	I	13, 128, 97, 188
D1911	PSC	1/2	460	1075	1.8	Open Vent.	REV	BALL	1/2 X 6 3/8	5	J	24, 96, 97, 188, 128
D911	PSC	1/2	460	1075	1.8	Open Vent.	REV	BALL	1/2 X 6 3/8	5	E	24, 95, 97, 188, 128
D819	PSC	1/2	208-230/460	1075	4-2	Open Vent.	REV	BALL	1/2 X 3	7	K	13, 134, 97, 188, 128
D968	PSC	3/4	460	1075	2.5	Open Vent.	REV	SLV	1/2 X 6 1/2	5 1/2	G	13, 128, 97, 188
D1910	PSC	3/4	460	1075	2.2	Open Vent.	REV	BALL	1/2 X 6 3/8	5 1/2	J	96, 24, 97, 188, 128
D910	PSC	3/4	460	1075	2.2	Open Vent.	REV	BALL	1/2 X 6 3/8	5 1/2	E	24, 95, 97, 188, 128
D915	PSC	3/4 - 1/2	460	1075	2.5/1.6	Open Vent.	REV	BALL	5/8 X 4 1/2	5 1/2	L	24, 135, 151, 188, 128
D914	PSC	3/4 - 1/2	460	1075	2.5/1.6	Open Vent.	REV	BALL	1/2 X 4 1/2	5 1/2	L	24, 135, 128, 188
D823	PSC	3/4 - 1/2	460	1075	2.1/1.6	Open Vent.	REV	BALL	1/2 X 6	5 1/2	H	24, 128, 188
D1710	PSC	1	460	1075	3	Open Vent.	REV	BALL	1/2 X 6 1/2	6	M	24, 128, 188
D2852	PSC	1 - 3/4	208-230/460	1125/950	4.6/2.3	Open Vent.	REV	BALL	5/8 X 3 3/4 Keyed	6 1/2	N	
D802	PSC	1/2	460	1050	0.9	Totally Encl.	REV	BALL	1/2 X 3 1/3	5 1/2	O	97, 12, 128, 188



NOTES: 12: 10M 370V Capacitor 13: 7.5M 370V Capacitor 14: 7.5M 440V Capacitor 15: 20M 370V Capacitor 24: 15M 370V Capacitor 36: Has 4 drilled and tapped holes in shell 95: Comes with unmounted conduit box. 96: Has maximum ventilation for high ambient temperatures 97: All angle mount bearings 128: Electrically Reversible 134: Does not have removable conduit boxes 135: Special wiring configuration. Cannot be used with SPDT switching. 151: Has keyed shaft 188: 60° ambient temperature rating



FIG. A D5458, D5459



FIG. B S2846



FIG. C S2848



FIG. D D980



FIG. E D913, D912, D911, D910



FIG. F D982



FIG. G D966, D968



FIG. H D821, D823



FIG. I D967



FIG. J D1911, D1910



FIG. K D819



FIG. L D915, D914



FIG. M D1710



FIG. N D2852



FIG. O D802





FASCO MODEL	TYPE	HP	VOLTS	RPM	SPD.	AMPS	ENCLOSURE	ROT.	BRING.	SHAFT DIM.	"A" DIM.	FIG.	NOTES
200-575 VAC FAN SHELTERED MOTORS													
D2710	PSC	.4	200-230/460	1075	1	3.2/1.6	Open Vent.	REV	BALL	1/2 X 5 1/2	5 1/4	A	128, 188, 11
D2711	PSC	.6	200-230/460	1075	1	4 / 2	Open Vent.	REV	BALL	1/2 X 5 1/2	6 3/4	B	128, 188, 13
D2712	PSC	.6	200-230/460	1075	1	4 / 2	Open Vent.	REV	BALL	5/8 X 5 1/2 Keyed	6 3/4	C	128, 188, 13
D2713	PSC	.6	575	1075	1	1.5	Open Vent.	REV	BALL	1/2 X 5 1/2	7	A	128, 188, 14
D2714	PSC	.8	200-230/460	1075	1	4.6/2.3	Open Vent.	REV	BALL	1/2 X 5 1/2	8	A	128, 188, 95
D2715	PSC	.8	200-230/460	1075	1	4.6/2.3	Open Vent.	REV	BALL	5/8 X 5 1/2 Keyed	8	C	128, 188, 95
D2729	PSC	1/2	200-230/460	1075	1	4.6/2.3	Open Vent.	REV	BALL	1/2 X 3 1/2	6 1/4	D	128, 188, 13
3 PHASE MOTORS													
D2720	3 PH	3/4	200-230	1140	1	3	Open Vent.	REV	BALL	5/8 X 5 7/8 Keyed	8	C	
D2721	3 PH	3/4	460	1140	1	1.5	Open Vent.	REV	BALL	5/8 X 5 7/8 Keyed	8	C	
460 VAC MOTORS													
D1914	PSC	3/4	460	1050	1	1.7	Totally Encl.	REV	BALL	1/2 X 6	6	E	97, 12, 128, 188
D918	PSC	1/4 - 1/6	460	1625	2	1/6	Open Vent.	REV	BALL	1/2 X 6 1/2	4 1/4	F	98, 95, 128, 188
D916	PSC	1/2 - 1/3	460	1625	2	1.6/1.1	Open Vent.	REV	BALL	1/2 X 6 1/2	5 1/2	F	98, 13, 95, 128, 188
D960	PSC	1/3	460	825	1	1.3	Open Vent.	REV	BALL	1/2 X 6	5	G	
D921	PSC	1/3	230/460	825	1	2.7/1.4	Open Vent.	REV	BALL	1/2 X 6 3/8	5 1/4	H	95
D961	PSC	1/2	460	825	1	1.9	Open Vent.	REV	BALL	1/2 X 6	5 3/4	G	13
D920	PSC	1/2	460	825	1	2.1	Open Vent.	REV	SLV	1/2 X 4 1/2	5 1/2	I	24, 136
575 VAC MOTORS													
D2750	PSC	1/2	575	1625	1	1	Open Vent.	REV	BALL	1/2 X 6 1/2	5	J	128, 188, 14
D2751	PSC	1/3	575	1100	1	.75	Open Vent.	REV	BALL	1/2 X 6 1/2	5 1/4	J	128, 188, 14
D2752	PSC	.6	575	1075	1	1.1	Totally Encl.	REV	BALL	1/2 X 6 1/2	5 1/2	J	128, 188, 13
D2753	PSC	3/4	575	1075	1	1.8	Totally Encl.	REV	BALL	1/2 X 6 1/2	6	J	128, 188, 24

NOTES: 11: 5M 440V Capacitor 12: 10M 370V Capacitor 13: 7.5M 370V Capacitor 14: 7.5M 440V Capacitor 24: 15M 370V Capacitor 95: Comes with unmounted conduit box. 97: All angle mount bearings 98: All angle mount bearings. Use rainshield when necessary. 128: Electrically Reversible 136: Does not come with conduit box. 188: 60° ambient temperature rating



FIG. A D2710, D2713, D2714



FIG. B D2711



FIG. C D2712, D2715, D2720, D2721



FIG. D D2729



FIG. E D1914



FIG. F D918, D916



FIG. G D960, D961



FIG. H D921



FIG. I D920



FIG. J D2750, D2751, D2752, D2753

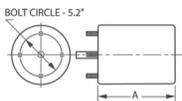

Thermally protected • UL recognized • CSA or ULc certified
NOTE: Rotation is determined by looking at shaft end. Shaft length is measured from motor face.

NEW ITEM! See page 113 for a complete listing of all our new products.

5.6" Diameter

Direct Drive Blower Motors



FASCO MODEL	TYPE	HP	VOLTS	RPM	SPD.	AMPS	ENCLOSURE	ROT.	BRNG.	SHAFT DIM.	"A" DIM.	FIG.	NOTES
OPEN VENTILATION													
D928	PSC	1/6 - 1/8 - 1/10	115	1075	3	2.7-2.1-1.7	Open Vent.	REV	SLV	1/2 X 5 1/4	3 3/4	A	99, 137, 128
D721	PSC	1/4 - 1/5 - 1/6	115	1075	3	4.8-3.3-2.6	Open Vent.	REV	SLV	1/2 X 6	4	A	99, 137, 128
D727	PSC	1/3 - 1/4 - 1/5	115	1075	3	5.9-4.6-3.8	Open Vent.	REV	SLV	1/2 X 6	4 1/4	A	99, 137, 128
D701	PSC	1/2 - 1/3 - 1/4 - 1/5	115	1075	4	7.7-5.5-4.2-3.3	Open Vent.	REV	SLV	1/2 X 5 1/2	5 1/4	A	99, 137, 12, 128
D726	PSC	3/4 - 1/3	115	1075	2	11-5	Open Vent.	REV	SLV	5/8 X 4 1/2 Keyed	5 1/4	B	99, 137, 24, 128
D728	PSC	3/4 - 1/2 - 1/3	115	1075	3	10.5-6.9-4.8	Open Vent.	REV	SLV	1/2 X 6	5 1/2	A	99, 137, 12, 128
D724	PSC	3/4 - 1/2 - 1/3 - 1/4	115	1075	4	9.5-7.2-5.6-3.5	Open Vent.	REV	SLV	1/2 X 6	5 3/4	C	99, 137, 24, 155, 128
D712	PSC	1 - 1/2 - 1/3	115	1075	3	11.8-6.3-3.9	Open Vent.	REV	SLV	1/2 X 6	6	A	99, 137, 15, 138, 128
D902	PSC	1/2 - 1/3 - 1/4 - 1/5	115	1075	4	9.9-5.6-3.7-2.7	Open Vent.	REV	SLV	1/2 X 5 1/2	5 1/4	A	99, 137, 12, 128
D1730	PSC	1/4 - 1/5 - 1/6	115	1075	3	4.8-3.3-2.6	Open Vent.	REV	SLV	1/2 X 6	4	D	
D1731	PSC	1/3 - 1/4 - 1/5	115	1075	3	5.9-4.6-3.8	Open Vent.	REV	SLV	1/2 X 6	4 1/4	D	
D1732	PSC	1/2 - 1/3 - 1/4	115	1075	3	7.7-5.5-4.2	Open Vent.	REV	SLV	1/2 X 6	4 3/4	D	12
D1733	PSC	1/4 - 1/5 - 1/6	208-230	1075	3	2.2-1.6-1.2	Open Vent.	REV	SLV	1/2 X 6	4	D	
D1734	PSC	1/3 - 1/4 - 1/5	208-230	1075	3	2.8-2.2-1.8	Open Vent.	REV	SLV	1/2 X 6	4 1/4	D	
D1735	PSC	1/2 - 1/3 - 1/4	208-230	1075	3	3.4-2.5-1.9	Open Vent.	REV	SLV	1/2 X 6	4 3/4	D	
D2700	PSC	1/2 - 1/3 - 1/4	115	1075	3	7.7/5.5/4.2	Open Vent.	REV	BALL	1/2 X 5 1/2	5 1/3	A	100
D2701	PSC	1/2 - 1/3 - 1/4	208/230	1075	3	4.0/2.7/2.0	Open Vent.	REV	BALL	1/2 X 6 1/4	5 1/8	E	101
D2702	PSC	3/4 - 1/2 - 1/3	115	1075	3	10.5/5.6/4.8	Open Vent.	REV	BALL	1/2 X 6 1/4	5 1/2	A	100
D2703	PSC	3/4 - 1/2 - 1/3	208/230	1075	3	5.4/3.8/2.9	Open Vent.	REV	BALL	1/2 X 6 1/4	5 1/2	E	100
D2704	PSC	1 - 1/2 - 1/3	208/230	1075	3	5.3/2.8/1.8	Open Vent.	REV	BALL	1/2 X 6 1/4	5 1/2	F	102
D2705	PSC	1 - 1/2 - 1/3	115	1075	3	11.6/6.3/3.9	Open Vent.	REV	BALL	1/2 X 6 1/4	6	A	102, 138
D927	PSC	1/6 - 1/8 - 1/10	208-230	1075	3	1.4-.9-.5	Open Vent.	REV	SLV	1/2 X 7 1/2	3 3/4	A	98, 128
D725	PSC	1/4 - 1/6 - 1/8	208-230	1075	3	2.2-1.5-1.1	Open Vent.	REV	SLV	1/2 X 6	4	E	98, 128
D723	PSC	1/3 - 1/4 - 1/6	208-230	1075	3	3.3-2.3-1.8	Open Vent.	REV	SLV	1/2 X 6	4 1/2	E	98, 128
D923	PSC	1/3 - 1/4 - 1/5	208-230	1075	3	2.9-2.2-1.7	Open Vent.	REV	SLV	1/2 X 6	4 1/4	E	98, 128
D703	PSC	1/2 - 1/3 - 1/4	208-230	1075	3	4-2.7-2	Open Vent.	REV	SLV	1/2 X 6	5	E	98, 13, 128
D730	PSC	3/4 - 1/2	208-230	1075	2	4.8-3.5	Open Vent.	REV	BALL	1/2 X 6	5 1/2	E	98, 12, 128
D729	PSC	3/4 - 1/2 - 1/3	208-230	1075	3	5.4-3.8-2.9	Open Vent.	REV	SLV	1/2 X 6	5 1/2	E	98, 12, 128
D711	PSC	1 - 1/2 - 1/3	208-230	1075	3	5.3-2.8-1.8	Open Vent.	REV	SLV	1/2 X 6	5 1/2	F	98, 15, 128

NOTES: 12: 10M 370V Capacitor 13: 7.5M 370V Capacitor 15: 20M 370V Capacitor 24: 15M 370V Capacitor 98: All angle mount bearings. Use rain-shield when necessary. 99: All angle mount bearings. 100: 10 MFD 370V 101: 7.5 MFD 370V 102: 20 MFD 370V 128: Electrically Reversible 137: Ideal for blowers and fans used in furnaces and air-conditioners. 138: Not CSA certified 155: Includes 8 drilled and tapped holes in shell.



FIG. A D928, D721, D727, D701, D728, D712, D902, D2700, D2702, D2705, D927



FIG. B D726



FIG. C D724



FIG. D D1730, D1731, D1732, D1733, D1734, D1735



FIG. E D2701, D2703, D725, D723, D923, D703, D730, D729



FIG. F D2704, D711

FASCO MODEL	TYPE	HP	VOLTS	RPM	SPD.	AMPS	ENCLOSURE	ROT.	BRNG.	SHAFT DIM.	"A" DIM.	FIG.	NOTES
D975	PSC	1/6 - 1/10 - 1/12	277	1075	3	.9-.4-.3	Open Vent.	REV	SLV	1/2 X 5 1/2	4	A	103, 128, 97
D979	PSC	1/6 - 1/8 - 1/10	277	1075	3	.9-.7-.6	Open Vent.	DS	SLV	7 7/8 X 1/2 X 8 1/4	3 3/4	B	103, 128, 97
D973	PSC	1/4 - 1/6 - 1/8	277	1075	3	2-1.4-1	Open Vent.	REV	SLV	1/2 X 5 1/2	4	A	103, 128, 97
D972	PSC	1/3 - 1/4 - 1/5	277	1075	3	2.4-1.5-1	Open Vent.	REV	SLV	1/2 X 5 1/2	4 1/4	A	103, 128, 97
D971	PSC	1/2 - 1/3 - 1/4	277	1075	3	3.2-2.2-1.8	Open Vent.	REV	SLV	1/2 X 5 1/2	4 3/4	A	103, 12, 97
D976	PSC	1/2 - 1/3 - 1/4	277	1075	3	3.4-2.2-1.6	Open Vent.	DS	SLV	7 3/8 X 1/2 X 7 1/4	5 1/4	B	103, 12, 97
D974	PSC	1/2 - 1/3 - 1/4	277	825	3	2.3-1.6-1.3	Open Vent.	REV	SLV	1/2 X 5	5 1/3	C	103, 24, 97
D970	PSC	3/4 - 1/2 - 1/3	277	1075	3	3.9-2.2-1.6	Open Vent.	REV	SLV	1/2 X 5 1/2	5 1/4	A	103, 15, 97
D1703	PSC	1/4 - 1/6 - 1/8	115	1075	3	4.1- 3-2.3	Totally Encl.	DS	SLV	8 X 1/2 X 8	4 1/4	D	
D1704	PSC	1/3 - 1/4 - 1/6	115	1075	3	4.9-3.1-2.2	Totally Encl.	DS	SLV	8 X 1/2 X 8	4 3/4	D	
D1705	PSC	1/2 - 1/3 - 1/4	115	1075	3	8.7-6.2- 4.9	Totally Encl.	DS	SLV	8 X 1/2 X 8	5 3/4	D	
D1706	PSC	1/4 - 1/6 - 1/8	208-230	1075	3	1.7-1.3-1	Totally Encl.	DS	SLV	8 X 1/2 X 8	4 1/4	D	
D1707	PSC	1/3 - 1/4 - 1/6	230	1075	3	2.3-1.5-1.1	Totally Encl.	DS	SLV	8 X 1/2 X 8	4 3/4	D	
D1708	PSC	1/2 - 1/3 - 1/4	230	1075	3	4.1- 3-2.3	Totally Encl.	DS	SLV	8 X 1/2 X 8	5 3/4	D	
D736	PSC	1/6	115	1625	1	2	Totally Encl.	REV	BALL	1/2 X 3 1/4	4 1/4	E	104, 128, 152, 97
D834	PSC	1/6	115	1075	1	2.7	Totally Encl.	CW	BALL	1/2 X 3	4 1/4	F	104, 152, 97
D733	PSC	1/6 - 1/8	115	1075	2	2.5-1.8	Totally Encl.	REV	BALL	1/2 X 4 1/2	4 1/4	G	97, 128, 152
D734	PSC	1/4	115	1075	1	3.8	Totally Encl.	REV	BALL	1/2 X 3 1/4	4 1/4	E	104, 13, 152, 97
D732	PSC	1/3	115	1075	1	4.1	Totally Encl.	REV	BALL	1/2 X 5	4 3/4	F	104, 128, 152, 97
D817	PSC	1/2	115	1140	1	5.5	Totally Encl.	CW	BALL	1/2 X 6	4 1/2	E	104, 97, 152

NOTES: 12: 10M 370V Capacitor 13: 7.5M 370V Capacitor 15: 20M 370V Capacitor 24: 15M 370V Capacitor 97: All angle mount bearings 103: Ideal for blowers and fans used in furnaces and air-conditioners 104: The capacitor and base are included 128: Electrically Reversible 152: Ideal for unit heaters



FIG. A D975, D973, D972, D971, D970



FIG. B D979, D976



FIG. C D974



FIG. D D1703, D1704, D1705, D1706, D1707, D1708



FIG. E D736, D734, D817



FIG. F D834, D732



FIG. G D733

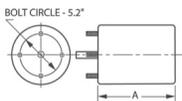

Thermally protected • UL recognized • CSA or ULc certified
 NOTE: Rotation is determined by looking at shaft end. Shaft length is measured from motor face.

NEW ITEM! See page 113 for a complete listing of all our new products.

5.6" Diameter

Window A/C, Condenser Fan & Direct Drive Blower Motors



FASCO MODEL	TYPE	HP	VOLTS	RPM	SPD.	AMPS	ENCLOSURE	ROT.	BRNG.	SHAFT DIM.	"A" DIM.	FIG.	NOTES
D782	PSC	1/4	115	1625	1	3.5	Open Vent.	REV	SLV	1/2 X 6	4 1/4	A	191
D783	PSC	1/4	208-230	1625	1	1.5	Open Vent.	REV	SLV	1/2 X 6	4	B	191
D780	PSC	1/3 - 1/4 - 1/6	115	1625	3	4.7-3.5-2.7	Open Vent.	REV	SLV	1/2 X 6	4 1/2	A	191
D787	PSC	1/3	208-230	1625	1	2.3	Open Vent.	REV	SLV	1/2 X 7	4 1/4	B	191
D781	PSC	1/3 - 1/4 - 1/6	208-230	1625	3	2-1.6-1.2	Open Vent.	REV	SLV	1/2 X 7	4 1/2	B	191
D785	PSC	1/2 - 1/3 - 1/4	115	1625	3	8.4-6.4-5	Open Vent.	REV	SLV	1/2 X 6	4 3/4	A	191
D788	PSC	1/2	208-230	1625	1	3.9	Open Vent.	REV	SLV	1/2 X 6	5	B	191
D784	PSC	1/2 - 1/3 - 1/4	208-230	1625	3	3.8-2.8-2.1	Open Vent.	REV	SLV	1/2 X 6	5	B	191
D789	PSC	3/4	208-230	1625	1	5.2	Open Vent.	REV	SLV	1/2 X 6	5 1/4	C	13, 191
D786	PSC	3/4 - 1/2 - 1/3	230	1625	3	5.3-3.8-2.9	Open Vent.	REV	SLV	1/2 X 6	5 1/4	C	13, 191
D776	PSC	1/5 - 1/8 - 1/10	115	1625	3	2.8-2-1.6	Open Vent.	DS	SLV	8 1/2 X 1/2 X 8 1/2	3 1/2	D	192, 162
D775	PSC	1/5 - 1/6 - 1/8	208-230	1625	3	1.1-8-.7	Open Vent.	DS	SLV	8 1/2 X 1/2 X 8 1/2	3 1/2	D	192, 162
D773	PSC	1/4 - 1/5 - 1/6	115	1625	3	3.8-2.8-2.1	Open Vent.	DS	SLV	8 1/2 X 1/2 X 8 1/2	4	D	192, 162
D774	PSC	1/4 - 1/5 - 1/6	208-230	1625	3	1.9-1.2-.9	Open Vent.	DS	SLV	8 1/2 X 1/2 X 8 1/2	4	D	192, 162
D770	PSC	1/3 - 1/4 - 1/6	115	1625	3	5.9-4.4-3.5	Open Vent.	DS	SLV	8 3/4 X 1/2 X 8 3/4	4 1/2	D	192, 162
D771	PSC	1/3 - 1/4 - 1/6	208-230	1625	3	2.4-1.8-1.4	Open Vent.	DS	SLV	8 3/4 X 1/2 X 8 3/4	4 1/2	D	192, 162
D777	PSC	1/2 - 1/3 - 1/4	115	1625	3	9.4-6-4.5	Open Vent.	DS	SLV	7 1/2 X 1/2 X 7 1/2	5	D	192, 162
D772	PSC	1/2 - 1/3 - 1/4	208-230	1625	3	3.8-2.8-2.1	Open Vent.	DS	SLV	8 X 1/2 X 8	4 3/4	D	192, 162
D778	PSC	3/4 - 1/2 - 1/3	208-230	1625	3	5.3-3.8-3.2	Open Vent.	DS	SLV	7 1/2 X 1/2 X 7	5 1/4	E	192, 162

NOTES: 13: 7.5M 370V Capacitor 162: Ideal for lug mounting using lug Kit 55L or 55S 191: Should not be used for replacements where original motor is rated below 1500 RPM 192: Ideal versatility using Kit 200 "X" brackets to accommodate various cradle base lengths



FIG. A D782, D780, D785



FIG. B D783, D787, D781, D788, D784



FIG. C D789, D786



FIG. D D776, D775, D773, D774, D770, D771, D777, D772



FIG. E D778



FASCO MODEL	TYPE	HP	VOLTS	RPM	SPD.	AMPS	ENCLOSURE	ROT.	BRNG.	SHAFT DIM.	"A" DIM.	FIG.	NOTES
D751	PSC	1/8 - 1/10 - 1/15	115	1075	3	2.3-1.5-1.1	Open Vent.	DS	SLV	7 1/2 X 1/2 X 9	3 1/2	A	192, 157, 162, 161
D750	PSC	1/8 - 1/10 - 1/12	208-230	1075	3	.9-.6-.5	Open Vent.	DS	SLV	7 1/2 X 1/2 X 9	3 3/4	A	192, 161, 162, 157
D754	PSC	1/6 - 1/8 - 1/10	115	1075	3	2.7-2.1-1.7	Open Vent.	DS	SLV	7 1/2 X 1/2 X 9	3 1/2	A	192, 161, 162, 157
D752	PSC	1/6 - 1/8 - 1/10	208-230	1075	3	1.4-.9-.5	Open Vent.	DS	SLV	7 1/2 X 1/2 X 9	3 1/2	A	192, 161, 162, 157
D756	PSC	1/4 - 1/6 - 1/8	115	1075	3	3.9-2.4-2.1	Open Vent.	DS	SLV	10 X 1/2 X 10	4	A	192, 161, 162, 157
D755	PSC	1/4 - 1/6 - 1/8	208-230	1075	3	2-1.4-1.2	Open Vent.	DS	SLV	7 1/2 X 1/2 X 8 1/2	4	A	192, 161, 162, 157
D757	PSC	1/3 - 1/4 - 1/6	115	1075	3	6.9-4.8-3.8	Open Vent.	DS	SLV	8 1/2 X 1/2 X 8 1/2	4 1/4	A	192, 161, 162, 157
D758	PSC	1/3 - 1/4 - 1/6	208-230	1075	3	2.3-1.7-1.1	Open Vent.	DS	SLV	8 1/2 X 1/2 X 8 1/2	4 1/2	A	192, 161, 162, 157
D761	PSC	1/2 - 1/3 - 1/4	115	1075	3	9.6-6-4.4	Open Vent.	DS	SLV	8 X 1/2 X 8	5 1/4	A	192, 161, 162, 157
D760	PSC	1/2 - 1/3 - 1/4	208-230	1075	3	4.3-3.1-2.3	Open Vent.	DS	SLV	8 X 1/2 X 8	5 1/4	A	192, 161, 162, 157
D769	PSC	3/4 - 1/2 - 1/3	115	1075	3	11.9-8.1-6	Open Vent.	DS	SLV	8 X 1/2 X 8	5 1/2	A	192, 12, 162, 157, 161
D763	PSC	3/4 - 1/2 - 1/3	208-230	1075	3	5.7-4.1-3.1	Open Vent.	DS	SLV	8 X 1/2 X 8	5 1/2	A	192, 12, 162, 157, 161
D766	PSC	1/4 - 1/6 - 1/8	230	1075	3	1.9-1.2-.8	Totally Encl.	DS	SLV	7 1/2 X 1/2 X 8 1/2	4	B	192, 128, 162, 157, 161

NOTES: 12: 10M 370V Capacitor 128: Electrically Reversible 157: All angle mount sleeve bearings 161: Hubless endshields for flush mounting
 162: Ideal for lug mounting using lug Kit 55L or 55S 192: Ideal versatility using Kit 200 "X" brackets to accommodate various cradle base lengths



FIG. A D751, D750, D754, D752, D756, D755, D757, D758, D761, D760, D769, D763



FIG. B D766

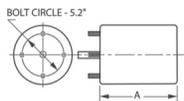

Thermally protected • UL recognized • CSA or ULc certified
NOTE: Rotation is determined by looking at shaft end. Shaft length is measured from motor face.

NEW ITEM! See page 113 for a complete listing of all our new products.

5.6" Diameter

50Hz Export Motors



FASCO MODEL	TYPE	HP	VOLTS	RPM	SPD.	AMPS	ENCLOSURE	ROT.	BRNG.	SHAFT DIM.	"A" DIM.	FIG.	NOTES
D3775	PSC	1/6 - 1/8 - 1/10	230	1350	3	.8-.6-.5	Totally Encl.	DS	SLV	7 3/4 X 1/2 X 7 3/4	3.5/89	A	139
D3774	PSC	1/4 - 1/5 - 1/6	230	1350	3	1.5-1.1-.8	Totally Encl.	DS	SLV	7 1/2 X 1/2 X 7 1/2	4.0/102	A	106, 139
D3771	PSC	1/3 - 1/4 - 1/5	230	1350	3	2.1-1.5-1.1	Open Vent.	DS	SLV	7 1/4 X 1/2 X 7 1/4	4.5/114	B	139
D3772	PSC	1/2 - 1/3 - 1/4	230	1350	3	3-1.9-1.3	Open Vent.	DS	SLV	7 X 1/2 X 7	4.8/122	B	12, 139
D3752	PSC	1/6 - 1/8 - 1/10	230	900	3	1.2-.8-.6	Totally Encl.	DS	SLV	7 1/2 X 1/2 X 7 1/2	4.0/102	A	139
D3755	PSC	1/4 - 1/5 - 1/6	230	900	3	2-1.4-1	Totally Encl.	DS	SLV	7 1/4 X 1/2 X 7 1/4	4.5/114	A	106, 139
D3758	PSC	1/3 - 1/4 - 1/5	230	900	3	2.6-1.7-1.3	Open Vent.	DS	SLV	7 X 1/2 X 6 3/4	5.3/135	B	139
D3760	PSC	1/2 - 1/3 - 1/4	230	900	3	4.2-2.2-1.5	Open Vent.	DS	SLV	7 X 1/2 X 7	5.5/140	B	12, 139

NOTES: 12: 10M 370V Capacitor 106: Includes dust seal 139: All angle mount bearings. Use rainshield when necessary



FIG. A D3775, D3774, D3752, D3755
FIG. B D3771, D3772, D3758, D3760



FASCO MODEL	TYPE	HP	VOLTS	RPM	SPD.	AMPS	ENCLOSURE	ROT.	BRNG.	SHAFT DIM.	"A" DIM.	FIG.	NOTES
D824	PSC	1/4 - 1/8	115	1100	2	3.2-2.4	Totally Encl.	REV	BALL	1/2 X 3 1/2	5 3/4	A	107, 28, 140
D901	PSC	1/3 - 1/8	115	1100	2	4-3.5	Totally Encl.	REV	BALL	1/2 X 3 1/2	6	A	107, 140
D997	PSC	1/2 - 1/4	115	1100	2	7.1-4	Totally Encl.	REV	SLV	1/2 X 3	7 1/3	A	107, 140, 108
D999	PSC	1/2 - 1/4	115	1100	2	7.1-4	Totally Encl.	REV	SLV	5/8 X 3	7 1/3	A	107, 140, 108
D900	PSC	1/2 - 1/4	115	1100	2	7.1-4	Totally Encl.	REV	SLV	5/8 X 3	7 1/4	B	108, 108
D998	PSC	1/2	115/230	825	1	6-3	Totally Encl.	CW	BALL	5/8 X 2 5/8	7 1/2	C	109, 141, 153, 193

NOTES: 28: 4MFD 370V Capacitor included 107: Includes pull-chain switch 108: 12.5MFD 370V capacitor included 109: No pedestal yoke mount
 140: Has 10' cordset 141: Keyed shaft 153: Agricultural applications 193: Poultry and Hog House fan motor



FIG. A D824, D901, D997, D999



FIG. B D900



FIG. C D998

Thermally protected • UL recognized • CSA or ULc certified

NOTE: Rotation is determined by looking at shaft end. Shaft length is measured from motor face.



FASCO MODEL	TYPE	HP	VOLTS	RPM	SPD.	ENCLOSURE	ROT.	BRING.	SHAFT DIM.	RING TO RING	FIG.	NOTES
FRAME MOTORS												
D6002	SPLIT PHASE	1/4	115/230	1725	1	OPEN DRIP PROOF	REV	BALL	1/2 X 1-1/2	7.435	A	46, 125, 144
D6004	SPLIT PHASE	1/3	115/230	1725	1	OPEN DRIP PROOF	REV	BALL	1/2 X 1-1/2	7.935	A	46, 125, 144
D6006	SPLIT PHASE	1/2	115/230	1725	1	OPEN DRIP PROOF	REV	BALL	1/2 X 1-1/2	8.435	A	46, 125, 144
D6082	CAPACITOR START	1/3	115/208-230	1725	1	OPEN DRIP PROOF	REV	BALL	5/8 X 2	7.945	B	144, 125
NEMA 56 FRAME CAPACITOR START MOTORS												
D6084	CAPACITOR START	1/2	115/208-230	1725	1	OPEN DRIP PROOF	REV	BALL	5/8 X 2	8.445	B	144, 125
D6066	CAPACITOR START	3/4	115/208-230	3450	1	OPEN DRIP PROOF	REV	BALL	5/8 X 2	9.445	B	144, 125
D6086	CAPACITOR START	3/4	115/208-230	1725	1	OPEN DRIP PROOF	REV	BALL	5/8 X 2	9.445	B	144, 125
D6068	CAPACITOR START	1	115/208-230	3450	1	OPEN DRIP PROOF	REV	BALL	5/8 X 2	9.445	C	144, 125
D6088	CAPACITOR START	1	115/208-230	1725	1	OPEN DRIP PROOF	REV	BALL	5/8 X 2	9.445	C	144, 125
D6070	CAPACITOR START	1.5	115/208-230	3450	1	OPEN DRIP PROOF	REV	BALL	5/8 X 2	9.445	C	144, 125
D6090	CAPACITOR START	1.5	115/208-230	1725	1	OPEN DRIP PROOF	REV	BALL	5/8 X 2	10.445	C	47, 125, 144
D6073	CAPACITOR START	2	115/208-230	3450	1	OPEN DRIP PROOF	REV	BALL	5/8 X 2	10.445	C	144, 125
D6093	CAPACITOR START	2	115/208-230	1725	1	OPEN DRIP PROOF	REV	BALL	5/8 X 2	10.945	C	47, 125, 144
NEMA 56 FRAME DRIP PROOF												
D6622	3 PHASE	1/3	208-230/460	1725	1	OPEN DRIP PROOF	REV	BALL	5/8 X 2	8.445	D	144, 125
D6624	3 PHASE	1/2	208-230/460	1725	1	OPEN DRIP PROOF	REV	BALL	5/8 X 2	8.945	D	144, 125
D6626	3 PHASE	3/4	208-230/460	1725	1	OPEN DRIP PROOF	REV	BALL	5/8 X 2	9.945	D	144, 125
D6628	3 PHASE	1	208-230/460	1725	1	OPEN DRIP PROOF	REV	BALL	5/8 X 2	9.445	E	144, 125
D6630	3 PHASE	1.5	208-230/460	1725	1	OPEN DRIP PROOF	REV	BALL	5/8 X 2	9.945	E	144, 125
D6631	3 PHASE	2	208-230/460	1725	1	OPEN DRIP PROOF	REV	BALL	5/8 X 2	9.945	E	47, 125, 144
D6633	3 PHASE	3	208-230/460	1725	1	OPEN DRIP PROOF	REV	BALL	7/8 X 2-3/8	11.445	E	48, 125, 144
NEMA 56Y FRAME CONDENSER FAN MOTORS												
D6608	3 PHASE	1	208-230/460	1140	1	OPEN VENTILATED	REV	BALL	5/8 X 3-3/4		F	194
D6610	3 PHASE	1.5	208-230/460	1140	1	OPEN VENTILATED	REV	BALL	5/8 X 3-3/4		F	194

NOTES: ,46: Belted Fan & Blower Motor ,47: 56H Mounting ,48: 145T Frame ,125: Continuous Duty ,144: Resilient Base ,194: Condenser Fan Motor



FIG. A D6002, D6004, D6006



FIG. B D6082, D6084, D6066, D6086



FIG. C D6068, D6088, D6070, D6090, D6073, D6093



FIG. D D6622, D6624, D6626



FIG. E D6628, D6630, D6631, D6633



FIG. F D6608, D6610



FASCO MODEL	TYPE	VOLTS	SPD.	AMPS	CROSS REF.	FIG.	NOTES
A087	PSC	115/230	1	2.8/1.1	Air Plus 7062-4687, Scherba Industries 7062-3496	A	
A120	SP	120	2	1.1	Aladdin Steel 7002-2983	B	
A129	SP	115	1	1.95	Amana 7021-9064, 7021-9259	C	
A158	PSC	115	1	0.7	Amana 7062-3151	D	
A160	SP	115	1	1.6	Amana 7002-2407	E	
A085	SP	230	1	0.7	AO Smith 464, Johnson Furnace	F	
A155	SP	115	1	1.4	Armstrong 7021-10046	G	
A161	SP	230	1	0.6	Brinkley/ Fedders 8353920103	H	
A088	SP	115	1	1.3	Coleman 7021-6759, Dornback 7021-5478, York 7021-8629, 7021-7105	I	
A128	SP	120	1	0.9	Consolidated Ind. 7021-6376, 7021-9404	J	
A156	SP	115	1	1.1	Evcon 7021-8935	K	
A100	SP	115	1	1.21	Excel Comfort 7058-0280	L	
A159	SP	230	1	0.5	Fedders 11-7096, AK4K84BX	M	
B23617	SP	115/230	1	.9/4	Franklin 80270	N	
B23618	SP	115/208-230	1	.95/4.9	Franklin 80270	O	
A110	SP	115	1	0.76	Frymaster 7002-3512	P	
A111	SP	208-240	1	0.8	Frymaster 7021-11714	Q	



FIG. A A087



FIG. B A120



FIG. C A129



FIG. D A158



FIG. E A160



FIG. F A085



FIG. G A155



FIG. H A161



FIG. I A088



FIG. J A128



FIG. K A156



FIG. L A100



FIG. M A159



FIG. N B23617



FIG. O B23618



FIG. P A110



FIG. Q A111

Thermally protected • UL recognized • CSA or ULc certified
NOTE: Rotation is determined by looking at shaft end. Shaft length is measured from motor face.



FASCO MODEL	TYPE	VOLTS	SPD.	AMPS	CROSS REF.	FIG.	NOTES
A065	SP	115	1	1.22	Goodman 0131M00002P, 110276-00	A	
A140	SP	115	1	1.4	Goodman 7021-9087, 7021-9000	B	
A157	SP	115	1	1.3	Goodman 7002-2307	C	
A162	SP	208-230	1	0.5	Goodman 7021-8656	D	
A180	SP	115	1	1.8	Goodman 7021-9625, 20190601	E	
A181	SP	115	1	1.5	Goodman 7058-0136, 20044403	F	
A182	SP	115	1	1.2	Goodman 7002-3036, B4059000	G	
A184	SP	115	1	1.55	Goodman 7058-0229, B40590-01	H	
A185	SP	115	1	1.15	Goodman 7021-9316, 105854-04	I	
A187	SP	208-230	1	0.8	Goodman 7021-10006, 20028901	J	
A188	SP	115	1	1.6	Goodman 7021-10958, B4833000	K	
A189	SP	115	1	1.5	Goodman 7021-7302, D9868620	L	
A280	SP	115	1	1.5	Goodman 7021-7794, D986868	L	
A281	SP	115	1	0.9	Goodman 7021-8252, D6996405	M	
A282	SP	220	1	0.45	Goodman 7021-8448, B1859050S	N	
A283	SP	115	1	1.5	Goodman 7021-8730, D9868617	L	
A284	SP	208/240	1	.59/.5	Goodman 7021-9227, D9886202	M	
A285	SP	115	2	1.4	Goodman 7021-9236, B2833002	B	
A286	SP	208/230	1	0.6	Goodman 7021-9398, 11096904	I	
A287	SP	115	1	1.15	Goodman 7021-9655, 10585405	I	
A288	SP	115	2	1.4/.65	Goodman 7021-9727, 11177202	I	
A289	SP	208/230	1	0.75	Goodman 7058-0081, 20351402	F	
A290	PSC	115	2	0.7	Goodman 7062-5015, 20245903	O	



FIG. A A065



FIG. B A140, A285



FIG. C A157



FIG. D A162



FIG. E A180



FIG. F A181, A289



FIG. G A182



FIG. H A184



FIG. I A185, A286, A287, A288



FIG. J A187



FIG. K A188



FIG. L A189, A280, A283



FIG. M A281, A284



FIG. N A282



FIG. O A290

FASCO MODEL	TYPE	VOLTS	SPD.	AMPS	ROT.	CROSS REF.	FIG.	NOTES
A133	SP	115	1	1.2		Heat n' Glow 7002-1241	A	
A064	SP	115	1	0.7		Heil Quaker 610172, 7021-5043, 7021-7102	B	
A051	SP	115	1	1.6		ICP 1013833, J238-1393	C	
A067	SP	115	1	2.6		ICP 1014338, 119225-00	D	
A134	SP	115	1	1.5	CW	ICP 7021-9335, 7021-8735, 7021-9499, 7021-8736, 7021-7700	E	
A145	PSC	115	1	0.7	CCW	ICP 7062-4061	F	
A141	SP	115	1	1	CW	ICP 7021-8741, 7021-8742	G	
A148	SP	208-230	1	0.5	CCW	ICP 7021-7617, 7021-9237	H	
A151	SP	230	1	0.3	CW	ICP HQ1050144	I	
A169	SP	230	1	0.75	CW	ICP 7021-10048, 7021-10580	J	
A170	SP	115	1	2.3		ICP 7021-10299, 7021-10702	K	
A171	PSC	115	1	0.7		ICP 7062-4783, 1011412, 7062-4705, 7062-4274, 7062-4201, 7062-4549	L	
A172	SP	115	1	1.6		ICP 7002-2792, 1010975P, 7002-2633	M	
A173	PSC	115	1	0.8		ICP 1011350, Alltemp (Rotom)7062-4578, 7062-4832	N	
A174	SP	115	1	0.8		ICP 7021-9188, 1010239	G	
A175	SP	115	1	1		ICP 7002-1891, 1708-600P	O	
A176	SP	115	1	2.2		ICP 7002-2946, 1011899, 7002-3071, 1011899P	P	
A177	SP	115	2	1.4		ICP 7021-10363, 1011632, 7021-10597, 1011632P	E	
A178	SP	115	1	1.8		ICP 7021-10928, 10113388FA	Q	
A179	SP	115	1	0.9		ICP 7021-8693, 1006168P	R	
A301	SP	115	1	0.8		ICP 7021-9498, 1010239P	G	
A302	SP	115	1	1.5		ICP 7021-9499, 1010324P, 7021-7700, 1708-607	E	
A304	SP	115	1	1.5		ICP 7021-9701, 1011021	E	
A306	PSC	208-230	2	0.3		ICP 7062-4532, 1097245	S	
A307	PSC	115	1	0.7		ICP 7062-5165	T	



FIG. A A133



FIG. B A064



FIG. C A051



FIG. D A067



FIG. E A134, A177, A302, A304



FIG. F A145



FIG. G A141, A174, A301



FIG. H A148



FIG. I A151



FIG. J A169



FIG. K A170



FIG. L A171



FIG. M A172



FIG. N A173



FIG. O A175



FIG. P A176



FIG. Q A178



FIG. R A179



FIG. S A306



FIG. T A307

Thermally protected • UL recognized • CSA or ULc certified
NOTE: Rotation is determined by looking at shaft end. Shaft length is measured from motor face.



FASCO MODEL	TYPE	VOLTS	SPD.	AMPS	CROSS REF.	FIG.	NOTES
A068	SP	120	1	1.15	Lennox 88K8401, J238-8171	A	
A135	SP	120	1	0.7	Lennox 7021-8812, 7021-8819	B	
A138	SP	120	1	0.7	Lennox 7021-8657, 7021-8825	C	
A163	SP	115	1	1.8	Lennox 7021-9450	D	
A164	SP	120	1	0.8	Lennox 7021-9593	E	
A200	SP	115	1	1.95	Lennox 7002-2975	F	
A201	SP	208-230	1	0.65	Lennox 7021-10055, 7021-10743	G	
A202	SP	115	1	1.8	Lennox 7021-10602, 7021-11106, 7021-11174	H	
A203	SP	115	1	1.8	Lennox 7021-10841	I	
A204	SP	115	1	1.8	Lennox 7021-11406	J	
A205	SP	120	1	0.7	Lennox 7021-8372, 7021-9001	B	
A206	SP	115	1	1.5	Lennox 7021-8473, 7021-8983	K	
A207	SP	115	1	1.75	Lennox 7058-0217	L	
A208	SP	115	1	1.75	Lennox 7058-0322	M	
A209	PSC	115	2	0.8	Lennox 7062-5441	N	
A210	SP	115	2	1.7	Lennox 7021-11063	O	
A211	SP	115	1	2.35	Lennox 7021-11634	P	
A213	SP	115	2	2.1	Lennox 7021-10376, 18L0401	D	
A216	SP	115	2	2.1	Lennox 7021-10915, 60L1401	D	
A217	SP	230	1	0.83	Lennox 7021-11231, 25M5501	Q	



FIG. A A068



FIG. B A135, A205



FIG. C A138



FIG. D A163, A213, A216



FIG. E A164



FIG. F A200



FIG. G A201



FIG. H A202



FIG. I A203



FIG. J A204



FIG. K A206



FIG. L A207



FIG. M A208



FIG. N A209



FIG. O A210



FIG. P A211



FIG. Q A217



FASCO MODEL	TYPE	VOLTS	SPD.	AMPS	CROSS REF.	FIG.	NOTES
A218	SP	220-240	1	.60/.52	Lennox 7021-10676, 39L4201, 7021-8959, 60J4201	A	
A219	SP	120	1	0.7	Lennox 7021-9262, 88J3901	B	
A320	SP	115	1	.8	Lennox 7021-9646, 101154-01 7021-9466	B	
A322	SP	120	2	1.1	Lennox 7021-9884, 83L8201	C	
A324	PSC	230	1	.44	Lennox 7062-1909, 28G6601, 7062-1794	D	
A325	PSC	208-230	1	0.6	Lennox 7062-2845, 7062-4751, 98G8701	E	
A329	PSC	208-230	1	0.5	Lennox 7062-4819, 19L1501	F	
A330	PSC	208-230	1	0.55	Lennox 7062-5546, 7062-4517, 7062-4608, 7062-4083, 69M3301	G	
A331	PSC	460	1	.38/.33	Lennox 7062-5554, 69M3201, 7062-4051, 7062-4518, 97J8101	G	
A081	SP	230	1	0.5	Magic Chef/HWC Series 48HWC24A, 48HWC181, 35HWC181, 60HW, 60HWC24A, 60HWC181, 48HW, 60HWC30A, 66HWC18A, 36HWC241, 66HW, 60HWC241, 66HWC181, 66HWC241, 60HWC301, 48HWC241, 66HWC301, 48HWC18A, 60HWC18A, 36HWC18A, 66HWC24A, 36HW, 36HWC24A	H	
A131	SP	115	1	1.1	Nordyne 7021-9132, 7021-10171, 7021-10159, 7021-9661	I	
A132	SP	115	1	1.1	Nordyne 7021-7975, 6212850	J	
A121	SP	240	1	0.51	Nordyne 7021-10381, 6217930	K	
A122	SP	115	1	1.75	Nordyne 7021-11227, 6219490	L	
A123	SP	115	1	1.95	Nordyne 7021-11385, 622064	M	
A124	SP	115	1	1.75	Nordyne 7021-11379, 6219290	N	
A126	SP	115	1	1.8	Nordyne 7002-3158, 6219500	O	
A079	SP	115	1	1.1	Rheem Ruud 74-70-21496-03-01, 74-70-21504-03-04, Goodman B1859000, 7021-6804, JA1M106, JA1M137, Trane B1W24, WG94X167	P	
A090	SP	115	1	1.1	70-21496-01, 7021-5239, JA1M102, 7021-5715	Q	



FIG. A A218



FIG. B A219, A320



FIG. C A322



FIG. D A324



FIG. E A325



FIG. F A329



FIG. G A330, A331



FIG. H A081



FIG. I A131



FIG. J A132



FIG. K A121



FIG. L A122



FIG. M A123



FIG. N A124



FIG. O A126



FIG. P A079



FIG. Q A090

Thermally protected • UL recognized • CSA or ULc certified
NOTE: Rotation is determined by looking at shaft end. Shaft length is measured from motor face.



FASCO MODEL	TYPE	VOLTS	SPD.	AMPS	CROSS REF.	FIG.	NOTES
A136	PSC	115	1	0.75	Rheem 7062-3861	A	
A139	SP	115	1	0.95	Rheem 7021-7577	B	
A086	SP	115	1	1.3	Rheem JA1N065, 7021-5239, JA1N062, Universal JA1N069, 20th Century 7021-5853, 7021-7104	C	
A142	PSC	115	1	0.7	Rheem 7062-1881, 7062-2615, PMI/Vulcan Hart 7062-2513, 416673-00003	D	
A066	SP	120	1	1.27	Rheem 70-24157-03, 117847-00	E	
A240	SP	115	1	1.1	Rheem 7021-8183	F	
A241	SP	208-230	1	0.62	Rheem 7021-9567	G	
A242	SP	115	1	1.36	Rheem 7021-7150	H	
A243	SP	115	1	1.36	Rheem 7021-7790	I	
A244	SP	208-230	1	0.85	Rheem 7021-6967	J	
A245	SP	208-230	1	.95/.85	Rheem 7021-7490	K	
A246	PSC	115	2	0.85	Rheem 7062-3925S, 7062-5272	L	
A247	PSC	115	2	0.95	Rheem 7062-5519S	M	
A251	SP	208-230	1	1.1	Skymark 7021-9136	N	
A073	SP	115-230	1	.7/.35	Tappan, Janitrol, SJC, Arkla, Franklin 8251560133, 829932, 8351520243	O	
A143	SP	115	1	0.95	Trane 7021-8428, 7021-8013, 7021-8924, 7021-9639, 7021-9055	P	
A146	SP	115	2	1-.35	Trane 7021-7986, 7002-2531, 7021-8925	Q	
A069	SP	208-240	1	0.5	Trane 38040252, 82252, 7021-6682	R	
A075	SP	230	1	0.4	Trane 38050005, 7021-6681, Franklin 82005	S	



FIG. A A136



FIG. B A139



FIG. C A086



FIG. D A142



FIG. E A066



FIG. F A240



FIG. G A241



FIG. H A242



FIG. I A243



FIG. J A244



FIG. K A245



FIG. L A246



FIG. M A247



FIG. N A251



FIG. O A073



FIG. P A143



FIG. Q A146



FIG. R A069



FIG. S A075



FASCO MODEL	TYPE	VOLTS	SPD.	AMPS	CROSS REF.	FIG.	NOTES
A130	PSC	115	1	0.7	Trane 7062-3956, 7021-4004, 7062-5247, D330757P04, 7062-3616, 7062-5575, D342094P04 Nordyne 7062-4159, 7062-4639	A	
A150	SP	208-230	1	0.5	Trane 7021-7833, 7021-8928	B	
A191	SP	208-230	1	0.8	Trane 7021-6683	C	
A192	SP	115	1	1	Trane 7021-8569	D	
A193	SP	208-240	1	.59/.5	Trane 7021-8591	E	
A194	SP	115	2	1/.5	Trane 7021-9561	F	
A195	SP	115	1	1.75	Trane 7021-11543S, 7021-11543	G	
A196	SP	115	1	1.35	Trane 7021-11544S, 7021-11544, 7021-9065	H	
A197	3 PHASE	33-110	VAR.	1	Trane 7092-0238S, 7092-0238	I	
A198	SP	115	1	1.75	Trane 7058-0259	J	
A199	SP	115	1	1.75	Trane 7058-0260	J	
A260	SP	115	1	1	Trane 7058-0261	J	
A261	SP	115	1	1	Trane 7058-0262	J	
A262	SP	115	1	1	Trane 7058-0263	J	
A263	SP	115	1	1	Trane 7058-0264	J	
A264	SP	115	2	0.75	Trane 7002-3443	J	
A265	SP	115	2	0.75	Trane 7002-3444	J	
A266	SP	115	2	1	Trane 7002-3445	J	
A267	SP	115	2	1.4	Trane 7002-3446	J	
A268	SP	115	2	1.4	Trane 7002-3447	J	
A269	SP	208-230	1	.58/.6	Trane 7021-11054	K	
A270	PSC	208-230	2	.42/.50	Trane 7062-5033	L	
A271	PSC	208-230	2	0.62	Trane 7062-3969	M	



FIG. A A130



FIG. B A150



FIG. C A191



FIG. D A192



FIG. E A193



FIG. F A194



FIG. G A195



FIG. H A196



FIG. I A197



FIG. J A198, A199, A260, A261, A262, A263, A264, A265, A266, A267, A268



FIG. K A269



FIG. L A270



FIG. M A271

Thermally protected • UL recognized • CSA or ULc certified
NOTE: Rotation is determined by looking at shaft end. Shaft length is measured from motor face.



FASCO MODEL	TYPE	VOLTS	SPD.	AMPS	CROSS REF.	FIG.	NOTES
A272	PSC	208-230	2	0.65	Trane 7062-3971	A	
A273	PSC	208-230	2	0.62	Trane 7062-3972	A	
A274	PSC	208-230	1	.28	Trane 7062-3973	A	
A276	SP	115	1	1	Trane 7021-9011	B	
A278	SP	115	2	1.4	Trane 7002-2530	C	
A279	SP	115	2	0.75	Trane 7002-2531	C	
A360	SP	115	2	1	Trane 7002-2532	C	
A361	SP	115	1	1.6	Trane 7002-2558	D	
A362	SP	115	1	1.6	Trane 7002-3273	C	
A367	SP	115	2	.95	Trane 7021-8051	E	
A368	PSC	115	2	0.8	Trane 7062-3782	F	
A369	PSC	208-230	2	.34	Trane 7062-3915	G	
A370	PSC	208-230	2	0.18	Trane 7062-3918	G	
A373	SP	208-230	1	0.6	Trane 7021-9396	H	
A118	SP	115	1	1.8	Williamson 7021-6999, 7021-7042	I	
A080	SP	115	1	1.1	Williamson 7021-5510, 02-568, Franklin F3670-1, Rotron RFB6	J	
A063	SP	230	1	0.6	York 026-22239-700, 7021-4314	K	
A083	SP	230	1	0.8	York 026-16323-0000, 02620224-000, 7021-1373	L	
A137	PSC	115	1	0.7	York 7062-2442, 7062-3484, 024-25057-000	M	
A144	SP	208-230	1	0.5	York 7021-6770	N	
A154	SP	115	1	1.2	York 7021-9428	O	



FIG. A A272, A273, A274



FIG. B A276



FIG. C A278, A279, A360, A362



FIG. D A361



FIG. E A367



FIG. F A368



FIG. G A369, A370



FIG. H A373



FIG. I A118



FIG. J A080



FIG. K A063



FIG. L A083



FIG. M A137



FIG. N A144



FIG. O A154



FASCO MODEL	TYPE	VOLTS	SPD.	AMPS	CROSS REF.	FIG.	NOTES
A165	PSC	115	1	0.7	York 7062-3958	A	
A168	PSC	115	1	0.7	York, Excel, Ducane 7062-5019	B	
A220	SP	115	1	1.6	York 7021-5838, 026-27510-700, 7021-7217, 7021-9054	C	
A221	SP	208-230	1	0.55	York 7021-8318, 026-30614-700, 7021-6691	D	
A222	SP	115	1	1.05	York 7021-8317, 026-32067-700, 7021-7481	E	
A223	SP	208-230	1	0.64	York 7021-10096, 026-33999-001, 7021-9656	F	
A224	SP	115	2	0.8	York 7062-5048, 024-27654-000, 7062-4743	G	
A225	SP	115	1	2.25	York 7021-11577, 17503, 7021-11577S, 7021-11830, 024-34558-000	H	
A226	SP	115	1	1.7	York 7058-0266, 7058-0266S	I	
A227	PSC	115	1	0.7	York 7062-4708S, 024-27641-000, 17450, 7062-4708	J	
A228	SP	115	1	2	York 7002-3285, 024-31957-000, 7002-2941	K	
A229	SP	115	1	1.75	York 7058-0267S, 17499, 7058-0267	L	
A230	PSC	115	2	0.8	York 7062-5094S, 17476, 7062-5094	M	
A231	SP	115	2	1.3	York 7021-10213, 17452	N	
A234	PSC	208-230	1	0.5	York 7062-5155, 102529	O	



FIG. A A165



FIG. B A168



FIG. C A220



FIG. D A221



FIG. E A222



FIG. F A223



FIG. G A224



FIG. H A225



FIG. I A226



FIG. J A227



FIG. K A228



FIG. L A229



FIG. M A230



FIG. N A231



FIG. O A234



Thermally protected • UL recognized • CSA or ULc certified
NOTE: Rotation is determined by looking at shaft end. Shaft length is measured from motor face.

Centrifugal Blowers

15 to 65 Free Air Output



MODEL	CFM AT STATIC PRESSURE SHOWN STATIC PRESSURE (INCHES OF WATER)									NAMEPLATE CFM	VOLTS	FREQ.	NO. OF SPEEDS	RPM@ FREE AIR	AMPS@ FREE AIR	BRNG.
	0.1	0.2	0.3	0.4	0.5	0.6	0.7	0.8	0.9							
50745-D500	6.5	-	-	-	-	-	-	-	-	15	115	60	1	3100	0.2	SLV
A167	30	27	25	5	-	-	-	-	-	30	115	60	1	2900	0.4	SLV
B30	40	37	32	22	6	-	-	-	-	45	115	60	1	3200	0.59	SLV
50747-D500	47	42	37	33	21	7	-	-	-	60	115	60	1	3200	0.52	SLV
50747-D600	47	42	37	33	21	7	-	-	-	60	115	60	1	3200	0.52	SLV
50747-D230	47	42	37	33	21	7	-	-	-	60	208-230	50/60	1	3200	0.26	SLV
50747-D401	47	42	37	33	21	7	-	-	-	60	115	50/60	1	3200	0.49	SLV
50748-D500	64	60	56	52	47	42	37	-	-	65	115	60	1	2900	0.81	SLV
50748-D700	64	60	56	52	47	42	37	-	-	65	115	60	1	2900	0.74	SLV
A063	69	65	62	57	52	42	37	30	-	65	230	60	1	3100	0.6	BALL



50745-D500

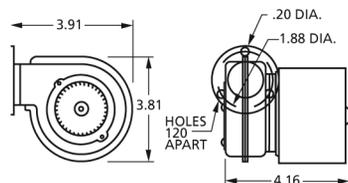

A167

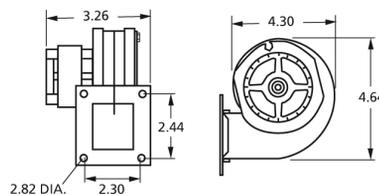

B30

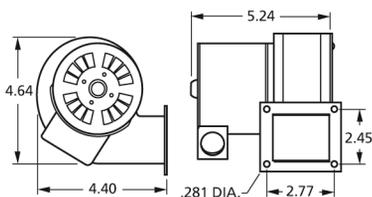

50747-D600

50747-D500

50747-D230

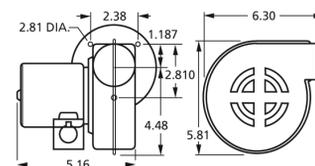

50747-D401

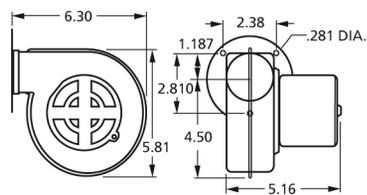

50748-D500

50748-D700

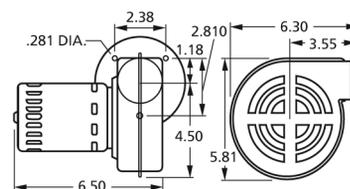

A063

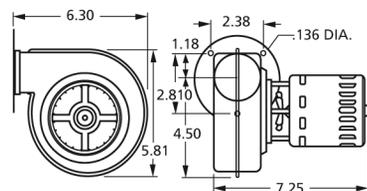



MODEL	CFM AT STATIC PRESSURE SHOWN STATIC PRESSURE (INCHES OF WATER)										NAMEPLATE CFM	VOLTS	FREQ.	NO. OF SPEEDS	RPM@ FREE AIR	AMPS@ FREE AIR	BRNG.
	0.1	0.2	0.3	0.4	0.5	0.6	0.7	0.8	0.9	1.0							
A069	72	67	63	60	53	52	50	43	40	—	69	208-230	60	1	3000	0.45	SLV
B23617	72	67	64	62	57	55	50	46	41	33	70	115/230	60	1	3000	.9/.45	SLV
B23618	72	67	64	62	57	55	50	46	41	33	70	115/208-230	60	1	3000	.95/.45	BALL
A071	70	67	63	58	57	55	51	35	—	—	71	115	60	1	2850	0.7	SLV
A073	72	69	67	63	61	57	53	48	43	37	73	115 - 230	50/60	1	3200	.77.35	BALL
B75	68	63	57	47	34	14	—	—	—	—	75	115	60	1	3200	0.59	SLV
A075	73	69	65	62	58	55	50	45	40	35	75	230	60	1	3200	0.4	BALL
A082	66	62	53	52	47	42	23	—	—	—	75	115	60	1	2800	0.95	SLV



A069

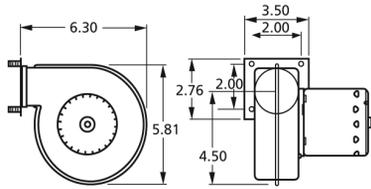

B23617

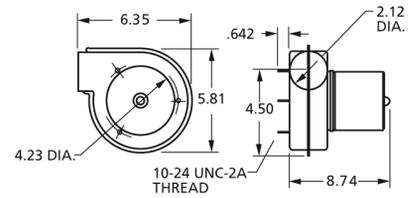

A071

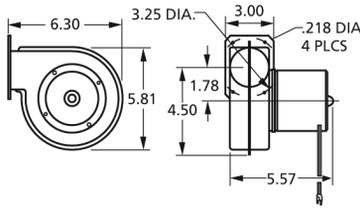

A073

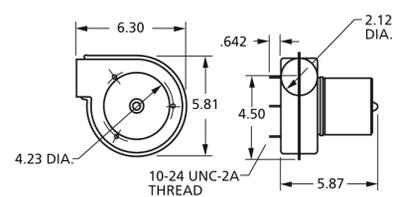

B75

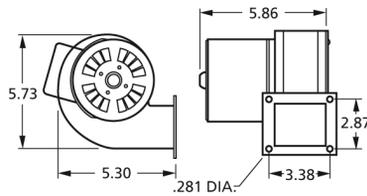

A075

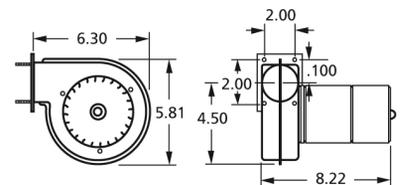

A082

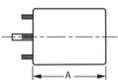
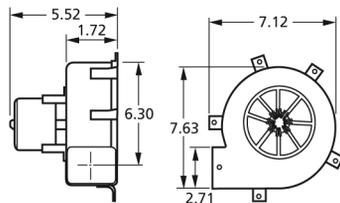

Thermally protected • UL recognized • CSA or ULc certified
NOTE: Rotation is determined by looking at shaft end. Shaft length is measured from motor face.

Centrifugal Blowers

80 to 125 Free Air Output



MODEL	CFM AT STATIC PRESSURE SHOWN										NAMEPLATE CFM	VOLTS	FREQ.	NO. OF SPEEDS	RPM@ FREE AIR	AMPS@ FREE AIR	BRNG.
	0.1	0.2	0.3	0.4	0.5	0.6	0.7	0.8	0.9	1.0							
A081	70	67	64	62	57	53	48	42	-	-	80	230	60	1	3100	0.45	BALL
A083	71	68	66	63	59	54	47	43	37	-	83	230	60	1	3000	0.8	BALL
50757-D500	80	63	45	-	-	-	-	-	-	-	105	115	60	1	1560	0.55	SLV
A166	110	100	95	85	82	60	40	10	-	-	115	115	50/60	1	3200	1.4	SLV
50746-D500	94	87	77	67	48	18	-	-	-	-	120	115	60	1	3100	0.72	SLV
A125	110	92	71	-	-	-	-	-	-	-	125	115	60	1	3200	1.1	SLV



A081

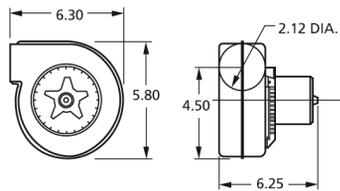

A083

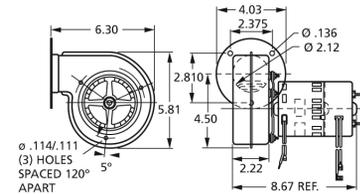

50757-D500

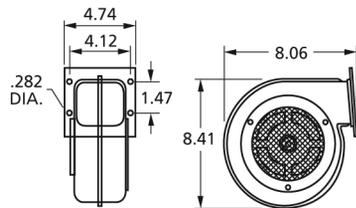

A166

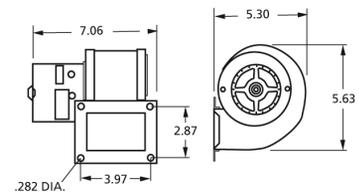

50746-D500

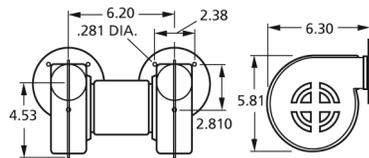

A125

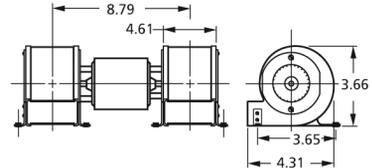



80 to 125 Free Air Output

Centrifugal Blowers

MODEL	CFM AT STATIC PRESSURE SHOWN										NAME-PLATE CFM	VOLTS	FREQ.	NO. OF SPEEDS	RPM@ FREE AIR	AMPS@	
	STATIC PRESSURE (INCHES OF WATER)															FREE AIR	BRNG.
	0.1	0.2	0.3	0.4	0.5	0.6	0.7	0.8	0.9	1.0							
50752-D500	108	105	97	93	90	83	77	65	32	-	135	115	60	1	3100	1.1	SLV
50752-D230	108	105	97	93	90	83	77	65	32	-	135	208-230	50/60	1	3100	0.67	SLV
B160	135	130	115	100	75	20	-	-	-	-	150	115	60	1	3000	1.56	SLV
A159	140	138	118	105	-	-	-	-	-	-	159	230	60	1	1600	0.45	BALL
50755-D500	140	128	118	105	-	-	-	-	-	-	160	115	60	1	1600	1	SLV
50755-D230	140	128	118	105	-	-	-	-	-	-	160	208-230	50/60	1	1600	0.51	SLV
A161	140	138	118	105	-	-	-	-	-	-	161	230	60	1	1600	0.55	BALL
B47120	180/144/112	170/140/109	165/134/106	165/130/100	150/122/90	140/117/76	130/87/58	110/72	90	-	180	115	60	3	1360/1100/830	1.95	SLV
A212	190	173	142	110	70	22	-	-	-	-	212	115	60	1	2500	1.25	SLV
B45227	230	212	191	175	130	27	-	-	-	-	265	115	60	1	1650	1.86	SLV
B45227-2	230	212	191	175	130	27	-	-	-	-	265	230	50/60	1	1650	0.93	SLV



50752-D500,
50752-D230

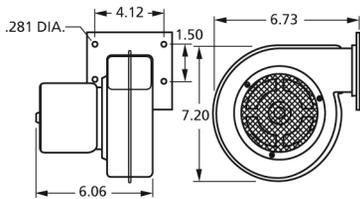

A159

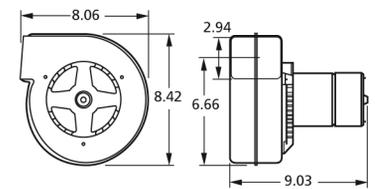

50755-D500,
50755-D230

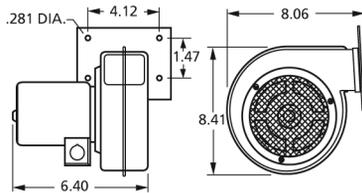

A161

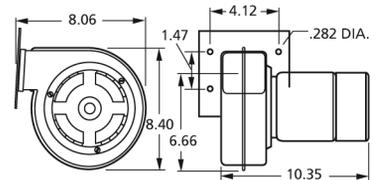

B47120

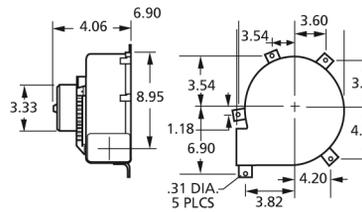

A212

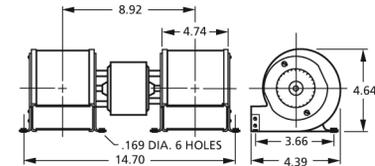

B45227,
B45227-2

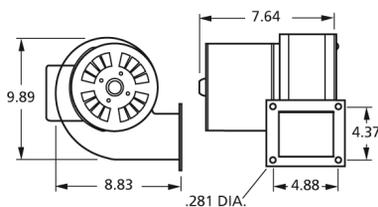

B160

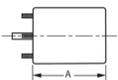

NEW ITEM! See page 113 for a complete listing of all our new products.

Thermally protected • UL recognized • CSA or ULc certified

NOTE: Rotation is determined by looking at shaft end. Shaft length is measured from motor face.

Centrifugal Blowers

320 to 1000 Free Air Output



MODEL	CFM AT STATIC PRESSURE SHOWN										NAMEPLATE CFM	VOLTS	FREQ.	NO. OF SPEEDS	RPM@ FREE AIR	AMPS@ FREE		BRNG
	0.1	0.2	0.3	0.4	0.5	0.6	0.7	0.8	0.9	1.0						AIR	AIR	
50756-D500	245	225	200	160	-	-	-	-	-	-	320	115	60	1	1500	1.3	SLV	
50756-D230	245	225	200	160	-	-	-	-	-	-	320	230	50/60	1	1500	0.65	SLV	
A455	440/318	417/307	390/290	375/275	350/250	319/228	275/170	231/108	150/75	68/40	455	115	60	2	1500/1100	1.5	SLV	
B45267	393/356	359/331	318/297	254/240	187/167	64/58	-	-	-	-	460	115	60	2	1600/1400	2.9	SLV	
B45230	393/356	359/331	318/297	254/240	187/167	64/58	-	-	-	-	460	208-230	50/60	2	1600/1400	1.2	SLV	
50769-D500	391/331	370/315	349/280	318/273	292/241	250/203	204/138	91/70	47/40	-	480	115	60	2	1200/1400	3.55	SLV	
50769-D230	391/331	370/316	349/281	318/274	292/242	250/204	204/139	91/71	47/41	-	480	208-230	50/60	2	1200/1400	1.9	SLV	
B68042	694	674	652	585	557	483	127	51	-	-	815	115	60	1	1100	5.6	SLV	
A1000	950/-	920/-	880/-	850/799	800/750	730/700	660/640	580/500	300/260	120/120	1000	115/230	60	2	1100/1100	4-2.9/2-1.4	SLV	

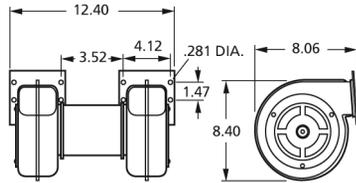

50756-D500,
50756-D230

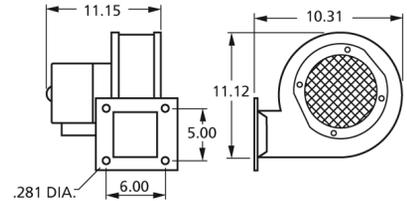

A455

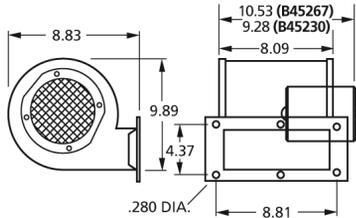

B45267,
B45230

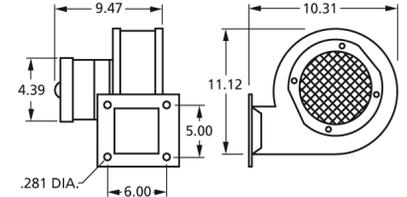

50769-D500,
50769-D230

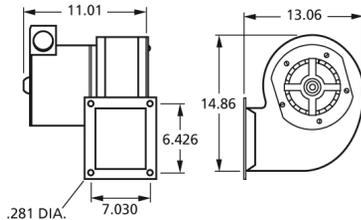

B68042

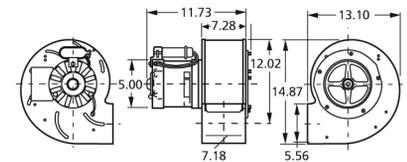

A1000



MODEL	CFM AT STATIC PRESSURE SHOWN STATIC PRESSURE (INCHES OF WATER)										NAMEPLATE CFM	VOLTS	FREQ.	NO. OF SPEEDS	RPM@ FREE AIR	AMPS@ FREE AIR	BRNG
	0.1	0.2	0.3	0.4	0.5	0.6	0.7	0.8	0.9	1.0							
B22505	57	22	-	-	-	-	-	-	-	-	80	115	50/60	1	3200	0.55	SLV
B22507	90	40	-	-	-	-	-	-	-	-	115	115	50/60	1	3100	0.85	SLV
B22508	100	60	5	-	-	-	-	-	-	-	105	115	60	1	1500	0.7	SLV
B22510	125	83	-	-	-	-	-	-	-	-	150	115	50/60	1	3100	1	SLV
B22515	145	125	50	-	-	-	-	-	-	-	150	115	60	1	2200	0.81	SLV
B22513	196	70	-	-	-	-	-	-	-	-	215	115	60	1	2780	1.3	SLV



B22505

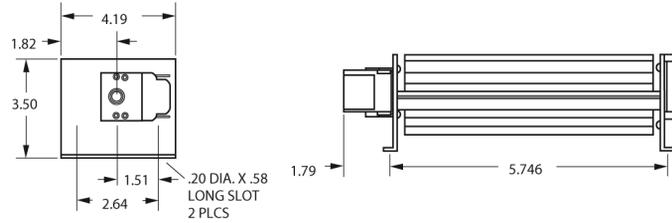

B22507

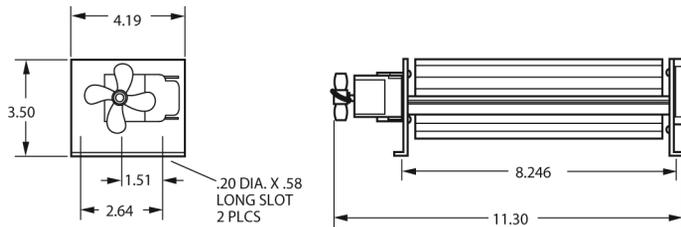

B22508

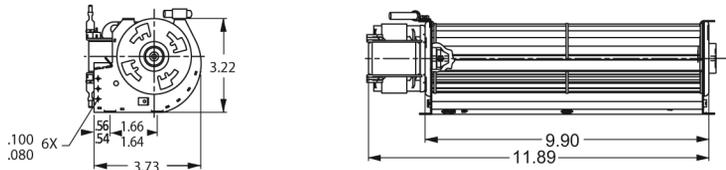

B22510

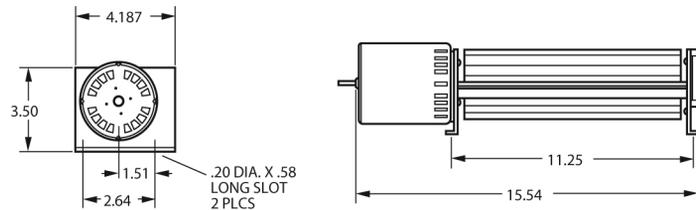

B22515

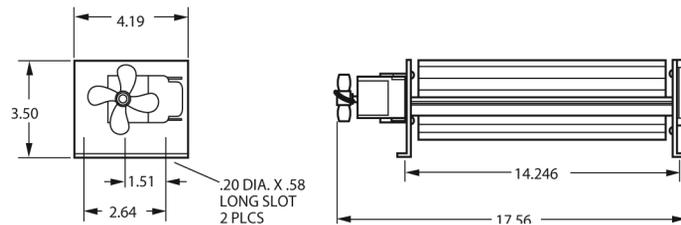

B22513

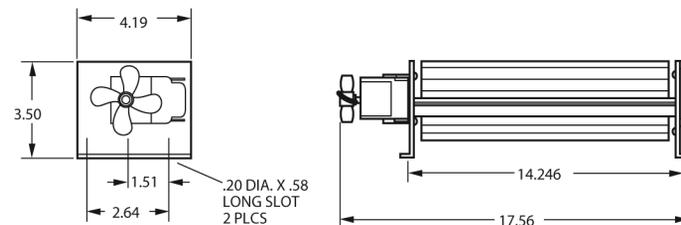



FASCO MODEL	TYPE	DIA.	HP	VOLTS	RPM	SPD.	AMPS	ROT.	BRING.	CROSS REF.	FIG.	NOTES
AMERICAN WATER HEATER												
W1	SP	3.3	1/25	115	3210	1	1.9	CW	SLV	7021-10060, 3000288	A	
AO SMITH												
W2	SP	3.3	1/14	115	3275	1	2.3	CW	BALL	7021-10770, 183505-000	B	
W4	SP	3.3	1/20	115	3300	1	1.8	CCW	SLV	7021-10910, 183381-000	C	
BRADFORD WHITE												
W3	SP	3.3	1/17	115	3000	1	1.8	CCW	SLV	117524-00, 239-39785-00	D	
W5	SP	3.3	1/14	115	3275	1	2.5	CW	BALL	7021-10712, 239-42133-00B	E	
W6	SP	3.3	1/15	115	3000	1	2.2	CCW	SLV	7021-9764, 239-4061 4-00C	F	
GSW												
W7	SP	3.3	1/25	115	3200	1	1.3	CW	SLV	7021-8347, 63217	G	
W8	SP	3.3	1/25	115	3200	1	1.3	CW	SLV	7021-9756, 63172	H	
STATE IND.												
W9	SP	3.3	1/60	115	3000	1	0.95	CW	SLV	7021-10548, 0012400500	I	
W10	SP	3.3	1/20	115	3400	1	1.8	CCW	SLV	7021-11086, 0012400540	J	



FIG. A W1



FIG. B W2



FIG. C W4



FIG. D W3



FIG. E W5



FIG. F W6



FIG. G W7



FIG. H W8



FIG. I W9



FIG. J W10



Thermally protected • UL recognized • CSA or ULc certified
NOTE: Rotation is determined by looking at shaft end. Shaft length is measured from motor face.



FASCO MODEL	TYPE	DIA.	HP	VOLTS	RPM	SPD.	AMPS	ROT.	BRNG.	SHAFT DIM.	"A" DIM.	CROSS REF.	FIG.	NOTES
AIR AMERICA CORP.														
▶ D1028	SP	5	1/8	115	1050	1	3.3	CW	BALL	1/2 X 2 1/2	3 1/2	A0510B2008	A	
AIR PLUS														
A087	PSC	3.3	1/6	115/230	2400	1	2.8/1.1	CCW	SLV			7062-4687	B	195
ALADDIN STEEL														
A120	SP	-	1/40	120	3000	2	1.1	CW OLE	BALL			230-1460, 7002-2983	C	
AMANA														
D1062	PSC	5	1/20 - 1/30 - 1/40	265	1100	3	.4-.3-.2	CW	SLV	1/2 X 3 1/2	3 3/4	Amana C-6397902 Emerson K48HXCNB-1458 5KCP29FK5258S	D	1
D1056	PSC	5	1/20 - 1/30 - 1/40	208-230	1100	3	.4-.3-.2	CW	SLV	1/2 X 3	3 5/8	Amana 900 Unit C61147-5 5KCP29FK886S	E	1, 18
D1058	PSC	5	1/20 - 1/30 - 1/40	265	1100	3	.5-.3-.2	CW	SLV	1/2 X 2 1/2	3 5/8	5KCP29FK885S Amana C-61147-6	F	
A129	SP	3.3	1/20	115	3250	1	1.95	CW	SLV			Amana, 7021-9064 7021-9259	G	
A158	PSC	3.3	1/25	115	1550	1	0.7	CW	SLV			7062-3151	H	
A160	SP	3.3	1/30	115	3000	1	1.6	CW	SLV			Amana, 7002-2407	I	
A180	SP	3.3	1/30	115	3400	1	1.8	CCW	BALL			7021-9625, 20190601	J	
A185	SP	3.3	1/30	115	3000	1	1.15	CW	SLV			7021-9316, 105854-04	K	
A280	SP	3.3	1/25	115	3000	1	1.5	CW	SLV			7021-7794, D986868	L	
A283	SP	3.3	1/25	115	3000	1	1.5	CCW	SLV			7021-8730, D9868617	L	
A286	SP	3.3	1/35	208/230	3125	1	0.6	CW	SLV			7021-9398, 11096904	K	
A287	SP	3.3	1/25	115	3000	1	1.15	CW	SLV			7021-9655, 10585405	K	
A289	SP	-	1/32	208/230	3125	1	0.75	CW	BALL			7058-0081, 20351402	M	
AMERICAN AIR FILTER														
▶ D1065	PSC	5	1/6	277	1600	1	0.9	CCW	SLV	1/2 X 2 1/2	3 1/3	ZCAABBWY15141, IWCQ5827 5KCP29DK3697T	N	1
▶ D827	PSC	5.6	1/8	115	700	1	2.5	CCW	BALL	1/2 X 2	5 1/2	7-150444-02	O	3

NOTES: 1: 4M 370V capacitor 3: 6M 370V capacitor 18: Rotation is determined by viewing lug end. 195: 50/60 Hz



FIG. A D1028



FIG. B A087



FIG. C A120



FIG. D D1062



FIG. E D1056



FIG. F D1058



FIG. G A129



FIG. H A158



FIG. I A160



FIG. J A180



FIG. K A185, A286, A287



FIG. L A280, A283



FIG. M A289



FIG. N D1065



FIG. O D827

FASCO MODEL	TYPE	DIA.	HP	VOLTS	RPM	SPD.	AMPS	ROT.	BRNG.	SHAFT DIM.	"A" DIM.	CROSS REF.	FIG.	NOTES
APRILAIRE														
D1110	SP	3.3	1/55	115	1300	1	.7	CW	BALL	1/4 X 1 7/8	3 5/8	7163-8633, 10002351	A	
D1114	SP	3.3	1/11	115	1250	1	.5	CW	SLV	1/4 X 3 1/8	2 1/2	7163-7448, 33110076	B	
ARKLA														
D795	PSC	5.6	1/3	115	825	1	6.1	REV	BALL	1/2 X 6	5 3/4	Gas Heat Pump, K55HXSFN8042	C	
ARMSTRONG														
A155	SP	3.3	1/30	115	3000	1	1.4	CCW	BALL			7021-10046	D	
BOHN														
D1124	SP	3.3	1/20	115	1550	1	2.1	CW	SLV	5/16 X 3	3	5KSM59JSK143S & 5KSM59JS5036S	E	75
D1126	SP	3.3	1/15	208-230	1550	1	1.1	CW	SLV	5/16 X 3	3 1/2	5KSM59LS2262AS	E	75
D1125	PSC	3.3	1/12	208-230	1550	1	0.5	CCW	SLV	5/16 X 2 5/8	3 3/4	7190-0442	F	29
BROAN														
K610	SP	-	1/60	115	3000	2	.88-.68	CCW	SLV	.217 X 1.3		Motor 30080011, Model Y2-52000	G	
K612	SP	-	1/65	115	3000	1	0.8	CW	SLV	.25 X 2.7		Model 162 (Before 1980)	H	
K611	SP	-	1/100	115	3000	1	0.67	CCW	SLV	.25 X 2.45		Model 162 (After 1980)	I	
D1087	SP	5	1/12	115	1050	1	2.9	CW	SLV	1/2 X 2 1/3	2 5/8	99-08-0178, 7151-3160	J	
K110	SP	-	1/75	115	3000	1	0.9	CCW	SLV	.217 X 2.37		99-08-0165, 670A	K	
BRYANT/CARRIER														
D803	PSC	5.6	1/3 - 1/4	230	1075	2	2.6-2.2	REV	SLV	1/2 X 3 1/2	4 1/2	K55HXLKK-5918, HC41VB701	L	
D1179	SP	3.3	1/30	115	3000	1	1.5	CW	SLV	5/16 X 2	3 1/2	BDP P251-2916 FRANKLIN 8251510360	M	
D1180	SP	3.3	1/20	115	3300	1	1.9	CW	SLV	5/16 X 2 1/8	3 5/8	Carrier HC27UE120, BDP 398A, BDP P251-2307 U.E. JAIP053N, UE Stock 580	M	

NOTES: 29: 4M 370V capacitor included 75: Shell Turbo 68, low temp. oil (-40°F)



FIG. A D1110



FIG. B D1114



FIG. C D795



FIG. D A155



FIG. E D1124, D1126



FIG. F D1125



FIG. G K610



FIG. H K612



FIG. I K611



FIG. J D1087



FIG. K K110



FIG. L D803



FIG. M D1179, D1180



Thermally protected • UL recognized • CSA or ULc certified
NOTE: Rotation is determined by looking at shaft end. Shaft length is measured from motor face.



FASCO MODEL	TYPE	DIA.	HP	VOLTS	RPM	SPD.	AMPS	ROT.	BRNG.	SHAFT DIM.	"A" DIM.	CROSS REF.	FIG.	NOTES
BRYANT/PAYNE														
D847	PSC	5.6	1/8	208-230	1125	1	0.9	CCW	SLV	1/2 X 3 1/2	3 3/4	K1543, HC35VE-230 KA55CGD-9658	A	
BUCK STOVE														
D1138	SP	3.3	1/50 - 1/80 - 1/140	115	1500	3	.9-6-.5	CW	SLV	5/16 X 2 1/2	4	R22CCW270ZD 7163-6045	B	
D1139	SP	3.3	1/50 - 1/80 - 1/125	115	1500	3	0.88	CW	SLV	2 1/2 X 5/16 X 1 1/8	2 13/16	R22CW206MD	C	
BUTLER VENTILATOR														
D1066	SP	5	1/10	115	1050	1	3.6	CW	BALL	1/2 X 2 3/4	3 7/8	846PY4V, 2414	D	
CAMCO														
D1119	SP	3.3	1/90	240	1500	1	0.34	CCW	SLV	1/4 X 1 1/2	2 1/4	Universal JBIP04410V Electrohome 2868- 405-173, Rotom R302	E	
CARRIER														
D455	SP	3.3	1/30	115/230	3000	1	1.3-.7	CCW	BALL	1/4 X 3 7/8	5 7/8		F	7, 196
D456	SP	3.3	1/15	115/230	3000	1	2-1	CW	BALL	1/4 X 2 3/4	6 1/2		G	7, 196
D457	SP	3.3	1/15	115/230	3000	1	2-1	CCW	BALL	1/4 X 2 3/4	6 1/2		G	7, 196
D458	SP	3.3	1/15	208-230	3000	1	1	CW	BALL	1/4 X 2 3/4	6 1/2		G	7, 196
D1174	SP	3.3	1/15	460	3000	1	0.6	CW	BALL	1/4 X 2 1/2	6 3/4	Carrier HC34AU725A Universal JB1P044NV HC24AU725	G	8
D1178	PSC	3.3	1/15	208-230	3450	1	0.45	CW	BALL	1/4 X 2 3/4	6 3/4	Carrier HC680001, Fasco 7162-3829	H	

NOTES: 7: Includes shaft bushing 8: Does not have shaft bushing 196: Draft Booster/ Flue Exhaust/ Switch Motors



FIG. A D847



FIG. B D1138



FIG. C D1139



FIG. D D1066



FIG. E D1119



FIG. F D455



FIG. G D456, D457, D458,
D1174



FIG. H D1178



FASCO MODEL	TYPE	DIA.	HP	VOLTS	RPM	SPD.	AMPS	ROT.	BRNG.	SHAFT DIM.	"A" DIM.	CROSS REF.	FIG.	NOTES
CARRIER (CONT.)														
D864	PSC	5.6	1/6 - 1/8 - 1/10	208-230	1040	3	1.3-1.2-1.1	CW	SLV	2 1/8 X 1/2 X 7 1/4	3 3/4	124279, 128560, 124276, 7126-0103, 7126-0043	A	
D842	PSC	5.6	1/5	230	1075	1	1.3	CW	SLV	1/2 X 3 X 1/4	3 3/4	HC37VE230 Cond. Round unit	B	1
D848	PSC	5.6	1/5 - 1/6 - 1/8	265-277	1040	3	1.1-8-.7	CW	SLV	3 X 1/2 X 7	3 1/2	51PH124275 HC37MB-730	A	
D463	SP	3.3	1/30	208-230	3000	1	0.65	CW	BALL	5/16 X 2 1/2	3 7/8	HC24HE230	C	
D1182	PSC	3.3	1/16	208-230	3450	1	0.57	CCW	SLV	5/16 X 3 1/3	4 1/2	7162-3367 HC30GB230B K33HXCCP-915 HC30GB230	D	
D459	SP	3.3	1/15	230/460	3000	1	1.2-.6	CW	BALL	1/4 X 3	7	HC24AU725A, JB1P044 AB1S078, JB1R039 AB1S029	E	
D844	PSC	5.6	1/4	230	1625	1	1.5	CW	SLV	1/2 X 3	3 1/2	HC37ME268 5KCP39BG7524S	F	1
D843	PSC	5.6	1/4 - 1/5	208-230	1075	1	2.2-2	REV	SLV	1/2 X 4 1/4	4	F48SG6MA10, F48SG6MA16 F48SG6MA28, F48SG6MA37 F48SJ6MA28, HC37MZ220, HC39VE608, HC39ML706, HC39ME720	G	
D802	PSC	5.6	1/2	460	1050	1	0.9	REV	BALL	1/2 X 3 1/3	5 1/2	Carrier HC44VL463A AO Smith FEH1056S GE 5KCP39PGH600CS	H	
S2846	PSC	5.6	1/2	230/460	1075	1	3.9-2	REV	BALL	1/2 X 5 3/8	6 1/2	Canopy Type Outdoor Condenser Fan Motor	I	
D838	PSC	5.6	3/4 - 1/2 - 1/3 - 1/4	115	1075	4	11.2-9.7-7.5-6.4	REV	SLV	1/2 X 6 1/2	5 1/4	HC45SE116, SC435X101, HC43SE116	J	
S2848	PSC	5.6	3/4	230/460	1075	1	4.7-2.4	REV	BALL	1/2 X 6	7 3/4	Canopy Type Outdoor Condenser Fan Motor	K	

NOTES: 1: 4M 370V capacitor



FIG. A D864, D848



FIG. B D842



FIG. C D463



FIG. D D1182



FIG. E D459



FIG. F D844



FIG. G D843



FIG. H D802



FIG. I S2846



FIG. J D838



FIG. K S2848



Thermally protected • UL recognized • CSA or ULc certified
NOTE: Rotation is determined by looking at shaft end. Shaft length is measured from motor face.

NEW ITEM! See page 113 for a complete listing of all our new products.



FASCO MODEL	TYPE	DIA.	HP	VOLTS	RPM	SPD.	AMPS	ROT.	BRNG.	SHAFT DIM.	"A" DIM.	CROSS REF.	FIG.	NOTES
CARRIER/WHIRLPOOL														
D1176	PSC	3.3	1/15 - 1/25	115	1550	2	.9-.8	DS	SLV	4 7/8 X 3/8 X 4 7/8	4	130096, 202466	A	1
CHAMPION COOLER														
D1069	SP	5	1/10 - 1/15	115	1040	2	3.5-2.2	DS	SLV	3 X 3/8 X 3	2 5/8	7151-2925, 7151-0109, MP2500	B	
CHROMALOX														
D1118	SP	3.3	1/30	240	1500	1	0.6	CW	BALL	5/16 X 3 1/2	2 13/16	2868-811-005B, 2868-505-016, 2686-511-027A	C	
CHRYSLER AIRTEMP														
D1022	PSC	5	1/5 - 1/6 - 1/8	208-230	1100	3	1.6-1 .1-1	CW	SLV	2 3/8 X 1/2 X 2 3/4	3 7/8	3704387, 2874493, 2874495	D	16
COLEMAN														
A088	SP	3.3	1/25	115	3200	1	1.3	CW	SLV			7021-5478	E	
COLEMAN														
D178	SP	5	1/8 - 1/11	115	1050	2	4.5-3.4	CW	SLV	1/2 X 4	3 1/4	Blower Motor	F	
D408	SP	3.3	1/150	115	3000	1	0.5	CW	SLV	1/4 X 1 1/2	5 1/2	7995-316, 7121-5906	G	
CONSOLIDATED INDUSTRIES														
A128	SP	3.3	1/50	120	3000	1	0.9	CW	SLV			7021-6376, 7021-9404	H	
COPELAND														
D783	PSC	5.6	1/4	208-230	1625	1	1.5	REV	SLV	1/2 X 6	4	3047, 050-0238-00	I	
DUOTHERM														
D1080	SP	5	1/6	115	1050	1	7.9	CW	BALL	1/2 X 4	4 1/2	3-14826; 100,000 BTU Furnaces	J	
D1081	PSC	5	1/6 - 1/8 - 1/10	115	1625	3	2.4-1.9- 1.5	REV	SLV	3 1/2 X 1/2 X 3 5/8	4 7/8	3-9650; 12,000 - 13,000 BTU's 5KCP29MG40115 8743810260, 3-18440	K	12
D1001	SP	5	1/15	115	1000	1	3.2	CW	SLV	3/8 X 3 1/4	2 1/3	3-9930	L	

NOTES: 1: 4M 370V capacitor 12: 10M 370V Capacitor 16: Rotation is determined by viewing lug end



FIG. A D1176



FIG. B D1069



FIG. C D1118



FIG. D D1022



FIG. E A088



FIG. F D178



FIG. G D408



FIG. H A128



FIG. I D783



FIG. J D1080



FIG. K D1081



FIG. L D1001



FASCO MODEL	TYPE	DIA.	HP	VOLTS	RPM	SPD.	AMPS	ROT.	BRNG.	SHAFT DIM.	"A" DIM.	CROSS REF.	FIG.	NOTES
ECONOMITE/MID-CONTINENT GAS BURNER														
D1151	SP	3.3	1/40	115	1500	1	1.2	CCW	SLV	5/16 X 3 1/4	2 3/4	AA2P026N	A	
EMERSON														
D1033	PSC	5	1/5 - 1/6 - 1/8	208-230	1400	3	1.6-1.5-1.3	DS	SLV	2 3/4 X 1/2 X 3 1/2	3 3/4	Quiet Cool	B	
EVANS/ARMSTRONG/LSI/HOME														
D825	PSC	5.6	1 - 3/4	230	1625	2	6.2 - 5.6	REV	SLV	1/2 X 3	6 3/4	5KCP35SG6445	C	12
EVCON														
K629	SP	-	1/85	115	2950	1	0.67	CW	SLV	1/4 X 1 1/8		7102-2187	D	
A156	SP	3.3	1/35	115	3000	1	1.1	CW	SLV			Evcon, 7021-8935	E	
EXCEL COMFORT														
A100	SP	-	1/45	115	2900	1	1.21	CW	SLV			7058-0280, 20093603/B	F	
FASCO														
K102	SP	-	1/200	115	3000	1	0.64	CW	SLV	.181 X 1.5		Model 2435	G	
K100	SP	-	1/100	115	3000	1	0.71	CW	SLV	.181 X 1.11		0648-0027 Ventilator	H	
K101	SP	-	1/150	230	3000	1	0.58	CCW	SLV	.217 X 1.34		Model 2540; 7102-0001 Motor	I	
D1159	SP	3.3	1/130	115	1500	1	0.45	CCW	SLV	5/16 X 1 1/8	2 1/8	7163-1845, VENT 656, VENT 293A, VENT PV7896	J	
D1160	SP	3.3	1/100	115	1480	1	0.58	CW	SLV	5/16 X 1 1/2	2 1/8	7163-2593, 663, 668, 763, 768, 661, 761	J	
D1162	SP	3.3	1/100	115	1500	1	0.6	REV	SLV	5/16 X 1	3 1/2	7163-9809 7163-1541, Model 659 Vent	K	
D1161	SP	3.3	1/15 - 1/25	115	1600	2	2.9-2	CCW	SLV	5/16 X 2	4 1/4	Several Blower Applications	L	
D824	PSC	5.6	1/4 - 1/8	115	1100	2	3.2-2.4	REV	BALL	1/2 X 3 1/2	5 3/4	Pedestal Fan 7126-0922, 7126-2594, 7126-0485, 7126-0936	M	
D820	PSC	5.6	1/3 - 1/4	120	1050	2	4.8-4.5	REV	SLV	1/2 X 2	4 1/4	Whole house fans 7126-1194, 7126-0545, 7126-0158 7126-0460, 7126-1195	N	

NOTES: 12: 10M 370V Capacitor



FIG. A D1151



FIG. B D1033



FIG. C D825



FIG. D K629



FIG. E A156



FIG. F A100



FIG. G K102



FIG. H K100



FIG. I K101



FIG. J D1159, D1160



FIG. K D1162



FIG. L D1161



FIG. M D824



FIG. N D820

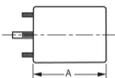

Thermally protected • UL recognized • CSA or ULc certified
NOTE: Rotation is determined by looking at shaft end. Shaft length is measured from motor face.

▶ NEW ITEM! See page 113 for a complete listing of all our new products.



FASCO MODEL	TYPE	DIA.	HP	VOLTS	RPM	SPD.	AMPS	ROT.	BRNG.	SHAFT DIM.	"A" DIM.	CROSS REF.	FIG.	NOTES
FEDDERS														
D441	SP	3.3	1/80	115	1500	1	0.6	CCW	SLV	1/4 X 1	2 1/8	Fedders, Oasis, Whirlpool Port Dehumidifiers	A	
D186	SP	3.3	1/20	460	1500	1	0.4	CW	SLV	5/16 X 2 1/3	2 7/8	Roof Top A/C	B	
D1012	SP	4.4	1/15 - 1/20 - 1/25	115	1550	3	2.3-1.9-1.6	DS	SLV	3 X 3/8 X 3	3 3/8	RMR, RY1302, 5206-00025-001 Y24CW50, 7190-0163	C	
D1010	SP	5	1/8 - 1/12 - 1/15	115	1050	3	4.4-3-2.3	DS	SLV	3 1/3 X 1/2 X 2 3/4	3 3/8	Window AC Motor; S196-20-2	D	
D1011	SP	5	1/6 - 1/12 - 1/15	208-230	1050	3	2.5-1.6-1.2	DS	SLV	3 1/3 X 1/2 X 2 3/4	3 1/4	Window AC Motors; S196-42-1, S296-161-3	D	
D884	PSC	5.6	1/6 - 1/8 - 1/10	115	1050	3	2.3-2-1.8	DS	SLV	5 X 1/2 X 4	3 3/4	S196-59-1, 2:72-1, 2:73-1, 2:74-1,2,3	E	
D882	PSC	5.6	1/5	230	1080	1	1.5	CW	SLV	1/2 X 4 1/4	3 1/2	Condenser Fan; S196-179-1	F	17
D1016	PSC	5	1/4	230	1100	1	2	CW	SLV	1/2 X 4 1/8	3 7/8	Condenser Fan; S196-18-2	G	
A159	SP	3.3	1/40	230	1550	1	0.5	CCW	BALL			AK4K84BX; 11-7096	H	
A161	SP	3.3	1/40	230	1600	1	0.6	CCW	BALL			Brinkley 8353920103; Fedders	I	
FRIEDRICH														
D868	PSC	5.6	1/3 - 1/4 - 1/5 - 1/6 - 1/7	230	1075	5	2.1-1.5-1.2-1-0.9	CCW	SLV	2 3/4 X 1/2 X 2 1/4	4 3/4	5KCP39MG90965, 5KCP39KGE9925 5KCP39LGD8045, 5KCP39LGG7205 5KCP39LGK010T, 5KCP39MG7145S 5KCP39MG9679S, 5KCP39LGM011T	J	18
FRYMASTER														
A110	SP	-	1/70	115	3212	1	0.76	CW	BALL			7021-0898	K	195
A111	SP	3.3	1/40	208-240	3200	1	0.8	CWLE	BALL			7021-11294, 8073637	L	

NOTES: 17: 7.5M 370V Cap installed 18: Rotation is determined by viewing lug end. 195: 50/60 Hz



FIG. A D441



FIG. B D186



FIG. C D1012



FIG. D D1010, D1011



FIG. E D884



FIG. F D882



FIG. G D1016



FIG. H A159



FIG. I A161



FIG. J D868



FIG. K A110



FIG. L A111



FASCO MODEL	TYPE	DIA.	HP	VOLTS	RPM	SPD.	AMPS	ROT.	BRNG.	SHAFT DIM.	"A" DIM.	CROSS REF.	FIG.	NOTES
GAFFERS AND SATTLER														
D862	PSC	5.6	1/2 - 1/3	208-230	1075	2	3.2-3	DS	SLV	2 5/8 X 1/2 X 2 1/2		Roof Top A/C Direct; Pak 1.5 & 2.0 EA	A	13
GENERAL ELECTRIC														
D896	PSC	5.6	1/5 - 1/8	208-230	1625	2	1.1-.7	CCWLE	SLV	2 7/8 X 1/2 X 2 1/4	3 3/4	KCP39DGD7795, WJ94X0518	B	1
D897	PSC	5.6	1/5 - 1/6 - 1/8 - 1/10	230	1075	4	1.5-1.1- 1-8	CW	SLV	2 3/8 X 1/2 X 2 1/2	3 3/4	KCP39EG5480S, 5KCP39DGK014T 5KCP39EG5480S, WP94X1, WJ94X162	C	1, 18
D894	PSC	5.6	1/6	277	1650	1	0.8	CW	SLV	1/2 X 2 1/4	3 3/4	5KCP39CGP7275	D	
D1050	PSC	5	1/8	230	1550	1	1.1	CW	SLV	1/2 X 3	3 1/4	A/C Condenser; KSP29DK1728S	E	202
D264	PSC	5	1/8	230	1550	1	1.1	REV	SLV	1/2 X 5	3 1/4	A/C Cond. Fan Motor	E	
D1086	PSC	5	1/12 - 1/25	277	1625	2	.6-.2	CCW	SLV	6 1/2 X 1/2 X 6 1/2	3 1/4	5KCP29CK3586AS	F	
D2850	PSC	5.6	1 - 3/4	208-230/460 60 HZ, 200/380-415 50 HZ	1125/950	1	4.6/2.3	CW	BALL	1/2 X 3.45	6 1/2	5KCP39SFL153DS (GE); MOT05717 Trane X70671180017, X70670706010, MOT03771, MOT05717	G	20
D2851	PSC	5.6	1 - 3/4	208-230/460 60 HZ, 200/380-415 50 HZ	1125/950	1	4.6/2.3	CW	BALL	5/8 X 3.75 Keyed	6 1/2	5KCP39SFL153DS (GE); MOT09188 MOT09188, MOT09192, Trane X7067165301 X70671656010	G	20
GIBSON-BELDING & KELVINATOR														
D1853	PSC	5.6	1/3 - 1/4 - 1/5	230	1090	3	2-1.9- 1.8	CW	SLV	6 X 1/2 X 2 7/8	4 1/4	G519243, G505976, K55HXNEC-6830	H	21
D854	PSC	5.6	1/3 - 1/4 - 1/6	208-230	1365	3	2.8-1.7- 1.2	CCW	SLV	4 1/2 X 1/2 X 2 5/8	4 1/2	Franklin X157668, X152275, 82181	I	9, 21
D855	PSC	5.6	1/3 - 1/4 - 1/5	230	1365	3	2.7-2- 1.7	DS	SLV	8 X 1/2 X 8 3/4	4 1/4	RAK7024	J	9
D856	PSC	5.6	1/3 - 1/4 - 1/5	230	1300	3	3.1	CW	SLV	5 1/4 X 1/2 X 3	5	G519244, G505971, K55HXNEM6844	K	21

NOTES: 1: 4M 370V capacitor 9: 3M 370V capacitor 13: 7.5M 370V Capacitor 18: Rotation is determined by viewing lug end. 20: Not a direct replacement, but suitable for referenced models. 21: Rotation is determined from viewing lug end 202: Original motor is SP, D1050 is PSC to provide greater motor efficiency and permit closing shaft end of motor to prevent moisture from entering motor.



FIG. A D862



FIG. B D896



FIG. C D897



FIG. D D894



FIG. E D1050, D264



FIG. F D1086



FIG. G D2850, D2851



FIG. H D1853



FIG. I D854



FIG. J D855



FIG. K D856



Thermally protected • UL recognized • CSA or ULc certified
NOTE: Rotation is determined by looking at shaft end. Shaft length is measured from motor face.



FASCO MODEL	TYPE	DIA.	HP	VOLTS	RPM	SPD.	AMPS	ROT.	BRNG.	CROSS REF.	FIG.	NOTES
GOODMAN												
▶ A065	SP	-	1/50	115	3000	1	1.22	CCW	BALL	0131M00002P, 119276-00	A	
A140	SP	3.3	1/50	115	3400	1	1.4	CW	SLV	7021-9087, 7021-9000	B	
A157	SP	-	1/35	115	3000	1	1.3	CCW	SLV	7002-2307	C	
A162	SP	3.3	1/50	208-230	3000	1	0.5	CCW	SLV	7021-8656	D	
A079	SP	3.3	1/50	115	3000	1	1.1	CCW	SLV	7021-6804	E	
A181	SP	3.3	1/30	115	3192	1	1.5	CW	BALL	7058-0136, 20044403	F	
A182	SP	3.3	1/35	115	3125	1	1.2	CCW	SLV	7002-3036, B4059000	G	
A184	SP	3.3	1/35	115	3125	1	1.55	CCW	BALL	7058-0229, B40590-01	H	
A187	SP	3.3	1/20	208-230	3250	1	0.8	CW	SLV	7021-10006, 20028901	I	
A188	SP	3.3	1/18	115	3250	1	1.6	CW	SLV	7021-10958, B4833000	J	
A189	SP	3.3	1/24	115	3000	1	1.5	CW	SLV	7021-7302, D9868620	K	
A281	SP	3.3	1/40	115	3000	1	0.9	CW	SLV	7021-8252, D6996405	L	
A282	SP	3.3	1/60	220	2600	1	0.45	CCW	SLV	7021-8448, B1859050S	M	
A284	SP	3.3	1/30	208/240	3000	1	.59/.5	CW	SLV	7021-9227, D98686202	L	
A285	SP	3.3	1/40	115	3250	2	1.4	CW	SLV	7021-9236, B2833002	B	
A288	SP	3.3	1/30	115	3100	2	1.4/.65	CW	BALL	7021-9727, 11177202	N	
A290	PSC	3.3	1/20	115	3200/2400	2	0.7	CCW	BALL	7062-5015, 20245903	O	



FIG. A A065



FIG. B A140, A285



FIG. C A157



FIG. D A162



FIG. E A079



FIG. F A181



FIG. G A182



FIG. H A184



FIG. I A187



FIG. J A188



FIG. K A189



FIG. L A281, A284



FIG. M A282



FIG. N A288



FIG. O A290



FASCO MODEL	TYPE	DIA.	HP	VOLTS	RPM	SPD.	AMPS	ROT.	BRNG.	SHAFT DIM.	"A" DIM.	CROSS REF.	FIG.	NOTES
GREENHECK FAN														
D1061	SP	4.4	1/20 - 1/30 - 1/60	115	1500	3	2-1.7-1.4	CCW	SLV	1/2 X 2 3/4		7108-2425	A	
HEAT N GLOW														
A133	SP	-	1/50	115	3000	1	1.2	CCW	SLV			7002-1241	B	
HEATCRAFT														
D1122	PSC	3.3	1/16	208-230	1650/1300	1	0.4	CW	SLV	5/16 X 1 5/8	3 5/8	7190-2255, 25308601	C	22
D1123	PSC	3.3	1/15	208-230	1550	1	0.5	CCW	SLV	5/16 X 2 5/8	3 7/8	7190-2285, 25309101	D	1
HEIL-QUAKER														
A064	SP	3.3	1/55	115	3150	1	0.7	CW	SLV			610172, 7021-5043	E	
D2810	PSC	5.6	1/6	208-230	1100	1	1	CCW	SLV	1/2 X 2		HQ 1050892EM, KA55HXHNC-2379	F	
D1071	PSC	5	1/6	208-230	1100	1	0.99	REV	SLV	1/2 X 2 1/8		HQ 1052662EM; 48HXCLW-1562	G	
A148	SP	3.3	1/50	208-230	3000	1	0.5	CCW	SLV			HEIL QUAKER, 7021-9237	H	
A151	SP	3.3	1/90	230	2800	1	0.3	CW	SLV			INTER CITY, HQ1050144	I	
HERMAN NELSON														
D829	PSC	5.6	1/4	115	825	1	3.8	REV	SLV	1/2 X 2	5 5/8		J	
D880	PSC	5.6	1/4	115	1050	1	4.3	CCW	BALL	1/2 X 1 1/2	5 1/2		K	
D827	PSC	5.6	1/8	115	700	1	2.5	CCW	BALL	1/2 X 2	5 1/2	7-150444-02	K	

NOTES: 1: 4M 370V capacitor 22: 2M 370V Capacitor



FIG. A D1061



FIG. B A133



FIG. C D1122



FIG. D D1123



FIG. E A064



FIG. F D2810



FIG. G D1071



FIG. H A148



FIG. I A151



FIG. J D829



FIG. K D880, D827



Thermally protected • UL recognized • CSA or ULc certified
NOTE: Rotation is determined by looking at shaft end. Shaft length is measured from motor face.

NEW ITEM! See page 113 for a complete listing of all our new products.



FASCO MODEL	TYPE	DIA.	HP	VOLTS	RPM	SPD.	AMPS	ROT.	BRNG.	SHAFT DIM.	"A" DIM.	CROSS REF.	FIG.	NOTES
HILL REFRIGERATION														
D801	PSC	5.6	1/3	208-230	1625	1	2.9	CCW	SLV	1/2 X 4	4 1/2	5KCP39KG1369S	A	
D800	PSC	5.6	1	208-230	1075	1	7.1-6.4	CW	BALL	1/2 X 3 3/4	5 1/4	PP19162G, 5KCP39GC030S 5KCP39PGC910S	B	24, 114
HONEYWELL AIR CLEANER														
D1054	SP	5	1/12 - 1/20 - 1/25	115	1050	3	3.1-2 .1-1.5	CW	SLV	1/2 X 2 1/2	2 5/8	190386A; 5KSP29DK1906S	C	
HUSSMAN														
D807	PSC	5.6	1/6	208-230	1625	1	1.2	CCW	BALL	1/2 X 4 7/8	3 3/4	5KCP39EGC244T, 5KSP39FG4771S	D	1
D890	PSC	5.6	1/2	208-230	1725	1	2.7	CCW	SLV	1/2 X 3 1/2	4 1/2	259983, K55HXCTP-9963	E	
K114	SP	-	1/500	115	3000	1	0.64	CCW	SLV	.181 X 1.75		301-5734	F	25
IEC														
D1040	PSC	5	1/5	208/240	925	3	1.6	CW	SLV	1/2 X 8	4 1/3	5KCP29KK8385S, S89209	G	197
D1041	PSC	5	1/15	265	1075	3	0.6	CW	SLV	1/2 X 7 1/8	3 7/8	5KCP29DK8389S, S89206	H	
D1043	PSC	5	1/4	265	1075	3	1.6	CW	SLV	1/2 X 6 1/4	4 5/8	5KCP29DK8386S, 289211	I	
D1044	PSC	5	1/4	115	970	3	6	CW	SLV	1/2 X 8	4 1/3	5KCP29DK8387S, S89210	G	
D1045	PSC	5	1/30	115-127	1100	3	0.53	CW	SLV	1/2 X 9	3 1/8	5KCP29BK8382S, S89202	J	29
D1047	PSC	5	1/20	208-230	1075	3	1.6	CW	SLV	1/2 X 7 1/8	3 7/8	5KCP29FK8028S, S88935	H	
D1048	PSC	5	1/20	277	1075	3	0.5	CW	SLV	1/2 X 7 1/4	3 7/8	5KCP29FK8132S, S89205	K	
D1049	PSC	5	1/20	265	1075	3	0.4	CW	SLV	1/2 X 7 1/8	3 7/8	5KCP29FK8388S, S89204	H	
D1053	PSC	5	1/30	265	1075	3	0.38	CW	SLV	1/2 X 7 1/8	3 1/3	5KCP29BK8094S, S89203	H	
D1055	PSC	5	1/12	115-127	1375	3	1.4	DS	SLV	9 1/8 X 1/2 X 9 1/2	3 1/8	5KCP29BK8383S, S89207	L	3
D1059	PSC	5	1/6	115-127	1450	3	2.3	DS	SLV	8 3/4 X 1/2 X 9	3 1/3	5KCP29DK8384S, S89208	L	31
ILG														
D115	SP	4.4	1/12	115/230	1550	1	2.5-1.3	CCW	SLV	1/2 X 2	4 1/8	78-27-721T; Fasco 7108-2237	M	
D1039	SP	4.4	1/10	115	1610	1	3.1	CCW	SLV	1/2 X 2 3/8	4 1/2	78-27-611N; Fasco 7108-2171	N	

NOTES: 1: 4M 370V capacitor 3: 6M 370V capacitor 24: 15M 370V Capacitor 25: Equipped with KFAN6046 fan blade 29: 4M 370V capacitor included 31: 5M 370V Capacitor 114: Separate connection for each voltage 197: For 208V use 7.5M 370V Capacitor and 240V use 6M 370V Capacitor



FIG. A D801



FIG. B D800



FIG. C D1054



FIG. D D807



FIG. E D890



FIG. F K114



FIG. G D1040, D1044



FIG. H D1041, D1047, D1049,
D1053



FIG. I D1043



FIG. J D1045



FIG. K D1048



FIG. L D1055, D1059



FIG. M D115



FIG. N D1039



FASCO MODEL	TYPE	DIA.	HP	VOLTS	RPM	SPD.	AMPS	ROT.	BRNG.	CROSS REF.	FIG.	NOTES
INTERCITY PRODUCTS												
D1167	SP	3.3	1/40	208-230	3000	1	0.55	CCW	SLV	1708-518, 7121-5854	A	
A051	SP	-	1/60	115	3000	1	1.6	CW	BALL	1013833, J238-1393	B	
A067	SP	3.3	1/20	115	3000	1	2.6	CW	BALL	1014338, 119225-00	C	
A134	SP	3.3	1/25	115	3060	1	1.5	CW	SLV	7021-9335, 7021-8735, 7021-9499, 7021-8736	D	
A145	PSC	3.3	1/25	115	3450	1	0.7	CCW	BALL	7062-4061	E	26
A141	SP	3.3	1/60	115	2800	1	1	CW	BALL	7021-8741, 7021-8742	F	
A148	SP	3.3	1/50	208-230	3000	1	0.5	CCW	SLV	7021-7617, 7021-9237	G	
A151	SP	3.3	1/90	230	2800	1	0.3	CW	SLV	HEIL QUAKER, HQ1050144	H	
A169	SP	3.3	1/25	230	2800	1	0.75	CW	SLV	7021-10048, 7021-10580	I	
A170	SP	3.3	1/25	115	3400	1	2.3	CCW	BALL	7021-10702, 7021-10299	J	
A171	PSC	3.3	1/25	115	3450	1	0.7	CCW	BALL	7062-4783, 1011412	K	
A172	SP	-	1/35	115	3000	1	1.6	CW	BALL	7002-2792, 1010975P	L	
A173	PSC	3.3	1/18	115	3450	1	0.8	CCW	BALL	7062-4578, 1011350	M	
A174	SP	3.3	1/100	115	2350	1	0.8	CW	SLV	7021-9188, 1010239	F	
A175	SP	-	1/40	115	3300	1	1	CCW	SLV	7002-1891, 1708-600P	N	

NOTES: 26: 4M 250V Capacitor included



FIG. A D1167



FIG. B A051



FIG. C A067



FIG. D A134



FIG. E A145



FIG. F A141, A174



FIG. G A148



FIG. H A151



FIG. I A169



FIG. J A170



FIG. K A171



FIG. L A172



FIG. M A173



FIG. N A175



Thermally protected • UL recognized • CSA or ULc certified
NOTE: Rotation is determined by looking at shaft end. Shaft length is measured from motor face.

NEW ITEM! See page 113 for a complete listing of all our new products.



FASCO MODEL	TYPE	DIA.	HP	VOLTS	RPM	SPD.	AMPS	ROT.	BRNG.	SHAFT DIM.	"A" DIM.	CROSS REF.	FIG.	NOTES
INTERCITY PRODUCTS														
A176	SP	-	1/25	115	3100	1	2.2	CW	BALL			7002-2946, 1011899, 7002-3071, 1011899P	A	
A177	SP	3.3	1/36	115	3000	2	1.4	CW	BALL			7021-10363, 1011632, 7021-10597, 1011632P	B	
A178	SP	3.3	1/30	115	3400	1	1.8	CW	BALL			7021-10928, 1013388FA	C	
A179	SP	3.3	1/60	115	3300	1	0.9	CW	SLV			7021-8693, 1006168P	D	
A301	SP	3.3	1/100	115	2350	1	0.8	CW	SLV			7021-9498, 1010239P	E	
A302	SP	3.3	1/25	115	3060	1	1.5	CW	SLV			7021-9499, 1010324P, 7021-7700, 1708-607	B	
A304	SP	3.3	1/25	115	3060	1	1.5	CW	SLV			7021-9701, 1011021	B	
A306	PSC	3.3	1/30	208-230	3350/2900	2	0.3	CCW	SLV			7062-4532, 1097245	F	195
A307	PSC	3.3	1/24	115	3450	1	0.7	CW	SLV			7062-5165, 1149097, 7062-3794, 1008416P	G	
INTERTHERM-ADDISON														
D872	PSC	5.6	3/4 - 1/2	230	1075	2	4.3-3.5	DS	SLV	2 X 1/2 X 6 1/4	5 1/2	5KCP39MGN341T	H	27
ITT REZNOR														
D404	PSC	3.3	1/10	208-230	3000	1	0.8	REV	BALL	5/16 X 3 1/4	4 1/4	CW175-40069, 7162-0293 CCW505-43424, 7162-0348 CCW175-40070, 7162-0294	I	29, 85
D405	PSC	3.3	1/10	115	3000	1	1.4	REV	BALL	5/16 X 3 1/4	4 1/4	CCW77162-0311 CCW175-43846 CW7162-0224, CW36860	I	29

NOTES: 27: 12.5M 370V Capacitor 29: 4M 370V capacitor included 85: Air Over 195: 50/60 Hz



FIG. A A176



FIG. B A177, A302, A304



FIG. C A178



FIG. D A179



FIG. E A301



FIG. F A306



FIG. G A307



FIG. H D872



FIG. I D404, D405



FASCO MODEL	TYPE	DIA.	HP	VOLTS	RPM	SPD.	AMPS	ROT.	BRNG.	SHAFT DIM.	"A" DIM.	CROSS REF.	FIG.	NOTES
JAKEL														
A072	SP	-	1/45	115	3000	1	1.15	CW	BALL			J238-1344	A	
JANITROL														
A073	SP	3.3	1/40	115-230	3000	1	.7/35	CCW	BALL			82932, 8251560133	B	
A079	SP	3.3	1/50	115	3000	1	1.1	CCW	SLV			7021-6804	C	
JENN AIR														
D1173	SP	3.3	1/30	115	1500	1	1.2	CW	BALL	5/16 X 2 1/2	3 7/8	70CR	D	
D1170	SP	4.4	1/15	115	1500	1	2.1	CW	BALL	3/8 X 2 1/2	4 3/4	80CR	E	
D377	SP	4.4	1/12	115	1500	1	3.1	CCW	SLV	3/8 X 2	2 3/4	7108-2101	F	
JOHNSON FURNACE														
A081	SP	3.3	1/40	230	3000	1	0.5	CCW	BALL		3 1/2	HWC Series Unit	G	
A085	SP	3.3	1/30	230	3000	1	0.7	CCW	BALL			AO Smith 464, Johnson Furnace	H	
KEEPRITE														
D1243	PSC	3.3	1/20	115	1550	1	0.8	CCW	SLV	5/16 X 2 3/4	4 1/8	501899, 7164-1243, 7164-1854, R370	I	29
D1245	PSC	3.3	1/20	208-230	1550	1	0.3	CCW	SLV	5/16 X 2 3/4	4	501909, 7164-1313, 7164-1853, R371	I	29
D1120	SP	3.3	1/20	115	1550	1	2.1	CW	SLV	5/16 X 2 1/2	3 1/2	7163-8722, 1043336	J	
D1121	SP	3.3	1/20	208-230	1550	1	1	CW	SLV	5/16 X 2 1/2	3 1/2	7163-8861, 1043766	J	
D1246	SP	4.4	1/15	115	1550	1	2.3	CCW	SLV	3/8 X 1 3/4	3 1/2	81356, 7108-2206	K	
KRACK REFRIGERATION														
D1158	SP	3.3	1/20	115/208-230	1550	1	1.4-.8	CW	BALL	5/16 X 1 5/8	3 5/16	Commercial Refrigeration Units	L	
D1189	SP	3.3	1/20	115/208-230	1550	1	1.4-.76	CW	BALL	5/16 X 1 5/8	3 1/8	11528, 11529, JB2P046N, JA2P216N, JA2P217N, JB2P047N, 8354110940, 8254111030	M	

NOTES: 29: 4M 370V capacitor included



FIG. A A072



FIG. B A073



FIG. C A079



FIG. D D1173



FIG. E D1170



FIG. F D377



FIG. G A081



FIG. H A085



FIG. I D1243, D1245



FIG. J D1120, D1121



FIG. K D1246



FIG. L D1158



FIG. M D1189



Thermally protected • UL recognized • CSA or ULc certified
NOTE: Rotation is determined by looking at shaft end. Shaft length is measured from motor face.

NEW ITEM! See page 113 for a complete listing of all our new products.



FASCO MODEL	TYPE	DIA.	HP	VOLTS	RPM	SPD.	AMPS	ROT.	BRNG.	SHAFT DIM.	"A" DIM.	CROSS REF.	FIG.	NOTES
KRAMER/TRENTON														
D1152	SP	3.3	1/20	115	1500	1	1.7	CW	SLV	5/16 X 2 3/8	2 7/8	5KSM59ES2001	A	
D1154	SP	3.3	1/20	230	1550	1	1	CW	SLV	5/16 X 2 3/8	3 1/8	JA2R140N	A	
D2862	PSC	5.6	1/2	208-230	1075	1	4	REV	BALL	1/2 X 3	6 1/2	5KCP37PN244BS, MTG3041	B	13
LARKIN COIL														
D1101	SP	3.3	1/20	115	1500	1	1.9	CCW	SLV	5/16 X 2 1/4	2 3/4	Larkin No. 253-1194 Fasco No. 7163-2113	A	75
D1103	SP	3.3	1/20	208-230	1500	1	1.15	CCW	SLV	5/16 X 2 1/4	3	Fasco No. 7163-3371, 252-1195	A	75, 201
D863	PSC	5.6	1/2	208-230	1075	1	4	REV	BALL	1/2 X 3	6 3/4	SCS0500HI-CPM120-3 5KCP39PGH728T	C	13
LEAR SIEGLER														
D1046	SP	5	1/8	115	1070	1	5.1	CW	SLV	1/2 X 2 1/4	3	305313-000-165, 7151-0073, 7151-2826	D	
LENNOX														
A068	SP	-	1/60	120	3000	1	1.15	CCW	BALL			88K8401, J238-8171	E	
A138	SP	3.3	1/70	120	3000	1	0.7	CCW	SLV			LENNOX, 7021-8657, 7021-8825	F	
A135	SP	3.3	1/60	120	3000	1	0.7	CCW	SLV			LENNOX, 7021-8812, 7021-8819	G	
A163	SP	3.3	1/20	115	3400	1	1.8	CCW	BALL			LENNOX, 7021-9450	H	
A164	SP	3.3	1/50	120	3400	1	0.8	CCW	SLV			LENNOX, 7021-9593	I	
A200	SP	-	1/30	115	3000	1	1.95	CCW	SLV			7002-2975, 31L5501	J	
A201	SP	3.3	1/30	208-230	3000	1	0.65	CCW	BALL			7021-10055, 41144-002	K	
A202	SP	3.3	1/30	115	3400	1	1.8	CCW	BALL			7021-10602, 45037-001	L	
A203	SP	3.3	1/20	115	3400	1	1.8	CCW	BALL			7021-10841, 49L5301	M	
A204	SP	3.3	1/20	115	3400	1	1.8	CCW	BALL			7021-11406, 83L4101	N	
A205	SP	3.3	1/20	120	3000	1	0.7	CCW	SLV			7021-8372, T6-2118	G	
A206	SP	3.3	1/25	115	3000	1	1.5	CW	SLV			7021-8473, 65204100/20J8901	O	

NOTES: 13: 7.5M 370V Capacitor 75: Shell Turbo 68, low temp. oil (-40°F) 201: Not a direct replacement for 253-1194, but is an acceptable substitute



FIG. A **D1152, D1154, D1101, D1103**



FIG. B **D2862**



FIG. C **D863**



FIG. D **D1046**



FIG. E **A068**



FIG. F **A138**



FIG. G **A135, A205**



FIG. H **A163**



FIG. I **A164**



FIG. J **A200**



FIG. K **A201**



FIG. L **A202**



FIG. M **A203**



FIG. N **A204**



FIG. O **A206**



FASCO MODEL	TYPE	DIA.	HP	VOLTS	RPM	SPD.	AMPS	ROT.	BRNG.	SHAFT DIM.	"A" DIM.	CROSS REF.	FIG.	NOTES
LENNOX														
A207	SP	-	1/28	115	3000	1	1.75	CCW	BALL			7058-0217, 60M7901	A	
A208	SP	-	1/28	115	3000	1	1.75	CCW	BALL			7058-0322, 60M8101	B	
A209	PSC	3.3	1/20	115	3200/2800	2	0.8	CCW	BALL			7062-5441, 38M5001	C	
A210	SP	3.3	1/30	115	3000	2	1.7	CCW	BALL			7021-11063, 18M6701	D	
A211	SP	3.3	1/15	115	3400	1	2.35	CCW	BALL			7021-11634, 81M1601	E	
A213	SP	3.3	1/25	115	3200	2	2.1	CCW	BALL			7021-10376, 18L0401	F	
A216	SP	3.3	1/25	115	3200	2	2.1	CCW	BALL			7021-10915, 60L1401	F	
A217	SP	3.3	1/16	230	3000	1	0.83	CCW	BALL			7021-11231, 25M5501	G	
A218	SP	3.3	1/28	220-240	3000	1	.60/.52	CCW	BALL			7021-10676, 39L4201, 7021-8959, 60J4201	H	
A219	SP	3.3	1/65	120	3000	1	0.7	CCW	SLV			7021-9262, 88J3901	I	
A320	SP	3.3	1/60	115	3000	1	.8	CCW	SLV			7021-9646, 101154-01, 7021-9466	I	
A322	SP	3.3	1/70	120	3000	2	1.1	CCW	SLV			7021-9884, 83L8201	J	
A324	PSC	3.3	1/12	230	3200	1	.44	CW	BALL			7062-1909, 28G6601, 7062-1794	K	
A325	PSC	3.3	1/10	208-230	3200	1	0.6	CW	BALL			7062-2845, 7062-4751, 98G8701	L	
A329	PSC	3.3	1/12	208-230	3200	1	0.5	CW	BALL			7062-4819, 19L1501	M	
A330	PSC	3.3	1/12	208-230	3200	1	0.55	CW	BALL			7062-5546, 7062-4517, 7062-4608, 7062-4083, 69M3301	N	
A331	PSC	3.3	1/10	460	3200	1	.38/.33	CW	BALL			7062-5554, 69M3201, 7062-4051, 7062-4518, 97J8101	N	
D1198	SP	3.3	1/30	115	3200	1	1.5	CCW	SLV	5/16 X 2 1/4	3 1/8	7121-8774	O	33

NOTES: 33: Stainless steel shaft



FIG. A A207



FIG. B A208



FIG. C A209



FIG. D A210



FIG. E A211



FIG. F A213, A216



FIG. G A217



FIG. H A218



FIG. I A219, A320



FIG. J A322



FIG. K A324



FIG. L A325



FIG. M A329



FIG. N A330, A331



FIG. O D1198



Thermally protected • UL recognized • CSA or ULc certified
NOTE: Rotation is determined by looking at shaft end. Shaft length is measured from motor face.



FASCO MODEL	TYPE	DIA.	HP	VOLTS	RPM	SPD.	AMPS	ROT.	BRNG.	SHAFT DIM.	"A" DIM.	CROSS REF.	FIG.	NOTES
LENNOX														
D812	PSC	5.6	1/3 - 1/4 - 1/6 - 1/8	115	1075	4	6.1-3.2-2.2-1.6	CW	SLV	1/2 X 3 1/8	4 1/4	P-8-7505	A	
D816	PSC	5.6	1/3	208-230	1075	1	2.2	CW	SLV	1/2 X 3 3/4	4	P-8-8041-A3048, 5KCP39HG0766T	B	
D818	PSC	5.6	1/3 - 1/5 - 1/6	115	825	3	7.3-5.1-3.9	CW	SLV	1/2 X 3	6 3/4	P-8-8325, 5KCP39-PGD698S	C	27
D2817	PSC	5.6	1/3	230	825	1	3.2	REV	SLV	1/2 X 6	5 3/4	5KCP39PG9701S, 5KCP39PG34P0AS	D	
D2814	PSC	5.6	1/2	230	1050	1	2.6	CW	BALL	1/2 X 3 1/4	5 3/4	P-8-5770	E	31
D813	PSC	5.6	3/4 - 1/2 - 1/3	230	1075	3	5.9-3-2.4	DS	SLV	5 1/4 X 5/8 X 6 1/2	6	31C8201, K55HXRYT-8180 K63BHXHW-1158, 5KCP49NG1009, 5KCP35SN49S, P-8-6426	F	12
D2818	PSC	5.6	3/4 - 1/3	230	1075	2	5-2.2	REV	BALL	5/8 X 4 1/2 Keyed	7 3/4	P-8-8711, 5KCP49SG1010S	G	24, 200
D2816	PSC	5.6	1 - 1/2 - 1/3	115	1075	3	11.8-6.3-3.9	REV	BALL	5/8 X 4	7 3/4	P-8-8326, 5KCP49SG1053S	G	15
LOMANCO														
D1008	SP	4.4	1/10	115	1500	1	4.4	CW	SLV	1/2 X 1 3/4	3	OLM6151, 322P151	H	
LOREN COOK														
D1100	SP	3.3	1/50	115	1550/900	2	1.2/7	CW	SLV	5/16 X 2 3/8	2 7/8	7173-1580, GC/GN 142/144	I	
D1104	SP	3.3	1/50	115	1550	1	.9	DS	SLV	2.9 X 5/16 X 2.9	3	7163-6714, 5-10	J	
D1117	SP	3.3	1/65	115	1590	1	0.6	CW	SLV	5/16 X 2 1/4	2 7/8	7163-7818, 615049, GC140	K	195
MAGIC CHEF														
D1091	PSC	5	1/4	208-230	1075	1	2.2	CCW	SLV	1/2 X 2 3/4	4 1/2	35035B001, 322P859, DE3L038	L	
A081	SP	3.3	1/40	230	3000	1	0.5	CCW	BALL			35035B001, 322P859, DE3L038	M	33, 116

NOTES: 12: 10M 370V Capacitor 15: 20M 370V Capacitor 24: 15M 370V Capacitor 27: 12.5M 370V Capacitor 31: 5M 370V Capacitor 33: Stainless steel shaft
116: Replacement for Airease 195: 50/60 Hz 200: Not a direct replacement for 5KCP49SG1010S, but is an acceptable substitute.



FIG. A D812



FIG. B D816



FIG. C D818



FIG. D D2817



FIG. E D2814



FIG. F D813



FIG. G D2818, D2816



FIG. H D1008



FIG. I D1100



FIG. J D1104



FIG. K D1117



FIG. L D1091



FIG. M A081



FASCO MODEL	TYPE	DIA.	HP	VOLTS	RPM	SPD.	AMPS	ROT.	BRNG.	SHAFT DIM.	"A" DIM.	CROSS REF.	FIG.	NOTES
MATHIESEN														
K161	SP	-	1/50	115	3000	1	1.05	CCW	SLV	.217 X 1.21		Many Freezer Case Applications	A	
MCMILLAN														
D177	SP	5	1/10 - 1/20	115	1050	2	3.9-1.7	CCW	SLV	3/8 X 3 5/8	2 5/8	6152-366/6	B	
MCQUAY														
D1144	PSC	3.3	1/25 - 1/35 - 1/65	115	1200	3	1.1-.9-.6	CW	SLV	3/8 X 5 3/8	4 3/4	BA2H015	C	1
D1142	SP	3.3	1/15	115/230	1500	1	1.7-.9	CW	SLV	5/16 X 2 1/2	3 1/2	879-382-562-ZB-00	D	175
D1140	PSC	3.3	1/10 - 1/12 - 1/15	115	1500	3	2.2-2-1.7	DS	SLV	5-5/8 X 3/8 X 5 5/8	4 3/4	879-382564B-00	E	13
D1141	PSC	3.3	1/15-1/25-1/35	115	1000	3	1.3-1.1-0.9	DS	SLV	5-5/8 X 3/8 X 5-5/8	4 3/4	879-382563B-00	E	1
D915	PSC	5.6	3/4 - 1/2	460	1075	2	2.5/1.6	REV	BALL	5/8 X 4 1/2	5 1/3	F2417-121479, Marathon EWB48A110558AE	F	24, 115
MIAMI/CAREY														
D534	SP	3.3	1/35 - 1/100	115	1500	1	1.4 - .5	CW	SLV	1/4 X 1	2 1/2	12324L	G	
MILLER														
D1082	SP	5	1/8	115	1070	1	6	CW	BALL	1/2 X 3 1/4	4	MILLER 103080002, FASCO 7152-0020 U.E.; DA3F130N	H	
S156	SP	5	1/6	115	1050	1	6.6	CW	SLV	1/2 X 3 7/8	3 1/2	MMG Series 80 & 100 MOC Series 80 & 100 CFM Series 80 & 100	I	

NOTES: 1: 4M 370V capacitor 13: 7.5M 370V Capacitor 24: 15M 370V Capacitor 115: Not a direct replacement for 253-1194, but is an acceptable substitute 175: Bolt circle = 3.15"



FIG. A K161



FIG. B D177



FIG. C D1144



FIG. D D1142



FIG. E D1140, D1141



FIG. F D915



FIG. G D534



FIG. H D1082



FIG. I S156

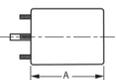

Thermally protected • UL recognized • CSA or ULc certified
NOTE: Rotation is determined by looking at shaft end. Shaft length is measured from motor face.

▶ NEW ITEM! See page 113 for a complete listing of all our new products.



FASCO MODEL	TYPE	DIA.	HP	VOLTS	RPM	SPD.	AMPS	ROT.	BRNG.	SHAFT DIM.	"A" DIM.	CROSS REF.	FIG.	NOTES
NORDYNE														
A131	SP	3.3	1/50	115	3000	1	1.1	CW	SLV			7021-9132, 7021-10171, 7021-10159 7021-9661	A	
A132	SP	3.3	1/50	115	3000	1	1.1	CW	SLV			7021-7975, 6212850	B	
A121	SP	3.3	1/45	240	3000	1	0.5	CW	SLV			7021-10381, 6217930	C	
A122	SP	3.3	1/17	115	3000	1	1.75	CW	SLV			7021-11227, 6219490	D	
A123	SP	3.3	1/18	115	3300	1	1.95	CW	BALL			7021-11385, 622064	E	
A124	SP	3.3	1/15	115	3000	1	1.75	CW	SLV			7021-11379, 6219290	F	
A126	SP	-	1/45	115	3000	1	1.8	CW	BALL			7002-3158, 6219500	G	
NUTONE														
▶ D540	SP	3.3	1/100	115	1500	1	0.6	CW	SLV	1/4 X 2 1/4	2 1/8	Bathroom and Kitchen Vents	H	
▶ D541	SP	3.3	1/100	115	1500	1	0.6	CCW	SLV	1/4 X 2 1/4	2 1/8	26750 Bathroom and Kitchen Vents	H	
▶ D1109	SP	3.3	1/100	115	1500	1	0.65	CCW	SLV	1/4 X 1 1/4	2 1/16	23405, 23388	I	
▶ D1107	SP	3.3	1/10	115	1550	1	3.2	CCW	BALL	5/16 X 1 3/8	4.00"	Nutone 67176, 32997 UE-JA2S034N, JB2K016N	J	
PATTON														
D824	PSC	5.6	1/4 - 1/8	115	1100	2	3.2-2.4	REV	BALL	1/2 X 3 1/2	5 3/4	7126-0485, 7126-0922	K	1
PENN VENTILATOR														
▶ D342	SP	5	1/15	115	1050	1	2.3	CW	SLV	3/8 X 2 1/2	2 5/8	7151-3081, 7151-3565	L	34
▶ D1036	SP	5	1/20	115	1045	1	1.95	CW	SLV	3/8 X 2 1/8	2 3/8	7151-2139 ROOF TOP VENT Z8	L	
PMI FOOD EQUIPMENT/ VALCUN HART														
A142	PSC	3.3	1/20	115	3450	1	0.7	CW	SLV			7062-2513, 416673-00003	M	1

NOTES: 1: 4M 370V capacitor 34: Mounts on (3) P/N 0061-1518 Coleman Mounts



FIG. A A131



FIG. B A132



FIG. C A121



FIG. D A122



FIG. E A123



FIG. F A124



FIG. G A126



FIG. H D540, D541



FIG. I D1109



FIG. J D1107



FIG. K D824



FIG. L D342, D1036



FIG. M A142



FASCO MODEL	TYPE	DIA.	HP	VOLTS	RPM	SPD.	AMPS	ROT.	BRNG.	SHAFT DIM.	"A" DIM.	CROSS REF.	FIG.	NOTES
RHEEM/RUUD														
A066	SP	-	1/30	120	3000	1	1.27	CW	BALL			70-24157-03, 117847-00	A	
A240	SP	3.3	1/50	115	3000	1	1.1	CCW	SLV			7021-8183, 70-21496-83	B	
A241	SP	3.3	1/25	208-230	3200	1	0.62	CW	SLV			7021-9567, 70-23641-81	C	
A242	SP	3.3	1/50	115	3400	1	1.36	CW	SLV			7021-7150, 70-22436-01	D	
A243	SP	3.3	1/50	115	3400	1	1.36	CW	SLV			7021-7790, 70-22436-02	E	
A244	SP	3.3	1/20	208-230	3300	1	0.85	CCW	BALL			7021-6967, 70-42241-01	F	
A245	SP	3.3	1/15	208-230	3000	1	.95/.85	CW	BALL			7021-7490, 70-42278-02	G	
A246	PSC	3.3	1/20	115	3400/2400	2	0.85	CW	BALL			7062-3925, 70-24206-01	H	
A247	PSC	3.3	1/40	115	3250/2800	2	.95	CW	SLV			7062-5519	I	
D724	PSC	5.6	3/4 - 1/2 - 1/3 - 1/4	115	1075	4	9.5-7.2-5.6-3.5	REV	SLV	1/2 X 6	5 3/4	VARIOUS	J	
D806	PSC	5.6	1/2 - 1/3 - 1/4 - 1/5	115	1075	4	7.3	REV	SLV	1/2 X 3 3/4	4 3/4	51-23012-41	J	
D2800	PSC	5.6	1/2	208/230	1075	1	2.9	REV	SLV	1/2 X 5	5	K55HXMYC-4445, 51-23052-11	K	36
D2834	PSC	5.6	1/3	208/230	1075	1	2	CW	SLV	1/2 X 4 1/4	4	51-21853-83	L	
D2840	PSC	5.6	1/5	208/230	1075	1	1.3	CW	SLV	1/2 X 4 1/8	3 3/4	51-21853-82	L	
D2842	PSC	5.6	1/6	208/230	825	1	1.2	CW	SLV	1/2 X 4 1/4	4	51-20760-11	M	
D832	PSC	5.6	1/8	208-230	825	1	1.1	REV	SLV	1/2 X 4 3/4	4	21276-02, 21276-01, 512076-01	N	
D2844	PSC	5.6	1/10	208/230	825	1	0.8	CW	SLV	1/2 X 4 1/4	3 3/4	51-20761-11	M	

NOTES: 36: Has 4 drilled and tapped holes in shell



FIG. A A066



FIG. B A240



FIG. C A241



FIG. D A242



FIG. E A243



FIG. F A244



FIG. G A245



FIG. H A246



FIG. I A247



FIG. J D724, D806



FIG. K D2800



FIG. L D2834, D2840



FIG. M D2842, D2844



FIG. N D832

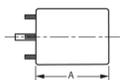

NEW ITEM! See page 113 for a complete listing of all our new products.

Thermally protected • UL recognized • CSA or ULc certified

NOTE: Rotation is determined by looking at shaft end. Shaft length is measured from motor face.



FASCO MODEL	TYPE	DIA.	HP	VOLTS	RPM	SPD.	AMPS	ROT.	BRNG.	SHAFT DIM.	"A" DIM.	CROSS REF.	FIG.	NOTES
REZNOR														
D461	PSC	3.3	1/8	480	3200	1	0.32	CCW	SLV	5/16 X 3 1/3	4 1/4	7162-0396	A	
RHEEM/RUUD														
D459	SP	3.3	1/15	230/460	3000	1	1.2-.6	CW	BALL	1/4 X 3	7	HC24AU725A, JB1P044, AB1S078, JB1R039, AB1S029, S88-556	B	
K628	SP	-	1/200	208-230	3000	1	0.25	CW	SLV	1/4 X 1 1/2	5	51-21964-01, 7102-0628	C	
A079	SP	3.3	1/50	115	3000	1	1.1	CCW	SLV			74-70-21504-03-04, 74-70-21496-03-01, JAIM106, JAIM137, 7021-5615	D	
A086	SP	3.3	1/25	115	3200	1	1.3	CW	SLV			7021-5990	E	
A090	SP	3.3	1/50	115	3000	1	1.1	CW	SLV			RHEEM 70-21496-01, 7021-5239 JAIM102	F	
A136	PSC	3.3	1/20	115	3450	1	0.75	CW	SLV			RHEEM, 7062-3861	G	38
A139	SP	3.3	1/55	115	3000	1	0.95	CW	SLV			RHEEM, 7021-7577	H	
A142	PSC	3.3	1/20	115	3450	1	0.7	CW	SLV			RHEEM, 7062-1881	I	39
SCHERBA IND.														
A087	PSC	3.3	1/6	115/230	2400	1	2.8/1.1	CCW	SLV			7062-4687, 7062-3496	J	195
SEARS/WHIRLPOOL														
D137	SP	3.3	1/30 - 1/65	115	1500	1	1-.7	DS	SLV	3 X 5/16 X 3	2 7/8	Rangehood	K	
D1111	SP	3.3	1/18 - 1/30	115	1330	2	2.4-1.6	CCW	SLV	3 1/8 X 5/16 X 2 3/8	3 1/2	JA2S094, JA2S110, JA2S121N, A456301 A495601, A495603, 5500 BTU Window A/C; G000519549; G519549	L	
D323	PSC	3.3	1/15 - 1/20 - 1/35	115	1550	3	1-.8-.6	DS	SLV	2 3/4 X 5/16 X 2 3/4	3 3/4	Small Window A/C	M	9
D325	SP	3.3	1/10 - 1/30	115	1550	2	2.5-2.3	CCW	SLV	1 3/4 X 5/16 X 2 3/8	3 1/2	Small Window A/C	N	18

NOTES: 9: 3M 370V capacitor 18: Rotation is determined by viewing lug end. 38: 4MFD, 370VAC capacitor rating (not included) 39: 4MFD, 370VAC capacitor rating (included) 195: 50/60 Hz



FIG. A D461



FIG. B D459



FIG. C K628



FIG. D A079



FIG. E A086



FIG. F A090



FIG. G A136



FIG. H A139



FIG. I A142



FIG. J A087



FIG. K D137



FIG. L D1111



FIG. M D323



FIG. N D325



FASCO MODEL	TYPE	DIA.	HP	VOLTS	RPM	SPD.	AMPS	ROT.	BRNG.	SHAFT DIM.	"A" DIM.	CROSS REF.	FIG.	NOTES
SEARS/WHIRLPOOL														
D857	PSC	5.6	1/8 - 1/10 - 1/15	115	1100	3	1.7	DS	SLV	3 1/8 X 1/2 X 4 1/8	3 1/2	Window A/C Using Delco Inside-Outside Motor 485932, KCP39PG9769S	A	
D859	PSC	5.6	1/3 - 1/5 - 1/8	230	1100	3	1.7-1.5-1.3	DS	SLV	4 1/4 X 1/2 X 5 1/4	4 1/4		A	205
D860	PSC	5.6	1/2 - 1/3 - 1/4	230	1075	3	3.2	DS	SLV	4 1/4 X 1/2 X 4 3/8	5 3/4		B	13, 205
SINGER														
D1169	SP	3.3	1/10	208-230	3000	1	1.5	CCW	SLV	5/16 X 1	5 3/4	FASCO 7121-4066 Comfor Maker 1708-507	C	
D1164	SP	3.3	1/25	115/230	1550	1	1.3-.65	CW	SLV	5/16 X 2 1/2	3 1/8	JA2P091N, JA2P0901N	D	
D1167	SP	3.3	1/40	208-230	3000	1	0.55	CCW	SLV	5/16 X 1	4 7/8	1708-518, 7121-5854	E	
SKYMARK														
A251	SP	3.3	1/35	208-230	3000	1	1.1	CCW	SLV			7021-9136, MTR-136PK	F	
TAPPAN														
A073	SP	3.3	1/40	115-230	3000	1	.7/35	CCW	BALL			82932, 8251560133	G	
TECUMSEH														
D475	SP	3.3	1/15	460	1550	1	0.5	CCW	SLV	5/16 X 2 1/2	4 1/2	Tecumseh 810G037A47, 5KCP11FG1197CS	H	
TEMPMASTER/OTASCO														
D1033	PSC	5	1/5 - 1/6 - 1/8	208-230	1400	3	1.6-1.5-1.3	DS	SLV	2-3/4 X 1/2 X 3 1/2		M11730, 322P373, M12100, 322P454	I	
THERMADOR (TRADEWINDS)														
D1165	SP	3.3	1/20	115	1550	1	2	DS	SLV	3 1/2 X 5/16 X 3 1/2		Tradewinds/Blower Motors	J	
D1155	SP	3.3	1/100	115	1085	1	0.5	CCW	SLV	1/4 X 1		17-09-679, VQT-90, JA2M087R	K	
THERMAL TRANSFER														
D1006	SP	4.4	1/4	115	1600	1	7.2	CW	SLV	1/2 X 2 3/4		7108-6544, 66098	L	
TJERNLUND														
D130	SP	3.3	1/40	115	1500	1	1	CW	SLV	5/16 X 4 1/8		7163-6058	M	

NOTES: 13: 7.5M 370V Capacitor 205: Window A/C Using Delco Inside-Outside Motor 485932, KCP39PG9769S



FIG. A D857, D859



FIG. B D860



FIG. C D1169



FIG. D D1164



FIG. E D1167



FIG. F A251



FIG. G A073



FIG. H D475



FIG. I D1033



FIG. J D1165



FIG. K D1155



FIG. L D1006



FIG. M D130



Thermally protected • UL recognized • CSA or ULc certified
NOTE: Rotation is determined by looking at shaft end. Shaft length is measured from motor face.



FASCO MODEL	TYPE	DIA.	HP	VOLTS	RPM	SPD.	AMPS	ROT.	BRNG.	CROSS REF.	FIG.	NOTES
TRANE												
A069	SP	3.3	1/70	208-240	3000	1	0.5	CCW	SLV	38040252, 82252	A	
A075	SP	3.3	1/40	230	3000	1	0.4	CCW	BALL	38050005	B	
A143	SP	3.3	1/50	115	3000	1	0.95	CW	SLV	7021-8428, 7021-8013, 7021-8924	C	
A146	SP	3.3	1/100	115	3000	2	1-.35	CW	SLV	7021-7986, 7021-8925, 7002-2531	D	
A130	PSC	3.3	1/20	115	3450	1	0.7	CW	SLV	7062-3956, 7062-3616, 7062-5247, 7062-5575, D330757P04, D342094P04	E	
A150	SP	3.3	1/35	208-230	3000	1	0.5	CCW	SLV	7021-7833, 7021-8928	F	
A191	SP	3.3	1/15	208-230	3000	1	0.8	CCW	SLV	7021-6683, X38040251-01-7	G	
A192	SP	3.3	1/40	115	3000	1	1	CCW	BALL	7021-8569, X38040253057	H	
A193	SP	3.3	1/35	208-240	3480	1	.59/5	CCW	BALL	7021-8591, X38040050-01-0	I	
A194	SP	3.3	1/80	115	3000/1950	2	1/5	CW	SLV	7021-9561, X38020420017	J	
A195	SP	3.3	1/16	115	3400	1	1.75	CW	BALL	7021-11543, X38040313070	K	
A196	SP	3.3	1/25	115	3200	1	1.35	CW	SLV	7021-11544, D342094P02, 7021-9010, D330757P02	L	
A197	3 PHASE	3.3	1/70	33-110	1500-4700	VAR.	1	CW	BALL	7092-0238, D342097P01	M	



FIG. A A069



FIG. B A075



FIG. C A143



FIG. D A146



FIG. E A130



FIG. F A150



FIG. G A191



FIG. H A192



FIG. I A193



FIG. J A194



FIG. K A195



FIG. L A196



FIG. M A197



FASCO MODEL	TYPE	DIA.	HP	VOLTS	RPM	SPD.	AMPS	ROT.	BRNG.	CROSS REF.	FIG.	NOTES
TRANE												
A198	SP	-	1/45	115	3000	1	1.75	CW	BALL	7058-0259, D342077P01	A	
A199	SP	-	1/45	115	3000	1	1.75	CW	BALL	7058-0260, D342077P02	A	
A260	SP	-	1/45	115	3250	1	1	CW	BALL	7058-0261, D342077P03	A	
A261	SP	-	1/45	115	3250	1	1	CW	BALL	7058-0262, D342077P04	A	
A262	SP	-	1/45	115	3250	1	1	CW	BALL	7058-0263, D34077P05	A	
A263	SP	-	1/45	115	3250	1	1	CW	BALL	7058-0264, D34077P06	A	
A264	SP	-	1/120	115	3000	2	0.75	CW	BALL	7002-3443, D342078P01	A	
A265	SP	-	1/125	115	3000	2	0.75	CW	BALL	7002-3444, D342078P02	A	
A266	SP	-	1/125	115	3000	2	1	CW	BALL	7002-3445, D342078P04	A	
A267	SP	-	1/125	115	3000	2	1.4	CW	BALL	7002-3446, D342078P05	A	
A268	SP	-	1/45	115	3000	2	1.4	CW	BALL	7002-3447, D342078P06	A	
A269	SP	3.3	1/35	208-230	2500/3000	1	.58/6	CCW	BALL	7021-11054, X38040363010	B	195
A270	PSC	3.3	1/15	208-230	3350/2800	2	.42/50	CCW	BALL	7062-5033, X38040369010	C	195
A271	PSC	3.3	1/18	208-230	3500	2	0.62	CW	BALL	7062-3969, X38040308-01	D	195
A272	PSC	3.3	1/12	208-230	3500	2	0.65	CW	BALL	7062-3971, X38040309-01	D	195
A273	PSC	3.3	1/8	208-230	3500	2	0.62	CW	BALL	7062-3972, X38040310-01	D	195
A274	PSC	3.3	1/24	208-230	3500	1	.28	CW	BALL	7062-3973, X38040311-01	D	195
A276	SP	3.3	1/55	115	3000	1	1	CW	SLV	7021-9011, D330757P01	E	
A278	SP	-	1/50	115	3000	2	1.4	CW	BALL	7002-2530, D341095P02	F	
A279	SP	-	1/125	115	3000	2	0.75	CW	BALL	7002-2531, D341095P04, 7002-3275, D341663P04	F	

NOTES: 195: 50/60 Hz



FIG. A A198, A199, A260, A261, A262, A263, A264, A265, A266, A267, A268



FIG. B A269



FIG. C A270



FIG. D A271, A272, A273, A274



FIG. E A276



FIG. F A278, A279

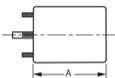

Thermally protected • UL recognized • CSA or ULc certified
NOTE: Rotation is determined by looking at shaft end. Shaft length is measured from motor face.

NEW ITEM! See page 113 for a complete listing of all our new products.



FASCO MODEL	TYPE	DIA.	HP	VOLTS	RPM	SPD.	AMPS	ROT.	BRNG.	SHAFT DIM.	CROSS REF.	FIG.	NOTES
TRANE													
A360	SP	-	1/25	115	2700	2	1	CW	BALL		7002-2532, D341095P01, 7002-3274, D341663P01	A	
A361	SP	-	1/42	115	3000	1	1.6	CW	BALL		7002-2558, D330787P01	B	
A362	SP	-	1/42	115	3000	1	1.6	CW	BALL		7002-3273, D341663P05	A	
A367	SP	3.3	1/60	115	3000	2	.95	CW	SLV		7021-8051, 21D340096P02	C	
A368	PSC	3.3	1/20	115	3200	2	0.8	CW	SLV		7062-3782, D340623P01	D	
A369	PSC	3.3	1/45	208-230	2800	2	.34	CCW	BALL		7062-3915, C663946P01	E	
A370	PSC	3.3	1/100	208-230	2920	2	0.18	CCW	BALL		7062-3918, C664099P01	E	
A373	SP	3.3	1/35	280-230	3000	1	0.6	CCW	BALL		7021-9396, C665662P01	F	
D1050	PSC	5	1/8	230	1550	1	1.1	CW	SLV	1/2 X 3	WW94X236SP, WW94X936PSC	G	199
D895	PSC	5.6	1/8	208-230	1650	1	0.8	CW	SLV	1/2 X 1 1/2	5KCP39BGR426S, MOT 6363	H	1
D1005	PSC	5	1/10	460	1075	2	0.5	DS	SLV	9 5/8 X 1/2 X 9 5/8	5KCP29DK3857BT, MOT 4590	I	
D1089	PSC	5	1/15	115	850	3	1.3	REV	SLV	1/2 X 3	5KCP39DGM458AS, K48HX-CFC-1327, MOT3589, MOT 3591, FASCO 7176-3020	J	1
D1090	PSC	5	1/15	115	1100	3	0.8	CW	SLV	10 1/2 X 1/2 X 11 1/2	MOT1877, K48HXBLA-956	K	
D1051	PSC	5	1/25 - 1/40	115	1060 - 500	2	.6-.4	DS	SLV	11 1/8 X 1/2 X 11 1/8	FAN COIL	L	3
D1058	PSC	5	1/20 - 1/30 - 1/40	265	1100	3	.5-.3-.2	CW	SLV	1/2 X 2 1/2	5 KCP29FK885S	M	1
D2850	PSC	5.6	1 - 3/4	208-230/460 60 HZ, 200/380-415 50 HZ	1125/950	1	4.6/2.3	CW	BALL	1/2 X 3.45	5KCP39SFL153DS (GE); MOT05717 Trane X70671180017, X70670706010, MOT03771, MOT05717	N	20

NOTES: 1: 4M 370V capacitor 3: 6M 370V capacitor 20: Not a direct replacement, but suitable for referenced models. 199: Original motor is SP, D1050 is PSC to provide greater motor efficiency and permit closing shaft end of motor to prevent moisture from entering motor



FIG. A A360, A362



FIG. B A361



FIG. C A367



FIG. D A368



FIG. E A369, A370



FIG. F A373



FIG. G D1050



FIG. H D895



FIG. I D1005



FIG. J D1089



FIG. K D1090



FIG. L D1051



FIG. M D1058



FIG. N D2850



FASCO MODEL	TYPE	DIA.	HP	VOLTS	RPM	SPD.	AMPS	ROT.	BRNG.	SHAFT DIM.	"A" DIM.	CROSS REF.	FIG.	NOTES
20TH CENTURY														
A086	SP	3.3	1/25	115	3200	1	1.3	CW	SLV			7021-5853	A	
TRANE														
D2851	PSC	5.6	1 - 3/4	208-230/460 60 HZ, 200/380-415 50 HZ	1125/950	1	4.6/2.3	CW	BALL	5/8 X 3.75 Keyed	6 1/2	5KCP39SFL153DS (GE); MOT09188 MOT09188, MOT09192, Trane X7067165301 X70671656010	B	
TYLER														
D870	PSC	5.6	1/4	230	1625	1	1.9	CW	BALL	1/2 X 3	4 3/4	5KCP39EGC053T, UNIT NO. 760	C	29
WEIL MCLAIN														
D1190	SP	3.3	1/30	115	3000	1	1.6	CW	SLV	5/16 X 1 3/4	4 7/8	7121-5750, JA1N074	D	
WEST BEND/MCGRAW EDISON														
D1134	SP	3.3	1/50 - 1/65 - 1/80	115	1500	3	1.1-8-.6	CW	SLV	1/4 X 1 3/4	2 1/4	Portable Humidifier Motors	E	
WESTINGHOUSE														
D262	PSC	5	1/5	230	925	1	2.3	REV	SLV	1/2 X 4	3 7/8	Whisperaire 319P300A	F	
D1032	PSC	5	1/5	208-230	1550	1	1.6	DS	SLV	6 1/4 X 1/2 X 6 1/4	3 7/8	Model No. 319P367A	G	
D1111	SP	3.3	1/18 - 1/30	115	1330	2	2.4-1.6	CCW	SLV	3 1/8 X 5/16 X 2 3/8	3 1/2	JA2S094, JA2S110, JA2S121N, A456301 A495601, A495603, 5308013815, 5500 BTU WINDOW A/C; G000519549; G519549	H	
WHITE CONSOLIDATED INDUSTRIES														
D1111	SP	3.3	1/18 - 1/30	115	1330	2	2.4-1.6	CCW	SLV	3 1/8 X 5/16 X 2 3/8	3 1/2	JA2S094, JA2S110, JA2S121N, A456301 A495601, A495603, 5308013815, 5500 BTU WINDOW A/C	H	
WITT														
D1102	PSC	3.3	1/20	115/230	1550	1	.75-.4	CW	SLV	5/16 X 2-5/8	3 1/2	7190-2158, 8216073, 7190- 2159, 8216074	I	

NOTES: 29: 4M 370V capacitor included



FIG. A A086



FIG. B D2851



FIG. C D870



FIG. D D1190



FIG. E D1134



FIG. F D262



FIG. G D1032



FIG. H D1111



FIG. I D1102



Thermally protected • UL recognized • CSA or ULc certified
NOTE: Rotation is determined by looking at shaft end. Shaft length is measured from motor face.



FASCO MODEL	TYPE	DIA.	HP	VOLTS	RPM	SPD.	AMPS	ROT.	BRNG.	SHAFT DIM.	CROSS REF.	FIG.	NOTES
WILLIAMSON													
A080	SP	3.3	1/45	115	3000	1	1.1	CW	SLV		7021-5510, 02-568	A	
A118	SP	3.3	1/15	115	3000	1	1.8	CW	SLV		100,000 BTU Furnace 7021-6999, 7021-7042, Leads must be modified	B	
YORK													
D1191	SP	3.3	1/40	460	3200	1	0.37	CCW	BALL	1/4 X 2-1/2	7121-7255	C	33, 41, 131
D1171	SP	3.3	1/15	460	3000	1	0.6	CCW	BALL	1/4 X 2-1/2	024-24115-004 F33HXJBB3621	D	41
D1042	PSC	5	1/5	208-230	1075	1	1.2	DS	SLV	6 1/2 X 1/2 X 6 1/2	Cond. Fan, D1041 F47HXBGM-927	E	
D873	PSC	5.6	1/2	230	1050	1	3.2	DS	SLV	9 3/4 X 1/2 X 9 3/4	K44HXJAF-4955	F	
D2871	PSC	5.6	1 - 3/4 - 1/2	460	1100	3	3.3-2.3-1.9	REV	SLV	1/2 X 3 1/2	024-21673, K55HXJFJ-2832, 5KCP39SGH913BS	G	42, 198
A063	SP	3.3	1/56	230	3000	1	0.6	CCW	BALL		26-22239	H	
A083	SP	3.3	1/60	230	3000	1	0.8	CCW	BALL		026-16323-0000, 026-20224-000, 7021-1373	I	
A144	SP	3.3	1/40	208-230	3000	1	0.5	CW	SLV		7021-6770	J	41
A137	PSC	3.3	1/25	115	3450	1	0.7	CW	SLV		7062-2442, 7062-3342, 7062-3484	K	
A154	SP	3.3	1/30	115	3000	1	1.2	CW	SLV		7021-9428	L	
A165	PSC	3.3	1/25	115	3450	1	0.7	CW	BALL		7062-3958	M	
A168	PSC	3.3	1/20	115	3450	1	0.7	CW	BALL		7062-5019	N	

NOTES: 33: Stainless steel shaft 41: Includes centrifugal switch 42: 25M 370V Capacitor 131: Motors include shaft bushing 198: Has special OEM wiring configuration. Not for general purpose 3 speed applications



FIG. A **A080**



FIG. B **A118**



FIG. C **D1191**



FIG. D **D1171**



FIG. E **D1042**



FIG. F **D873**



FIG. G **D2871**



FIG. H **A063**



FIG. I **A083**



FIG. J **A144**



FIG. K **A137**



FIG. L **A154**



FIG. M **A165**



FIG. N **A168**



FASCO MODEL	TYPE	DIA.	HP	VOLTS	RPM	SPD.	AMPS	ROT.	BRNG.	CROSS REF.	FIG.	NOTES
YORK												
A220	SP	3.3	1/20	115	3000	1	1.6	CW	BALL	7021-5838, 026-27510-700, 7021-7217, 7021-9054	A	
A221	SP	3.3	1/40	208-230	3000	1	0.55	CCW	SLV	7021-8318, 026-30614-700, 7021-6991	B	
A222	SP	3.3	1/35	115	3000	1	1.05	CCW	BALL	7021-8317, 026-32067-700, 7021-7481	C	
A223	SP	3.3	1/30	208-230	3200	1	0.64	CW	SLV	7021-10096, 026-33999-001, 7021-9656	D	
A224	SP	3.3	1/18	115	3450	2	0.8	CW	SLV	7062-5048, 024-27654-000, 7062-4743	E	
A225	SP	3.3	1/15	115	3200	1	2.25	CW	BALL	7021-11577, 17503, 7021-11830, 024-34558-000	F	
A226	SP	-	1/35	115	3000	1	1.7	CW	BALL	7058-0266, 7058-0266S	G	
A227	PSC	3.3	1/25	115	3450	1	0.7	CW	SLV	7062-4708S, 024-27641-000, 17450, 7062-4708	H	
A228	SP	-	1/25	115	3000	1	2	CW	BALL	7002-3285, 024-31957-000, 7002-2941	I	
A229	SP	-	1/25	115	3000	1	1.75	CW	BALL	7058-0267S, 17499, 7058-0267	J	
A230	PSC	3.3	1/20	115	3450	2	0.8	CW	SLV	7062-5094S, 17476, 7062-5094	K	
A231	SP	3.3	1/75	115	3000	2	1.3	CW	SLV	7021-10213, 17452	L	
A234	PSC	3.3	1/12	208-230	3200	1	0.5	CW	BALL	7062-5155, 102529	M	



FIG. A A220



FIG. B A221



FIG. C A222



FIG. D A223



FIG. E A224



FIG. F A225



FIG. G A226



FIG. H A227



FIG. I A228



FIG. J A229



FIG. K A230



FIG. L A231



FIG. M A234



Thermally protected • UL recognized • CSA or ULc certified
NOTE: Rotation is determined by looking at shaft end. Shaft length is measured from motor face.



DEFINITE PURPOSE CONTACTORS

FASCO MODEL	POLE	F/L IND. AMPS	LOCKED ROTOR AMPS 240/480/600	RES. AMPS	COIL AC VOLTS	COIL VA INRUSH 60 HZ	COIL VA SEALED 60 HZ	COIL VA INRUSH 50 HZ	COIL VA SEALED 50 HZ	HP 120V 1 PH	HP 208V 1 PH	HP 240V 1 PH	HP 208V 3 PH	HP 240V 3 PH	HP 480V 3 PH	HP 600V 3 PH	FIG.
H330A	3	30	180/150/120	40	24	60	6	65	7.5	2	—	5	—	10	15	20	A
H330B	3	30	180/150/120	40	120	60	6	65	7.5	2	—	5	—	10	15	20	A
H330C	3	30	180/150/120	40	208/240	60	6	65	7.5	2	—	5	—	10	15	20	A
H340A	3	40	240/200/160	50	24	60	6	65	7.5	3	—	3	—	10	20	25	B
H340B	3	40	240/200/160	50	120	60	6	65	7.5	3	—	3	—	10	20	25	B
H340C	3	40	240/200/160	50	208/240	60	6	65	7.5	3	—	3	—	10	20	25	B
H350A	3	50	300/250/200	65	24	120	16	129	17.5	3	7.5	7.5	15	15	25	25	C
H350B	3	50	300/250/200	65	120	120	16	129	17.5	3	7.5	7.5	15	15	25	25	C
H350C	3	50	300/250/200	65	208/240	125	16	129	17.5	3	7.5	7.5	15	15	25	25	C
H360A	3	60	360/300/240	75	24	120	16	129	17.5	5	7.5	7.5	25	25	30	30	C
H360B	3	60	360/300/240	75	120	120	16	129	17.5	5	7.5	7.5	25	25	30	30	C
H360C	3	60	360/300/240	75	208/240	125	16	129	17.5	5	7.5	7.5	25	25	30	30	C
H375AC	3	75	450/375/300	93	24	240	27	285	42	5	15	15	25	25	40	40	C
H375BC	3	75	450/375/300	93	120	240	27	285	42	5	15	15	25	25	40	40	D
H375CC	3	75	450/375/300	93	208/240	240	27	285	42	5	15	15	25	25	40	40	D
H390AC	3	90	540/450/360	120	24	240	27	285	42	7.5	20	20	30	30	50	50	D
H390BC	3	90	540/450/360	120	120	240	27	285	42	7.5	20	20	30	30	50	50	D
H390CC	3	90	540/450/360	120	208/240	240	27	285	42	7.5	20	20	30	30	50	50	D
H430A	4	30	180/150/120	40	24	60	6	65	7.5	2	—	5	—	10	15	—	E
H430B	4	30	180/150/120	40	120	60	6	65	7.5	2	—	5	—	10	15	—	E
H430C	4	30	180/150/120	40	208/240	60	6	65	7.5	2	—	5	—	10	15	—	E
H440A	4	40	240/200/160	50	24	60	6	65	7.5	3	—	7.5	—	10	20	—	F
H440B	4	40	240/200/160	50	120	60	6	65	7.5	3	—	7.5	—	10	20	—	F
H440C	4	40	240/200/160	50	208/240	60	6	65	7.5	3	—	7.5	—	10	20	—	F

REVERSING CONTACTORS

FASCO MODEL	POLE	F/L IND. AMPS	LOCKED ROTOR AMPS 240/480/600	RES. AMPS	COIL AC VOLTS	COIL VA INRUSH 60 HZ	COIL VA SEALED 60 HZ	COIL VA INRUSH 50 HZ	COIL VA SEALED 50 HZ	HP 120V 1 PH	HP 208V 1 PH	HP 240V 1 PH	HP 208V 3 PH	HP 240V 3 PH	HP 480V 3 PH	HP 600V 3 PH	FIG.
H3R30A	3	30	180/150/120	40	24	60	6	65	7.5	—	—	—	—	10	15	20	G
H3R30B	3	30	180/150/120	40	120	60	6	65	7.5	—	—	—	—	10	15	20	G
H3R30C	3	30	180/150/120	40	208/240	60	6	65	7.5	—	—	—	—	10	15	20	G



FIG. A H330A, H330B, H330C

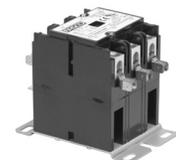
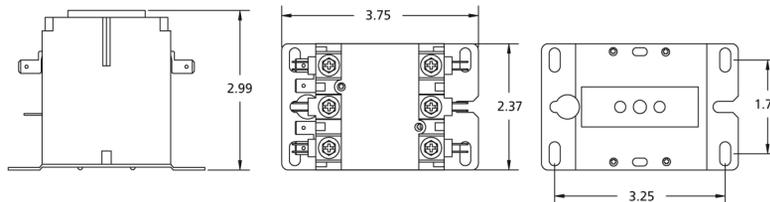

FIG. A H340A, H340B, H340C

REPLACEMENT PARTS

FASCO MODEL	POLE	USE AUX. SWITCH	FIG.
H330A	3	H6S or H7S	A
H330B	3	H6S or H7S	A
H330C	3	H6S or H7S	A
H340A	3	H6S or H7S	B
H340B	3	H6S or H7S	B
H340C	3	H6S or H7S	B
H350A	3	H6S or H7S	C
H350B	3	H6S or H7S	C
H350C	3	H6S or H7S	C
H360A	3	H6S or H7S	C
H360B	3	H6S or H7S	C
H360C	3	H6S or H7S	C
H375AC	3	H9S	D
H375BC	3	H9S	D
H375CC	3	H9S	D
H390AC	3	H9S	D
H390BC	3	H9S	D
H390CC	3	H9S	D
H430A	4	H6S or H7S	E
H430B	4	H6S or H7S	E
H430C	4	H6S or H7S	E
H440A	4	H6S or H7S	A
H440B	4	H6S or H7S	A
H440C	4	H6S or H7S	A
H3R30A	3	H6S or H7S	G
H3R30B	3	H6S or H7S	G
H3R30C	3	H6S or H7S	G

- 30 Amp - Screws and quick connect terminals.
- 40 Amp - Lugs and quick connect terminals.
- 50/60 Amp - Lugs and quick connect terminals.
- 75/90 - Lugs and quick connect terminals.

AUXILIARY SWITCHES

FASCO MODEL	TYPE	FIG.
H6S	SPDT	H
H7S	DUAL SPDT	I
H9S	SPDT	J

- 10 Amp @ 1/3 HP, 125 or 250 VAC.
- 1/2 Amp @ 125 VDC.
- 1/4 Amp @ 250 VDC.

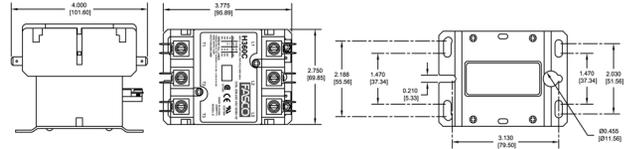
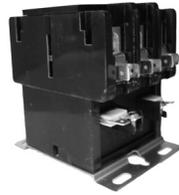

FIG. C H350A, H350B, H350C, H360A, H360B, H360C

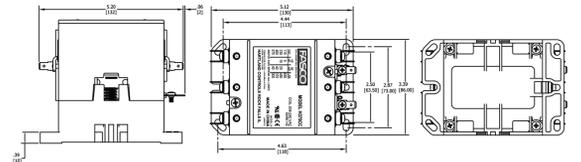

FIG. D H375AC, H375BC, H375CC, H390AC, H390BC, H390CC

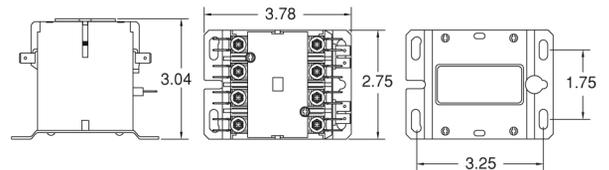

FIG. E H430A, H430B, H430C

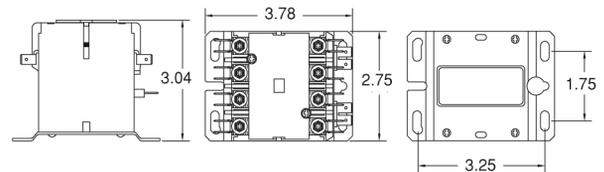

FIG. A H440A, H440B, H440C

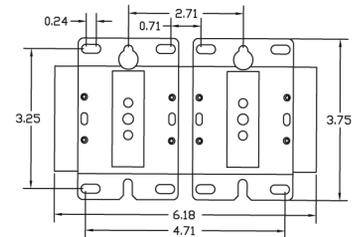

FIG. G H3R30A, H3R30B, H3R30C



FIG. H H6S



FIG. I H7S



FIG. J H9S

Thermally protected • UL recognized • CSA or ULc certified
NOTE: Rotation is determined by looking at shaft end. Shaft length is measured from motor face.



FASCO MODEL	POLE	FL INDUCTIVE AMPS	LOCKED ROTOR AMPS 240/480/600	RES. AMPS	COIL AC VOLTS	COIL VA INRUSH 60 HZ	COIL VA SEALED 60 HZ	COIL VA INRUSH 50 HZ	COIL VA SEALED 50 HZ	HP 120V 1 PH	HP 240V 1 PH	FIG.
H130A	1	30	150/125/100	40	24	28	5	31	6	1	2	A
H130B	1	30	150/125/100	40	120	28	5	31	6	1	2	A
H130C	1	30	150/125/100	40	208/240	28	5	31	6	1	2	A
H140A	1	40	240/160/120	50	24	28	5	31	6	2	3	B
H140B	1	40	240/160/120	50	120	28	5	31	6	2	3	B
H140C	1	40	240/160/120	50	208/240	28	5	31	6	2	3	B
H230A	2	30	150/125/100	40	24	30	6.5	33	8	2	3	C
H230B	2	30	150/125/100	40	120	30	6.5	33	8	2	3	C
H230C	2	30	150/125/100	40	208/240	30	6.5	33	8	2	3	C
H240A	2	40	240/160/120	50	24	30	6.5	33	8	2	3	D
H240B	2	40	240/160/120	50	120	30	6.5	33	8	2	3	D
H240C	2	40	240/160/120	50	208/240	30	6.5	33	8	2	3	D

SINGLE POLE

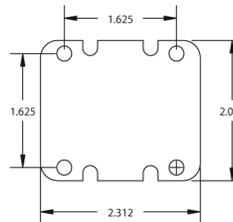
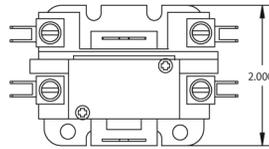
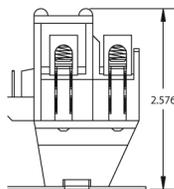

FIG. A H130A, H130B, H130C

FIG. B H140A, H140B, H140C

TWO POLE

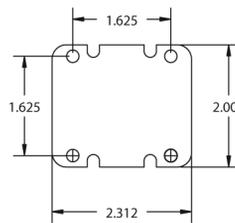
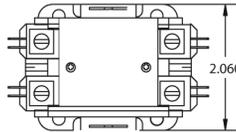
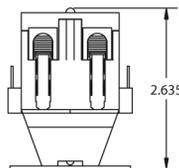

FIG. C H230A, H230B, H230C

FIG. D H240A, H240B, H240C

- Fasco contactors meet specifications for devices up to 600 VAC in accordance with UL Bulletin No. 508, "Industrial Control Equipment."
- Coils have Class B insulation.
- 30 Amp - Screws and quick connect terminals.
- 40 Amp - Lugs and quick connect terminals.



2 and 3 Blade, Interchangeable Hub Condenser (Pressure) Type *FAN BLADES*

FEATURES

- 18 to 24 inch diameters
- High quality, heavy duty aluminum blades
- Zinc and dichromate plated steel spiders
- For use with interchangeable hex hubs
- Blades tested at 1000 RPM

TYPICAL APPLICATIONS

- Air-conditioning condensers
- Power roof ventilators
- Heat pumps
- Heat exchangers
- Unit heaters
- Commercial and industrial equipment

PART NUMBER BREAKDOWN					
NO. OF BLADES	FAN BLADE TYPES	ROTATION	BLADE DIAMETER	BLADE PITCH	HUB BORE SIZE
2- 3- 4- 5- Etc...	C-Condenser F- Free Air S- Slinger Ring	R-Right, CW Viewing Air Discharge Side L-Left, CCS Viewing Air Discharge Side	In Inches	In Degrees	1=1/4" HUB I.D. 2=5/16" HUB I.D. 3=3/8" HUB I.D. 4=1/2" HUB I.D. 5=5/8" HUB I.D. 6=3/4" HUB I.D.
EXAMPLE					
3	C	R	18	33	4 (fixed hubs only)

THREE BLADE									
MODEL	FAN			STATIC PRESSURE				STD PACK	MAX RPM
	ROTATION	DIA (IN)	PITCH (DEG)	0"		.30"			
				CFM	BHP	CFM	BHP		
3CR1827	C.W.	18	27	2450	0.1	1260	0.14	2	1725
3CR1833	C.W.		33	2830	0.14	1620	0.21		
3CR2024	C.W.	20	24	3160	0.17	2010	0.23	2	1725
3CR2028	C.W.		28	3560	0.21	2410	0.27		
3CR2031	C.W.		31	3870	0.24	2680	0.3		
3CR2426	C.W.	24	26	5860	0.42	4600	0.49	2	1140
3CR2433	C.W.		33	7010	0.63	5600	0.7		

TWO BLADE									
MODEL	FAN			STATIC PRESSURE				STD PACK	MAX RPM
	ROTATION	DIA (IN)	PITCH (DEG)	0"		.30"			
				CFM	BHP	CFM	BHP		
2CL1827	C.C.W.	18	27	2400	0.08	870	0.11	4	1725
2CL2025	C.C.W.	20	25	3000	0.1	1320	0.15	4	1725
2CL2227	C.C.W.	22	27	4340	0.17	2200	0.26	4	1725

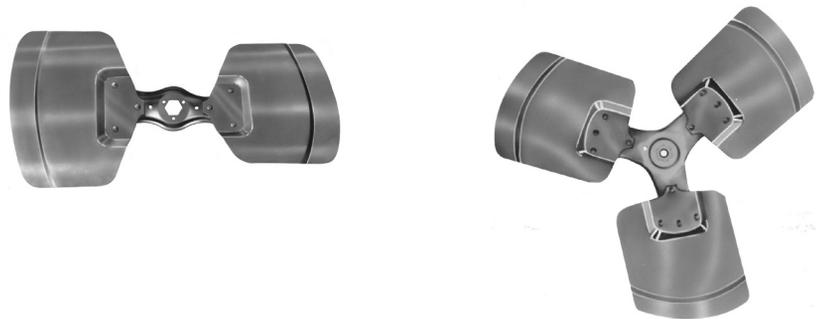

Thermally protected • UL recognized • CSA or ULc certified
NOTE: Rotation is determined by looking at shaft end. Shaft length is measured from motor face.



FEATURES

- 14 to 26 inch diameters
- High quality, heavy duty aluminum blades
- Zinc and dichromate plated steel spiders
- For use with interchangeable hubs
- Blades tested at 1000 RPM

TYPICAL APPLICATIONS

- Air-conditioning condensers
- Heat pumps
- Power roof ventilators
- Industrial equipment
- Unit heaters
- Heat exchangers

FOUR BLADE									
MODEL	FAN			STATIC PRESSURE				STD PACK	MAX RPM
	ROTATION	DIA (IN)	PITCH (DEG)	0"		.30"			
				CFM	BHP	CFM	BHP		
4CR1423	C.W.	14	23	1000	0.04	400	0.06	2	1725
4CL1423	C.C.W.			1320	0.07	670	0.1		
4CR1433	C.W.		33	1630	0.09	1030	0.12		
4CL1433	C.C.W.			2550	0.15	1450	0.18		
4CR1623	C.W.	16	23	1630	0.09	1030	0.12	2	1725
4CL1623	C.C.W.			2550	0.15	1450	0.18		
4CR1633	C.W.		33	2490	0.12	1510	0.18		
4CL1633	C.C.W.			2950	0.17	1870	0.23		
4CR1827	C.W.	18	27	2490	0.12	1510	0.18	2	1725
4CL1827	C.C.W.			2950	0.17	1870	0.23		
4CR1833	C.W.		33	3540	0.24	2580	0.32		
4CL1833	C.C.W.			3920	0.29	2290	0.35		
4CR2026	C.W.	20	26	3540	0.24	2580	0.32	2	1725
4CL2026	C.C.W.			4350	0.35	3270	0.41		
4CR2029	C.W.		29	4100	0.25	3100	0.37		
4CL2033	C.C.W.			4840	0.28	3640	0.37		
4CR2223	C.W.	22	23	4100	0.25	3100	0.37	2	1140
4CL2227	C.C.W.			5940	0.47	4470	0.57		
4CR2235	C.W.		35	4500	0.25	3500	0.25		
4CL2235	C.C.W.			5400	0.35	4600	0.45		
4CR2418	C.W.	24	18	4500	0.25	3500	0.25	2	1140
4CR2423	C.W.			6360	0.45	5280	0.63		
4CL2423	C.C.W.		27	7600	0.64	6190	0.87		
4CR2427	C.C.W.			7600	0.64	6690	0.8		
4CR2433	C.W.	33	7600	0.64	6690	0.8	2	1140	
4CR2627	C.W.		8950	0.91	7810	1.1			
4CR2633	C.W.	33	8950	0.91	7810	1.1	2	1140	





FEATURES

- 14 to 24 inch diameters
- High quality, heavy duty aluminum blades
- Factory balanced, 1/2" bore, shaved and staked hub-attached on intake side
- Blades tested at 1000 RPM

TYPICAL APPLICATIONS

- Air-conditioning condensers
- Power roof ventilators
- Heat pumps
- Heat exchangers
- Unit heaters
- Exhaust fans

THREE BLADE									
MODEL	FAN			STATIC PRESSURE				STD PACK	MAX RPM
	ROTATION	DIA (IN)	PITCH (DEG)	0"		.30"			
				CFM	BHP	CFM	BHP		
3CR1833-4	C.W.	18	33	2830	0.14	1620	0.21	4	1725
3CR2033-4	C.W.	20	33	4070	0.26	2830	0.33	4	1140

FOUR BLADE									
MODEL	FAN			STATIC PRESSURE				STD PACK	MAX RPM
	ROTATION	DIA (IN)	PITCH (DEG)	0"		.30"			
				CFM	BHP	CFM	BHP		
4CR1433-4	C.W.	14	33	1320	0.07	670	0.10	4	1725
4CR1633-4	C.W.	16	33	2550	0.15	1450	0.18	4	1725
4CR1833-4	C.W.	18	33	2950	0.17	1870	0.23	4	1725
4CR2033-4	C.W.	20	33	4350	0.35	3270	0.42	4	1140
4CL2033-4	C.C.W.								
4CR2233-4	C.W.	22	33	5670	0.41	4290	0.51	4	1140
4CR2433-4	C.W.	24	33	7600	0.64	6190	0.87	4	1140



NOTE: Thermally protected • UL recognized • CSA or ULc certified
 Rotation is determined by looking at shaft end. Shaft length is measured from motor face.



FEATURES

- 7 to 10 inch diameters
- High quality aluminum blades
- CW fans have hub attached on discharge side
- CCW fans have hub attached on intake side
- Zinc and chromate coated steel hub
- Blades tested at 1000 RPM

TYPICAL APPLICATIONS

- Freezers
- Heaters
- Refrigerators

5 BLADE, FIXED HUB									
MODEL	FAN					0" STATIC PRESSURE		STD PACK	MAX RPM
	ROTATION	DIA (IN)	PITCH (DEG)	BORE (IN.)	MAX RPM	CFM	BHP		
	5FR727-1	C.W.	7	28	1/4	3450	450		
5FL727-1	C.C.W.	7	28	1/5	3450	450	0.05	10	3450
5FR727-2	C.W.	7	28	5/16	3450	450	0.05	10	3450
5FL727-2	C.C.W.	7	28	5/17	3450	450	0.05	10	3450
5FR824-1	C.W.	8	24	1/4	3450	620	0.07	10	3450
5FL824-1	C.C.W.	8	24	1/5	3450	620	0.07	10	3450
5FR824-2	C.W.	8	24	5/16	3450	620	0.07	10	3450
5FL824-2	C.C.W.	8	24	5/17	3450	620	0.07	10	3450
5FR832-1	C.W.	8	32	1/4	3450	750	0.11	10	3450
5FL832-1	C.C.W.	8	32	1/5	3450	750	0.11	10	3450
5FR832-2	C.W.	8	32	5/16	3450	750	0.11	10	3450
5FL832-2	C.C.W.	8	32	5/17	3450	750	0.11	10	3450
5FR926-1	C.W.	9	25	1/4	3000	800	0.09	10	3000
5FL926-1	C.C.W.	9	25	1/5	3000	800	0.09	10	3000
5FR926-2	C.W.	9	25	5/16	3000	800	0.09	10	3000
5FL926-2	C.C.W.	9	25	5/17	3000	800	0.09	10	3000
5FR1020-1	C.W.	10	22	1/4	1725	550	0.02	10	1725
5FL1020-1	C.C.W.	10	22	1/5	1725	550	0.02	10	1725
5FR1020-2	C.W.	10	22	5/16	1725	550	0.02	10	1725
5FL1020-2	C.C.W.	10	22	5/17	1725	550	0.02	10	1725
5FR1031-2	C.W.	10	33	5/16	1725	740	0.04	10	1725
5FL1031-2	C.C.W.	10	33	5/17	1725	740	0.04	10	1725

5 BLADE, HUBLESS									
MODEL	FAN					0" STATIC PRESSURE		STD PACK	MAX RPM
	ROTATION	DIA (IN)	PITCH (DEG)	BORE (IN.)	MAX RPM	CFM	BHP		
	5FR1023	C.W.	10	23	1/4	1550	525		
5FR721	C.W.	7	21	1/4	1550	300	0.01	10	1550
5FR823	C.W.	8	23	1/4	1550	400	0.01	10	1550
5FR925	C.W.	9	25	1/4	1550	500	0.01	10	1550
5FR1028	C.W.	10	28	1/4	1550	700	0.02	10	1550



SINGLE INLET						
PART NUMBER	DIAMETER	WIDTH	ROTATION	BORE	MAX RPM	STD PACK
1-6123	4	7/8	C.W.	5/16	3600	4
1-6038	3	1 7/8	C.W.	1/4	5000	4
1-6039	3	1 7/8	C.C.W.	1/4	5000	4
1-6040	3 13/16	1 7/8	C.C.W.	1/4	5000	4
1-6041	3 13/16	1 7/8	C.W.	1/4	5000	4
1-6042	3 13/16	1 7/8	C.C.W.	5/16	5000	4
1-6043	3 13/16	1 7/8	C.W.	5/16	5000	4
1-6044	3 13/16	2 1/2	C.W.	5/16	5000	4
1-6045	3 13/16	2 1/2	C.C.W.	5/16	5000	4
1-6114	3 27/32	1 1/4	C.W.	1/4	5600	4
1-6113	3 27/32	1	C.W.	1/4	5800	4
1-6051	3 27/32	1 13/64	C.C.W.	1/4	5640	4
1-6141	4	1 1/2	C.C.W.	5/16	3600	4
1-6133	4	2 1/2	C.C.W.	1/4	3600	3
1-6046	4 1/4	2	C.C.W.	1/4	4500	4
1-6047	4 1/4	2	C.C.W.	5/16	4500	4
1-6052	4 1/4	2 15/16	C.C.W.	1/4	4500	3
1-6160	4 17/32	1 1/4	C.W.	5/16	6300	4
1-6161	4 17/32	1 1/4	C.C.W.	5/16	6300	4
1-6048	4 23/32	2 15/16	C.W.	5/16	3600	3
1-6000	4 23/32	2 15/16	C.C.W.	5/16	3600	3
1-6024	5 13/64	2 1/2	C.W.	5/16	3600	4
1-6025	5 13/64	2 1/2	C.C.W.	5/16	3600	4
1-6053	5 13/64	2 29/32	C.W.	5/16	3600	3
1-6054	5 13/64	2 29/32	C.C.W.	5/16	3600	3

SINGLE INLET						
PART NUMBER	DIAMETER	WIDTH	ROTATION	BORE	MAX RPM	STD PACK
1-6143	5 3/4	1 1/2	C.C.W.	5/16	3600	4
1-6026	5 45/64	2 15/16	C.C.W.	5/16	3000	3
1-6002	5 45/64	4	C.W.	1/2	2800	2
1-6057	5 45/64	4	C.C.W.	1/2	2800	2
1-6058	6	3 1/4	C.W.	1/2	2400	3
1-6010	6	3 1/4	C.C.W.	1/2	2400	3
1-6060	6 3/16	2 15/16	C.C.W.	3/8	3000	3
1-6063	6 25/64	4	C.W.	1/2	1700	2
1-6064	6 25/64	4	C.C.W.	1/2	1700	2
1-6066	7 1/8	2	C.C.W.	5/16	2900	4
1-6005	7 1/8	4	C.C.W.	1/2	1500	2
1-6070	7 31/64	3 1/2	C.W.	1/2	1800	3
1-6071	7 31/64	3 1/2	C.C.W.	1/2	1800	3
1-6006	8 5/64	4	C.W.	1/2	1650	3
1-6074	8 5/64	4	C.C.W.	1/2	1650	3
1-6077	8 35/64	3	C.C.W.	1/2	2050	4
1-6076	8 35/64	3	C.W.	1/2	2050	4
1-6007	9 1/8	4 1/4	C.W.	1/2	1475	3
1-6078	9 1/8	4 1/4	C.C.W.	1/2	1475	3
1-6008	9 1/8	5	C.W.	1/2	1350	2
1-6009	9 1/8	5	C.C.W.	1/2	1350	2
1-6079	9 31/32	4	C.W.	1/2	1350	3
1-6080	9 31/32	4	C.C.W.	1/2	1350	3
1-6027	9 31/32	6	C.W.	1/2	1100	2
1-6028	9 31/32	6	C.C.W.	1/2	1100	2

TYPICAL APPLICATIONS

- Condensers
- Small appliances
- Furnaces
- Draft booster
- Flue exhaust
- Galvanized steel

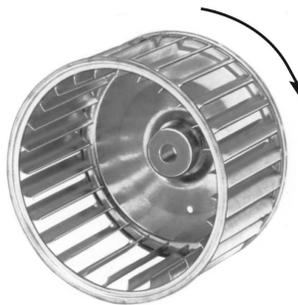

Rotation viewed side opposite hub.

Thermally protected • UL recognized • CSA or ULc certified
NOTE: Rotation is determined by looking at shaft end. Shaft length is measured from motor face.

TYPICAL APPLICATIONS

- Condensers
- Small appliances
- Furnaces
- Galvanized steel except 2-6033 and 2-6034 are aluminum

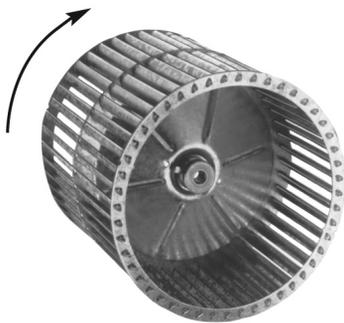

Rotation viewed hub side.

DOUBLE INLET						
PART NUMBER	DIAMETER	WIDTH	ROTATION	BORE	MAX RPM	STD PACK
2-6011	4 27/32	7	C.W.	1/2	3600	1
2-6029	4 27/32	7	C.C.W.	1/2	3600	1
2-6082	5 13/32	6 55/64	C.C.W.	3/8	3600	1
2-6030	5 1/4	6 7/8	C.W.	1/2	3600	1
2-6012	5 19/64	7	C.C.W.	1/2	3600	1
2-6013	5 9/16	6 1/2	C.W.	1/2	2500	1
2-6014	5 9/16	6 1/2	C.C.W.	1/2	2500	1
2-6031	5 45/64	7 5/8	C.W.	1/2	3000	1
2-6032	5 45/64	7 5/8	C.C.W.	1/2	3000	1
2-6033	5 3/4	7 5/8	C.W.	1/2	1700	1
2-6083	6 25/64	7	C.W.	1/2	2050	1
2-6015	6 25/64	7	C.C.W.	1/2	2050	1
2-6084	6 3/16	7 5/8	C.W.	1/2	3000	1
2-6085	6 3/16	7 5/8	C.C.W.	1/2	3000	1
2-6034	6 25/64	8	C.W.	1/2	1500	1
2-6139	6 25/64	6 1/4	C.C.W.	3/4	2275	1
2-6086	7 31/64	4	C.W.	3/4	2700	2
2-6087	7 31/64	4	C.C.W.	3/4	2700	2
2-6035	7 31/64	4 1/2	C.W.	3/4	2400	2
2-6036	7 31/64	4 1/2	C.C.W.	3/4	2400	2
2-6016	7 31/64	6	C.W.	3/4	1950	2
2-6017	7 31/64	6	C.C.W.	3/4	1950	2
2-6018	7 31/64	9	C.W.	1/2	1600	1
2-6089	9 1/2	6	C.W.	1/2	1750	2
2-6019	9 1/2	7	C.W.	1/2	1550	1
2-6090	9 1/2	8	C.W.	1/2	1400	1
2-6020	9 1/2	9 1/4	C.W.	1/2	1300	1
2-6092	10 25/32	6	C.W.	1/2	1550	2
2-6093	10 25/32	7	C.W.	1/2	1350	2
2-6021	10 25/32	7 3/4	C.W.	1/2	1250	1
2-6037	10 25/32	9 1/4	C.W.	1/2	1200	1
2-6022	10 25/32	10 1/2	C.W.	1/2	1150	1



FAN BLADE ACCESSORIES

HEX HUB FEATURES

- Sizes to fit most applications
- Simple screw design
- Zinc plated steel
- Pre-tapped holes with mounting and set screws started



INTERCHANGEABLE HEX HUBS		
PART NO.	BORE	NO. SET SCREWS
H5	5/16	1
H6	3/8	1
H8	1/2	2
H10	5/8	2

Packaged 12 per carton.

BUSHING FEATURES

- Two bolt design
- Two 1/4-20 x 3/4" cap screws provided
- Malleable iron construction
- For 1/2"-13/8" bore ranges



SPLIT TAPERED BUSHINGS "H" SERIES	
PART NO.	BORE
STB1	1/2
STB2	5/8
STB3	3/4
STB4	7/8
STB5	1
STB6	1 1/8
STB7	1 3/16
STB8	1 3/8

Packaged one per kit.

BAND MOUNTING KITS

PART NO.	MOTOR DIA.	LUG SIZE	BOLT CIRCLE RANGE
N055L	5.5"	Large	8 1/8 - 12 1/8
N055S	5.5"	Small	6 7/8 - 8 1/8
KIT34	3.3"	Large	4 11/16 - 9 7/8
KIT50	5.0"	Large	6 7/16 - 11 11/16
KIT49	3 small lugs for Kit 55S		
KIT150	4 grommets to fit lugs on Kits 34, 49, 50, 55L, 55S		
N050L	4.4" & 5.0"	Large	6 1/2 - 11 8/16
N033L	3.3"	Large	4 1/2 - 10
KIT315	5.0"	Large	9.8
KIT317	5.6"	Large	9.8



N055L, N055S, KIT34, KIT50

KIT150

KIT49



N050L, N033L

KIT315, KIT317

FAS MOUNT BRACKET KITS

FM50

Motor diameter 5.0"
Bolt circle 9" and 10.18"



FM55

Motor diameter 5.5"
Bolt circle 9" and 10.18"



FM554

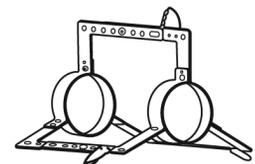

FM55 replaces this type bracket

These kits are designed for direct drive blower motors using the flexible bracket mounting arrangement.

Grommets and eyelets are included.

Thermally protected • UL recognized • CSA or ULc certified
NOTE: Rotation is determined by looking at shaft end. Shaft length is measured from motor face.



CONDUIT BOXES

KIT142

Black box for 3.3" diameter motors.

Packaged one per kit.

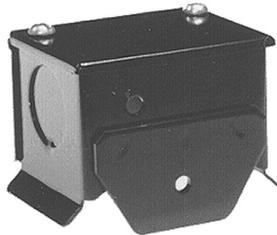

KIT144

Gray, tie-rod mountable box for 4.4", 5.0" and 5.6" diameter motors.

Packaged one per kit.



CONDUIT KITS

KIT100

For 5/16" and 3/8" Greenfield (flexible conduit).

Packaged two per kit.



KIT102

3/8" conduit connector Allen Stevens type, complete with mounting screws.

Packed three per kit.

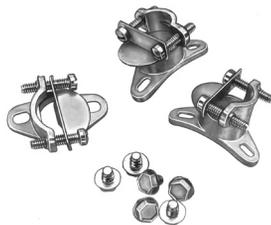

BLOWER ACCESSORIES

INLET SCREENS

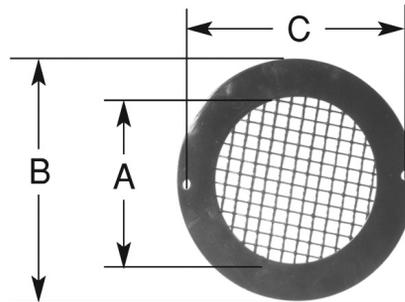

4004
A = 3.125
B = 4.50
C = 4.188

4000
A = 4.72
B = 6.125
C = 5.75

INLET4004

For Air Rotors of less than 3 7/8" diameter, Inlet 4004 can be used on the following blowers:

50746-D500, 50747-D230, 50747-D401, 50747-D500, 50747-D600, 50748-D500, 50748-D700, 50752-D230, 50752-D500, A069, A071, A073, A075, A081, A083, B23617 or B23618

Packaged one per kit.

INLET4000

For Air Rotors of less than 4" to 5 1/2" diameter, Inlet 4000 can be used on the

following blowers:

50755-D230, 50755-D500, 50756-D230, 50756-D500, 50757-D500, A159 or A161

Packaged one per kit.

FLANGES

KIT280

Meeting hole diameter .281"
Packaged one per kit.



KIT282

Meeting hole diameter .136"
Packaged one per kit.



KIT284

Packaged one per kit.

RESILIENT MOTOR BASES											
FASCO MODEL	RECOMM. BASE	FASCO MODEL	RECOMM. BASE	FASCO MODEL	RECOMM. BASE	FASCO MODEL	RECOMM. BASE	FASCO MODEL	RECOMM. BASE	FASCO MODEL	RECOMM. BASE
D112	517*	D337	435	D701	595	D812	492	D937	461	D1748	461
D117	386	D338	492	D703	558	D816	461	D939	461	D1749	461
D148	354	D339	492	D711	595	D818	705*	D940	595*	D1853	492
D150	492*	D347	386	D721	461	D821	542	D951	595*	D1910	595
D151	492*	D356	417	D723	517	D823	595	D966	517*	D1911	558
D152	492*	D435	517*	D725	461	D825	705	D967	558	D2700	595
D154	558	D474	542	D726	558*	D838	595	D968	595	D2701	558
D156	479*	D480	542	D727	479	D860	595	D970	595	D2702	595*
D158	479*	D481	542	D728	595	D870	542	D971	542	D2703	595*
D160	479*	D482	492	D729	595	D896	435	D972	492	D2704	595*
D164	479*	D483	492	D730	595	D897	435	D973	461	D2705	705*
D166	479*	D484	492	D733	492	D902	595	D974	595	D2814	595*
D174	417	D485	492	D735	595	D910	595	D975	461	D2816	NONE
D176	354*	D486	517*	D737	517	D911	558	D1016	479	D2817	595*
D178	417	D487	517*	D739	492	D912	479	D1025	492	D2818	NONE
D236	435	D488	517	D745	517	D913	479	D1033	479	D2832	595*
D253	354	D489	542	D748	492	D914	595	D1042	492	D2833	595
D260	479	D490	558	D780	517	D915	595	D1046	386	D7745	517
D261	461	D491	558	D782	492	D916	595	D1051	408	D7748	492
D264	408*	D492	558	D783	461	D918	479	D1061	492	D7749	435
D312	492	D493	558	D784	558	D920	595	D1065	408*	S2846	705
D314	517*	D494	492	D785	542	D923	492	D1086	435	S2848	NONE
D316	461*	D495	492	D786	595	D927	435	D1089	435	S156	435
D329	435	D497	542	D787	492	D928	435	D1246	435		
D333	386*	D635	435	D788	558	D929	558*	D1709	595*		
D335	408	D656	479	D789	592	D930	558*	D1710	705*		
D336	435	D658	479	D807	435	D935	558	D1745	558		

* May need to reverse one or more mounting rings

CRADLE BASE "B" DIMENSION	3-1/2" BASE NO.	3" BASE NO.
3.54	35-354	30-354
3.86	35-386	30-386
4.08	35-408	30-408
4.17	35-417	-
4.35	35-435	30-435
4.61	35-461	30-461
4.79	35-479	30-479
4.92	35-492	30-492
5.17	35-517	30-517
5.42	35-542	30-542
5.58	35-558	30-558
5.95	35-595	30-595
7.05	35-705	30-705

NOTE: The current base numbering system uses the first two numbers to indicate shaft height (30 is 3.0" and 35 is 3.5") and the last three numbers represent distance between cradle arms (386 is 3.86" etc.). Example: 35-417 has a 3.5" shaft height and 4.17" cradle base. To achieve the shaft height listed, the 2 1/2" diameter rings must be used.

For motors not listed: Add .8 to a "A" dimension of 4 7/16" diameter motors for base "B" dimension. Add .9 to "A" dimension of 5" diameter motors for base "B" dimension. Add .5 to "A" dimension of 5 5/8" diameter motors for base "B" dimension.



CLAMP6004

Extra base clamps.

Two base clamps ship with each base.

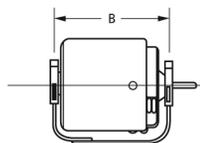

Specify shaft height 3.00" or 3.50" and motor model.

Thermally protected • UL recognized • CSA or ULc certified

NOTE: Rotation is determined by looking at shaft end. Shaft length is measured from motor face.

FOR 3.3" DIAMETER MOTORS

KIT216

Special end plate for 3.3" diameter motors for base mounting. Use with KIT180 mounting cups. Packaged one per kit.



FOR SHAFT END OF 48 FRAME MOTORS

SHLD6303

Ventilated with double oiling hub 1/2" Sleeve Bearing.



KIT225

Triangular bracket with grommets for 3.3" diameter motors. Packaged one per kit.



SHLD6311

Ventilated with flat face 5/8" Sleeve Bearing.



MOUNTING CUP

KIT265

Used to mount 3.3" motors to some blower housings. Packaged one per kit.

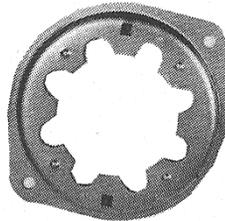

SHLD6302

Non-Ventilated with double oiling hub 1/2" Sleeve Bearing.



FOR SHAFT END OF 48 FRAME MOTORS

SHLD6301

Ventilated with flat face 1/2" Sleeve Bearing.



SHLD6304

Non-Ventilated with flat face 1/2" Sleeve Bearing.



SHLD6312

Non-Ventilated with flat face 5/8" Sleeve Bearing.



KIT410

End Shield caps for 48 frame. 10 per kit (5 open, 5 closed).



MOUNTING KITS

KIT200

Holes for 4.4" and 5.6" diameter motors.
One kit will adapt both ends of motor for base mounting.



ADAPTER PLATES

KIT207

Provides rectangular mounting stud pattern on 5.0" or 5.6" diameter Fasco motors to match Fedders stud motors.
Similar to Emerson and RMR rectangular mounting stud patterns.
Packaged one per kit.

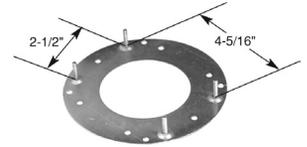

KIT199

Motor length adapter kit.
Provides means to base mount Fasco 5" diameter motors.
Two kits needed to adapt both ends of motor for base mounting.



KIT205

Franklin Redmond 4 1/8" diameter mounting adapter plate.
Packaged one per kit.



KIT380

Rheem mounting adapter plate.
Packaged one per kit.



ADAPTER KITS

H33

Special mounting kit for 3.3" diameter to replace motors in Nu-tone units.
Includes four nuts and two hex hub brackets.
Use KIT187 mounting rings.



KIT214

Special end plate for 3.3" diameter motor.
Packaged one per kit.



KIT414

Adjustable casebolt mounting kit.
Four bolt adapters per kit.



KIT218

Aluminum stand-off bracket for motor-blower mounting.
Matches 3.3" mounting pattern.
KIT214 required to mount to motor.
Packaged one per kit.



Thermally protected • UL recognized • CSA or ULc certified
NOTE: Rotation is determined by looking at shaft end. Shaft length is measured from motor face.



MOUNTING ADAPTER KITS & PARTS

RHEEM MOUNTING CABLES

PART NO.	LENGTH	MOTOR H.P.
KIT325	3-1/4	1/6
KIT350	3-1/2	1/4
KIT378	3-1/8	1/3

Special mounting cables for Rheem. Four per pkg.



COLEMAN "LORD" MOUNT

KIT208

Studs: 3/8" x 8-32 x 3/8"
Bushing: 1/2" x 1/2"
Four per kit.



MNT1518

Stud: 1/4 x 8-32
Hole: 1/4 x 8-32
Bushing: 1/2 x 1/2
Shipped individually.

MOUNTING GROMMETS

GROM6008

For 3/4" slot.
Shipped individually.
Includes a Steel Sleeve

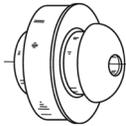

GROM6000

For 1/2" slot.
Shipped individually.

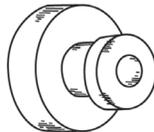

RUBBER MOUNTING RINGS

FOR 5.6", 5.0" AND 4.4" DIAMETER MOTORS

KIT184

Henrite 2.50
Packaged two per kit.



KIT183

Henrite 2.25 O.D.
Packaged two per kit.



KIT186

All Rubber 2.50 O.D.
Packaged two per kit.



FOR 3.3" DIAMETER MOTORS

KIT180

Henrite 1.80 O.D.
Packaged two per kit.



KIT187

Rubber mounting rings; use with H33 in Nutone and Broan applications.
Packaged two per kit.



Henrite are rubber mounting rings with steel band, used with cradle bases and knife edge motor supports.

All Rubber rings are used with direct drive blower motors and "Clamp" type supports.

CAPACITOR MOUNTING KIT

KIT6001

Rubber boot and bracket.

RUBBERBOOT

Rubber boot sold separately.



STAKED TIE RODS QTY. 4

KIT220

8" long 8-32 NC for Fasco 5.6" diameter motors.
Includes one staked nut and one regular nut.

KIT221

8" long 10-32 NC for Fasco 4.4" diameter motors.



KIT832

8-32 Nuts, 32 pieces



KIT1032

10-32 Nuts, 32 pieces



NEOPRENE GASKET

GASKET0167

Includes one gasket and four grommets.
3.3" diameter motors
2.84" Bolt Circle diameter

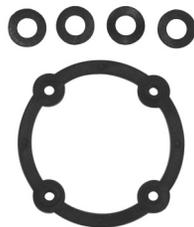

SHAFT BUSHINGS QTY. 4

KIT240

1/4" ID x 5/16" OD

KIT242

3/8" ID x 1/2" OD

KIT244

5/16" ID x 3/8" OD

KIT246

1/2" ID x 5/8" OD



KIT465

Anderol 465 synthetic lubricating oil (3 oz.).
Packaged one per carton.



WATER SLINGER

SLINGR6002

1/2" ID x 2" OD
Shipped individually.



RAIN SHIELDS

KIT170

For 1/2" shaft diameter motors.

RAIN6000

For 5/8" shaft diameter motors.

RAIN6017

RAIN6018



COOLING FAN KIT FOR DRAFT

BOOSTER MOTORS

FK100

C.W. rotation
1 3/4" diameter
1/4" Hub ID

FK101

C.C.W. rotation
1 3/4" diameter
1/4" Hub ID

Shipped one fan per kit.



Rotation is facing side
opposite hub

Thermally protected • UL recognized • CSA or ULc certified
NOTE: Rotation is determined by looking at shaft end. Shaft length is measured from motor face.



- * Delivers 10,000 hrs of reliable performance
- * Quality design exceeds IEC-252 Class B Industry Reliability Standards
- * Patented "Safe Failure System"
- * Manufactured in North America by Regal Beloit Corporation
- * Over 50+ years of manufacturing and engineering experience
- * -40°C to 70°C operating temperature

370 VAC - OVAL - MOTOR RUN CAPACITORS

FASCO MODEL	UF1	VOLTS		BASE SIZE	CAN TYPE	CASE HEIGHT
C3S2	2.0	370	AC	1.25	OVAL	1.56
C3S3	3.0	370	AC	1.25	OVAL	1.56
C3S4	4.0	370	AC	1.25	OVAL	1.56
C3S5	5.0	370	AC	1.25	OVAL	1.56
C3S6	6.0	370	AC	1.25	OVAL	2.12
C3S7.5	7.5	370	AC	1.25	OVAL	2.12
C3S10	10.0	370	AC	1.25	OVAL	2.88
C3S12.5	12.5	370	AC	1.25	OVAL	2.88
C3S15	15.0	370	AC	1.25	OVAL	2.88

FASCO MODEL	UF1	VOLTS		BASE SIZE	CAN TYPE	CASE HEIGHT
C3S17.5	17.5	370	AC	1.25	OVAL	3.88
C3S20	20.0	370	AC	1.25	OVAL	3.88
C3S25	25.0	370	AC	1.25	OVAL	3.88
C3S30	30.0	370	AC	1.25	OVAL	4.75
C3S35	35.0	370	AC	1.25	OVAL	4.75
C3S40	40.0	370	AC	1.75	OVAL	3.88
C3S45	45.0	370	AC	1.75	OVAL	3.88
C3S50	50.0	370	AC	1.75	OVAL	3.88
C3S60	60.0	370	AC	1.75	OVAL	4.75

440 VAC - OVAL - MOTOR RUN CAPACITORS

FASCO MODEL	UF1	VOLTS		BASE SIZE	CAN TYPE	CASE HEIGHT
C4S5	5.0	440	AC	1.25	OVAL	2.12
C4S7.5	7.5	440	AC	1.25	OVAL	2.88
C4S10	10.0	440	AC	1.25	OVAL	2.88
C4S12.5	12.5	440	AC	1.25	OVAL	3.88
C4S15	15.0	440	AC	1.25	OVAL	4.75
C4S17.5	17.5	440	AC	1.25	OVAL	4.75
C4S20	20.0	440	AC	1.25	OVAL	4.75

FASCO MODEL	UF1	VOLTS		BASE SIZE	CAN TYPE	CASE HEIGHT
C4S25	25.0	440	AC	1.25	OVAL	4.75
C4S30	30.0	440	AC	1.75	OVAL	3.88
C4S35	35.0	440	AC	1.75	OVAL	3.88
C4S40	40.0	440	AC	1.75	OVAL	3.88
C4S45	45.0	440	AC	1.75	OVAL	4.75
C4S50	50.0	440	AC	1.75	OVAL	4.75
C4S60	60.0	440	AC	2.00	OVAL	4.25

370 VAC - ROUND - MOTOR RUN CAPACITORS

FASCO MODEL	UF1	VOLTS		BASE SIZE	CAN TYPE	CASE HEIGHT
C3RS5	5.0	370	AC	1.75	ROUND	2.88
C3RS7.5	7.5	370	AC	1.75	ROUND	2.88
C3RS10	10.0	370	AC	1.75	ROUND	2.88
C3RS15	15.0	370	AC	1.75	ROUND	2.88
C3RS17.5	17.5	370	AC	1.75	ROUND	2.88
C3RS20	20.0	370	AC	1.75	ROUND	2.88
C3RS25	25.0	370	AC	1.75	ROUND	2.88
C3RS30	30.0	370	AC	1.75	ROUND	3.88

FASCO MODEL	UF1	VOLTS		BASE SIZE	CAN TYPE	CASE HEIGHT
C3RS35	35.0	370	AC	1.75	ROUND	3.88
C3RS40	40.0	370	AC	1.75	ROUND	3.88
C3RS45	45.0	370	AC	1.75	ROUND	4.75
C3RS50	50.0	370	AC	1.75	ROUND	4.75
C3RS55	55.0	370	AC	1.75	ROUND	4.75
C3RS60	60.0	370	AC	1.75	ROUND	4.75
C3RS70	70.0	370	AC	2.50	ROUND	4.75
C3RS80	80.0	370	AC	2.50	ROUND	4.75

440 VAC - ROUND - MOTOR RUN CAPACITORS

FASCO MODEL	UF1	VOLTS		BASE SIZE	CAN TYPE	CASE HEIGHT
C4RS5	5.0	440	AC	1.75	ROUND	2.88
C4RS7.5	7.5	440	AC	1.75	ROUND	2.88
C4RS10	10.0	440	AC	1.75	ROUND	2.88
C4RS12.5	12.5	440	AC	1.75	ROUND	2.88
C4RS15	15.0	440	AC	1.75	ROUND	2.88
C4RS20	20.0	440	AC	1.75	ROUND	2.88
C4RS25	25.0	440	AC	1.75	ROUND	3.88
C4RS30	30.0	440	AC	1.75	ROUND	3.88

FASCO MODEL	UF1	VOLTS		BASE SIZE	CAN TYPE	CASE HEIGHT
C4RS35	35.0	440	AC	2.00	ROUND	3.88
C4RS40	40.0	440	AC	1.75	ROUND	4.75
C4RS45	45.0	440	AC	2.00	ROUND	3.88
C4RS50	50.0	440	AC	2.00	ROUND	5.75
C4RS55	55.0	440	AC	2.50	ROUND	4.75
C4RS60	60.0	440	AC	2.50	ROUND	4.75
C4RS70	70.0	440	AC	2.50	ROUND	4.75
C4RS80	80.0	440	AC	2.50	ROUND	5.75

370 VAC - DUAL - OVAL MOTOR RUN CAPACITORS

FASCO MODEL	UF1	UF2	VOLTS		BASE SIZE	CAN TYPE	CASE HEIGHT
C3D1010	10.0	10.0	370	AC	1.75	OVAL	2.12
C3D155	15.0	5.0	370	AC	1.75	OVAL	2.88
C3D157.5	15.0	7.5	370	AC	1.75	OVAL	2.88
C3D1510	15.0	10.0	370	AC	1.75	OVAL	2.88
C3D205	20.0	5.0	370	AC	1.75	OVAL	2.88
C3D207.5	20.0	7.5	370	AC	1.75	OVAL	2.88
C3D2010	20.0	10.0	370	AC	1.75	OVAL	3.88
C3D255	25.0	5.0	370	AC	1.75	OVAL	2.88
C3D257.5	25.0	7.5	370	AC	1.75	OVAL	2.88
C3D2510	25.0	10.0	370	AC	1.75	OVAL	2.88
C3D305	30.0	5.0	370	AC	1.75	OVAL	3.88
C3D307.5	30.0	7.5	370	AC	1.75	OVAL	3.88
C3D3010	30.0	10.0	370	AC	1.75	OVAL	3.88

FASCO MODEL	UF1	UF2	VOLTS		BASE SIZE	CAN TYPE	CASE HEIGHT
C3D355	35.0	5.0	370	AC	1.75	OVAL	3.88
C3D357.5	35.0	7.5	370	AC	1.75	OVAL	3.88
C3D3510	35.0	10.0	370	AC	1.75	OVAL	3.88
C3D405	40.0	5.0	370	AC	1.75	OVAL	3.88
C3D407.5	40.0	7.5	370	AC	1.75	OVAL	3.88
C3D4010	40.0	10.0	370	AC	1.75	OVAL	3.88
C3D455	45.0	5.0	370	AC	1.75	OVAL	3.88
C3D457.5	45.0	7.5	370	AC	1.75	OVAL	3.88
C3D4510	45.0	10.0	370	AC	1.75	OVAL	3.88
C3D505	50.0	5.0	370	AC	1.75	OVAL	4.75
C3D507.5	50.0	7.5	370	AC	1.75	OVAL	4.75
C3D5010	50.0	10.0	370	AC	2.00	OVAL	4.75

440 VAC - DUAL - OVAL MOTOR RUN CAPACITORS

FASCO MODEL	UF1	UF2	VOLTS		BASE SIZE	CAN TYPE	CASE HEIGHT
C4D1010	10.0	10.0	440	AC	1.75	OVAL	2.88
C4D155	15.0	5.0	440	AC	1.75	OVAL	2.88
C4D157.5	15.0	7.5	440	AC	1.75	OVAL	2.88
C4D1510	15.0	10.0	440	AC	1.75	OVAL	3.88
C4D205	20.0	5.0	440	AC	1.75	OVAL	2.88
C4D207.5	20.0	7.5	440	AC	1.75	OVAL	3.88
C4D2010	20.0	10.0	440	AC	1.75	OVAL	3.88
C4D255	25.0	5.0	440	AC	1.75	OVAL	3.88
C4D257.5	25.0	7.5	440	AC	1.75	OVAL	3.88
C4D2510	25.0	10.0	440	AC	1.75	OVAL	4.75
C4D305	30.0	5.0	440	AC	1.75	OVAL	3.88
C4D307.5	30.0	7.5	440	AC	1.75	OVAL	3.88
C4D3010	30.0	10.0	440	AC	1.75	OVAL	4.75

FASCO MODEL	UF1	UF2	VOLTS		BASE SIZE	CAN TYPE	CASE HEIGHT
C4D355	35.0	5.0	440	AC	1.75	OVAL	4.75
C4D357.5	35.0	7.5	440	AC	1.75	OVAL	4.75
C4D3510	35.0	10.0	440	AC	1.75	OVAL	4.75
C4D405	40.0	5.0	440	AC	1.75	OVAL	4.75
C4D407.5	40.0	7.5	440	AC	1.75	OVAL	4.75
C4D4010	40.0	10.0	440	AC	2.00	OVAL	4.75
C4D455	45.0	5.0	440	AC	1.75	OVAL	4.75
C4D4510	45.0	10.0	440	AC	1.75	OVAL	4.75
C4D457.5	45.0	7.5	440	AC	2.00	OVAL	4.75
C4D505	50.0	5.0	440	AC	2.00	OVAL	5.25
C4D507.5	50.0	7.5	440	AC	2.00	OVAL	5.25
C4D5010	50.0	10.0	440	AC	2.00	OVAL	5.25

370 VAC - DUAL - ROUND MOTOR RUN CAPACITORS

FASCO MODEL	UF1	UF2	VOLTS		BASE SIZE	CAN TYPE	CASE HEIGHT
C3DR155	15.0	5.0	370	AC	2.00	ROUND	2.88
C3DR157.5	15.0	7.5	370	AC	2.00	ROUND	2.88
C3DR1510	15.0	10.0	370	AC	2.00	ROUND	2.88
C3DR205	20.0	5.0	370	AC	2.00	ROUND	2.88
C3DR207.5	20.0	7.5	370	AC	2.00	ROUND	2.88
C3DR2010	20.0	10.0	370	AC	2.00	ROUND	2.88
C3DR255	25.0	5.0	370	AC	2.00	ROUND	2.88
C3DR257.5	25.0	7.5	370	AC	2.00	ROUND	2.88
C3DR2510	25.0	10.0	370	AC	2.00	ROUND	2.88
C3DR305	30.0	5.0	370	AC	2.00	ROUND	2.88
C3DR307.5	30.0	7.5	370	AC	2.00	ROUND	3.88
C3DR3010	30.0	10.0	370	AC	2.00	ROUND	3.88
C3DR355	35.0	5.0	370	AC	2.00	ROUND	3.88
C3DR357.5	35.0	7.5	370	AC	2.00	ROUND	3.88
C3DR3510	35.0	10.0	370	AC	2.00	ROUND	3.88
C3DR405	40.0	5.0	370	AC	2.00	ROUND	3.88
C3DR407.5	40.0	7.5	370	AC	2.00	ROUND	3.88
C3DR4010	40.0	10.0	370	AC	2.00	ROUND	3.88

FASCO MODEL	UF1	UF2	VOLTS		BASE SIZE	CAN TYPE	CASE HEIGHT
C3DR455	45.0	5.0	370	AC	2.00	ROUND	3.88
C3DR457.5	45.0	7.5	370	AC	2.00	ROUND	3.88
C3DR4510	45.0	10.0	370	AC	2.00	ROUND	4.75
C3DR505	50.0	5.0	370	AC	2.00	ROUND	3.88
C3DR507.5	50.0	7.5	370	AC	2.00	ROUND	4.75
C3DR5010	50.0	10.0	370	AC	2.00	ROUND	4.75
C3DR555	55.0	5.0	370	AC	2.50	ROUND	3.88
C3DR557.5	55.0	7.5	370	AC	2.50	ROUND	3.88
C3DR5510	55.0	10.0	370	AC	2.50	ROUND	3.88
C3DR605	60.0	5.0	370	AC	2.50	ROUND	3.88
C3DR607.5	60.0	7.5	370	AC	2.50	ROUND	4.75
C3DR6010	60.0	10.0	370	AC	2.50	ROUND	4.75
C3DR705	70.0	5.0	370	AC	2.50	ROUND	4.75
C3DR707.5	70.0	7.5	370	AC	2.50	ROUND	4.75
C3DR7010	70.0	10.0	370	AC	2.50	ROUND	4.75
C3DR805	80.0	5.0	370	AC	2.50	ROUND	4.75
C3DR807.5	80.0	7.5	370	AC	2.50	ROUND	4.75
C3DR8010	80.0	10.0	370	AC	2.50	ROUND	4.75

Thermally protected • UL recognized • CSA or ULc certified
NOTE: Rotation is determined by looking at shaft end. Shaft length is measured from motor face.



440 VAC - DUAL - ROUND MOTOR RUN CAPACITORS

FASCO MODEL	UF1	UF2	VOLTS	BASE SIZE	CAN TYPE	CASE HEIGHT
▶ C4DR155	15.0	5.0	440	AC	2.00	ROUND 2.88
▶ C4DR157.5	15.0	7.5	440	AC	2.00	ROUND 3.88
▶ C4DR1510	15.0	10.0	440	AC	2.00	ROUND 3.88
▶ C4DR205	20.0	5.0	440	AC	2.00	ROUND 2.88
▶ C4DR207.5	20.0	7.5	440	AC	2.00	ROUND 3.88
▶ C4DR2010	20.0	10.0	440	AC	2.00	ROUND 3.88
▶ C4DR255	25.0	5.0	440	AC	2.00	ROUND 3.88
▶ C4DR257.5	25.0	7.5	440	AC	2.00	ROUND 3.88
▶ C4DR2510	25.0	10.0	440	AC	2.00	ROUND 3.88
▶ C4DR305	30.0	5.0	440	AC	2.00	ROUND 3.88
▶ C4DR307.5	30.0	7.5	440	AC	2.00	ROUND 3.88
▶ C4DR3010	30.0	10.0	440	AC	2.00	ROUND 3.88
▶ C4DR355	35.0	5.0	440	AC	2.00	ROUND 4.75
▶ C4DR357.5	35.0	7.5	440	AC	2.00	ROUND 4.75
▶ C4DR3510	35.0	10.0	440	AC	2.50	ROUND 3.88
▶ C4DR405	40.0	5.0	440	AC	2.50	ROUND 2.88
▶ C4DR407.5	40.0	7.5	440	AC	2.00	ROUND 4.75
▶ C4DR4010	40.0	10.0	440	AC	2.00	ROUND 4.75

FASCO MODEL	UF1	UF2	VOLTS	BASE SIZE	CAN TYPE	CASE HEIGHT
▶ C4DR455	45.0	5.0	440	AC	2.50	ROUND 3.88
▶ C4DR457.5	45.0	7.5	440	AC	2.50	ROUND 3.88
▶ C4DR4510	45.0	10.0	440	AC	2.50	ROUND 3.88
▶ C4DR505	50.0	5.0	440	AC	2.50	ROUND 4.25
▶ C4DR507.5	50.0	7.5	440	AC	2.50	ROUND 4.75
▶ C4DR5010	50.0	10.0	440	AC	2.50	ROUND 4.75
▶ C4DR555	55.0	5.0	440	AC	2.50	ROUND 4.75
▶ C4DR557.5	55.0	7.5	440	AC	2.50	ROUND 4.75
▶ C4DR5510	55.0	10.0	440	AC	2.50	ROUND 4.75
▶ C4DR605	60.0	5.0	440	AC	2.50	ROUND 4.75
▶ C4DR607.5	60.0	7.5	440	AC	2.50	ROUND 4.75
▶ C4DR6010	60.0	10.0	440	AC	2.50	ROUND 4.75
▶ C4DR705	70.0	5.0	440	AC	2.50	ROUND 5.25
▶ C4DR707.5	70.0	7.5	440	AC	2.50	ROUND 4.75
▶ C4DR7010	70.0	10.0	440	AC	2.50	ROUND 4.75
▶ C4DR805	80.0	5.0	440	AC	2.50	ROUND 4.75
▶ C4DR807.5	80.0	7.5	440	AC	2.50	ROUND 4.75
▶ C4DR8010	80.0	10.0	440	AC	2.50	ROUND 4.75

LIFE-LINE™ CAPACITOR KIT REPLACEMENT PARTS

Life-Line™



FEATURES

The Life-Line™ Capacitor Kit is the all in one replacement kit for your single and dual run capacitor needs.

- IEC-252 Class B Industry Reliability Standards
- UL Listed
- Convenient carrying case to keep you organized
- PROLINE™ Capacitors with over 10,000 Hrs of Reliable Performance

BENEFITS

- Save time and money by having exactly what you need on the job and ability to only use and replace what you need.
- This kit has been designed to cover over 85% of the most commonly used capacitor ratings in the field today.
- Turn six capacitors into 48 duals with no guess work using the UL approved (patent-pending Life-Line™ Device).

LCKP-001

Life-Line™ Capacitor Kit

INCLUDED in KIT:

- * 6 Best in Class Motor Run Capacitors
- * 2 Life-Line™ devices
- * 1 Capacitor Mounting Hardware Kit
- * 1 Device Mounting Hardware Kit
- * 1 Robust Carrying Case
- * Installation Guide



LCK-CID-001

Life-Line™ Device (4 pack)



LCK-SBA-001

Capacitor Mounting Hardware Kit

- * 3 adjustable brackets
- * Self tapping mounting screws



LCK-DBA-001

Device Mounting Hardware Kit

- * 3 different sizes for oval & round



New Product Listing

NEW MODEL	PAGE	NEW MODEL	PAGE	NEW MODEL	PAGE	NEW MODEL	PAGE	NEW MODEL	PAGE
A051	53, 79	C3DR505	113	C3S12.5	112	C4DR357.5	114	C4S10	112
A065	52, 76	C3DR507.5	113	C3S15	112	C4DR405	114	C4S12.5	112
A066	56, 87	C3DR555	113	C3S17.5	112	C4DR407.5	114	C4S15	112
A067	53, 79	C3DR557.5	113	C3S20	112	C4DR455	114	C4S17.5	112
A068	54, 82	C3DR605	113	C3S25	112	C4DR457.5	114	C4S20	112
B160	63	C3DR607.5	113	C3S30	112	C4DR505	114	C4S25	112
C3D155	113	C3DR705	113	C3S35	112	C4DR507.5	114	C4S30	112
C3D157.5	113	C3DR707.5	113	C3S40	112	C4DR555	114	C4S35	112
C3D205	113	C3DR805	113	C3S45	112	C4DR557.5	114	C4S40	112
C3D207.5	113	C3DR807.5	113	C3S50	112	C4DR605	114	C4S45	112
C3D255	113	C3DR1510	113	C3S60	112	C4DR607.5	114	C4S50	112
C3D257.5	113	C3DR2010	113	C4D155	113	C4DR705	114	C4S60	112
C3D305	113	C3DR2510	113	C4D157.5	113	C4DR707.5	114	D417	25
C3D307.5	113	C3DR3010	113	C4D205	113	C4DR805	114	D1129	8, 25
C3D355	113	C3DR3510	113	C4D207.5	113	C4DR807.5	114	D1130	8, 22
C3D357.5	113	C3DR4010	113	C4D255	113	C4DR1510	114	D2852	42
C3D405	113	C3DR4510	113	C4D257.5	113	C4DR2010	114	FM554	105
C3D407.5	113	C3DR5010	113	C4D305	113	C4DR2510	114	G2243	12, 34
C3D455	113	C3DR5510	113	C4D307.5	113	C4DR3010	114	G2244	12, 34
C3D457.5	113	C3DR6010	113	C4D355	113	C4DR3510	114	G2245	12, 34
C3D505	113	C3DR7010	113	C4D357.5	113	C4DR4010	114	G2246	12, 34
C3D507.5	113	C3DR8010	113	C4D405	113	C4DR4510	114	G2247	12, 34
C3D1010	113	C3RS5	112	C4D407.5	113	C4DR5010	114	G2248	12, 34
C3D1510	113	C3RS7.5	112	C4D455	113	C4DR5510	114	G2249	12, 34
C3D2010	113	C3RS10	112	C4D457.5	113	C4DR6010	114	K141	7, 20
C3D2510	113	C3RS15	112	C4D505	113	C4DR7010	114	K142	7, 20
C3D3010	113	C3RS17.5	112	C4D507.5	113	C4DR8010	114	K143	7, 20
C3D3510	113	C3RS20	112	C4D1010	113	C4RS5	112	K144	7, 20
C3D4010	113	C3RS25	112	C4D1510	113	C4RS7.5	112	K145	7, 19
C3D4510	113	C3RS30	112	C4D2010	113	C4RS10	112	K146	7, 20
C3D5010	113	C3RS35	112	C4D2510	113	C4RS12.5	112	K147	7, 20
C3DR155	113	C3RS40	112	C4D3010	113	C4RS15	112	LCK-CID-001	114
C3DR157.5	113	C3RS45	112	C4D3510	113	C4RS20	112	LCK-DBA-001	114
C3DR205	113	C3RS50	112	C4D4010	113	C4RS25	112	LCKP-001	114
C3DR207.5	113	C3RS55	112	C4D4510	113	C4RS30	112	LCK-SBA-001	114
C3DR255	113	C3RS60	112	C4D5010	113	C4RS35	112	W3	67
C3DR257.5	113	C3RS70	112	C4DR155	114	C4RS40	112		
C3DR305	113	C3RS80	112	C4DR157.5	114	C4RS45	112		
C3DR307.5	113	C3S2	112	C4DR205	114	C4RS50	112		
C3DR355	113	C3S3	112	C4DR207.5	114	C4RS55	112		
C3DR357.5	113	C3S4	112	C4DR255	114	C4RS60	112		
C3DR405	113	C3S5	112	C4DR257.5	114	C4RS70	112		
C3DR407.5	113	C3S6	112	C4DR305	114	C4RS80	112		
C3DR455	113	C3S7.5	112	C4DR307.5	114	C4S5	112		
C3DR457.5	113	C3S10	112	C4DR355	114	C4S7.5	112		

Thermally protected • UL recognized • CSA or ULc certified
NOTE: Rotation is determined by looking at shaft end. Shaft length is measured from motor face.

Notes Glossary



Below is a quick reference listing of numbers you will find in the notes column of FASCO's model charts throughout the catalog, and their respective meanings.

- 1 4M 370V capacitor
- 2 7.5M 370V capacitor not included
- 3 6M 370V capacitor
- 4 Water Heater Draft Inducer
- 5 Special low-temperature oil
- 6 Includes 4M 370V capacitor
- 7 Includes shaft bushing
- 8 Does not have shaft bushing
- 9 3M 370V capacitor
- 10 Has hall effect sensor
- 11 5M 440V Capacitor
- 12 10M 370V Capacitor
- 13 7.5M 370V Capacitor
- 14 7.5M 440V Capacitor
- 15 20M 370V Capacitor
- 16 Rotation is determined by viewing lug end
- 17 7.5M 370V Cap installed
- 18 Rotation is determined by viewing lug end.
- 19 Original motor is SP, D1050 is PSC to provide greater motor efficiency and permit closing shaft end of motor to prevent moisture from entering motor.
- 20 Not a direct replacement, but suitable for referenced models.
- 21 Rotation is determined from viewing lug end
- 22 2M 370V Capacitor
- 23 4 MFD 370V Capacitor
- 24 15M 370V Capacitor
- 25 Equipped with KFan6046 fan blade
- 26 4M 250V Capacitor included
- 27 12.5M 370V Capacitor
- 28 4MFD 370V Capacitor included
- 29 4M 370V capacitor included
- 30 Special low temperature oil
- 31 5M 370V Capacitor
- 32 Not a direct replacement for 5KCP49SG1010S, but is an acceptable substitute.
- 33 Stainless steel shaft
- 34 Mounts on (3) P/N 0061-1518 Coleman Mounts
- 35 Has 8 drilled and tapped holes in shell
- 36 Has 4 drilled and tapped holes in shell
- 37 Includes 8 drilled and tapped holes in shell
- 38 4MFD, 370VAC capacitor rating (not included)
- 39 4MFD, 370VAC capacitor rating (included)
- 40 Original motor is SP, D1050 is PSC to provide greater motor efficiency and permit closing shaft end of motor to prevent moisture from entering motor.
- 41 Includes centrifugal switch
- 42 25M 370V Capacitor
- 43 Packed 6 per carton
- 44 Packed 1 per carton
- 45 Speed nut and vibration damper included.
- 46 Belted Fan & Blower Motor
- 47 56H Mounting
- 48 145T Frame
- 49 Mechanically Reversible
- 50 3M 370V Capacitor Included
- 51 3-1/2" SHAFT HEIGHT
- 52 6M 370V capacitor included
- 53 4M 370 capacitor included
- 54 5M 370V capacitor included
- 55 Has internal fan & 3.5" BC mounting holes for GE 21/29 Frame replacement.
- 56 Drilled and tapped holes in case for Coleman mounting
- 57 Luxaire/Whisperaire
- 58 With plug for Penn Ventilator
- 59 Repl. For Siegler & Williams Wall Heaters
- 60 Penn Ventilator
- 61 Repl. For Butler & Leslie-Locke Roof Ventilator--BX Connector
- 62 Hub only on shaft end
- 63 Repl. For Leslie-Locke Roof Ventilator
- 64 Sterling Radiator Co.
- 65 For use with Greenheck Fan
- 66 Shaft stepped down from 3/8" dia. Shaft
- 67 OEM direct replacement for Jenn Air 80CR
- 68 Used in Jenn Air units. P/N 7108-2101
- 69 Used in Leslie Locke ventilators original P/N 7108-5056
- 70 Used in Acme Eng. Roof Vents
- 71 ILG ventilator 7108-2171. Has internal fan.
- 72 External oil retainer to accommodate resilient rings and cradle base, drilled and tapped holes in case for mounting in Coleman applications. (2 holes each end on case OD).
- 73 Mechanically Reversible
- 74 Popular Ice Machine pump motor
- 75 Shell Turbo 68, low temp. oil (-40°F)
- 76 Impedence Protected
- 77 Has hubs for end rings
- 78 Closed construction
- 79 See Tecumseh OEM section for cross references
- 80 With conduit box
- 81 PSC motor requiring a 10 MFD 370V cap
- 82 Rotation determined by viewing lug end
- 83 Totally enclosed, Sears-Whirlpool 5000-8000 BTU units.
- 84 4M 370V capacitor (similar to GE WJ94X306)
- 85 Air Over
- 86 Drilled & Tapped Holes (No. 8-32NC) in face of case at shaft end for mounting in various Coleman mobile home furnace applications, also has mounting studs.
- 87 Used in Economite, "E-20", LS1/Miller and Mid Continent gas units.
- 88 3 small lugs for Kit 55S
- 89 4 grommets to fit lugs on Kits 34, 49, 50, 55L, 55S
- 90 15 MFD 370V
- 91 7.5MFD 370VAC capacitor
- 92 Shaft up or horizontal applications
- 93 Motor has increased stack for higher ambient temperatures
- 94 7.5 m 440V Capacitor
- 95 Comes with unmounted conduit box.
- 96 Has maximum ventilation for high ambient temperatures
- 97 All angle mount bearings
- 98 All angle mount bearings. Use rainshield when necessary.
- 99 All angle mount bearings.
- 100 10 MFD 370V
- 101 7.5 MFD 370V
- 102 20 MFD 370V
- 103 Ideal for blowers and fans used in furnaces and air-conditioners
- 104 The capacitor and base are included
- 105 Ideal versatility using Kit 200 "X" brackets to accommodate various cradle base lengths
- 106 Includes dust seal
- 107 Includes pull-chain switch
- 108 12.5MFD 370V capacitor included
- 109 No pedestal yoke mount
- 110 Blower system designed to enhance heat output from home fireplaces. Kit includes variable speed control and temperature sensor switch.
- 111 Application: Designed for use in residential outdoor condenser fan and heat pump units (primarily up to 3.5 ton)
- 112 Vibration motor
- 113 PSC version of D1189 (OEM Replacement for Krack Refrigeration).
- 114 Separate connection for each voltage
- 115 Not a direct replacement for 253-1194, but is an acceptable substitute
- 116 Replacement for Airease
- 117 Not a direct replacement for 253-1194, but is an acceptable substitute
- 118 10M 370V capacitor not included
- 119 Has special OEM wiring configuration. Not for general purpose 3 speed applications
- 120 Use Fan Blades with round hub I.D.
- 121 Two Speed Motor
- 122 K110 has maximum flat length
- 123 Double Shafted
- 124 All mounting holes drilled and tapped.
- 125 Continuous Duty
- 126 3/8" shaft diameter with adapter to convert to 1/2" diameter
- 127 Front endshield drilled and tapped with four 10-32 threads on 3.5" bolt circle
- 128 Electrically Reversible
- 129 Repl. For ITT REZNOR
- 130 Do not have extended hubs or rubber rings for base mount
- 131 Motors include shaft bushing
- 132 Open vented on opposite shaft end
- 133 Shaft down or horizontal applications
- 134 Does not have removable conduit boxes
- 135 Special wiring configuration. Cannot be used with SPDT switching.
- 136 Does not come with conduit box.
- 137 Ideal for blowers and fans used in furnaces and air-conditioners.
- 138 Not CSA certified
- 139 All angle mount bearings. Use rainshield when necessary
- 140 Has 10' cordset
- 141 Keyed shaft
- 142 Vertical shaft down application.
- 143 All motors individually boxed.
- 144 Resilient Base
- 145 Interchangeable with GE 21 & 29 Frame motors and other Emerson, Universal & Franklin refrigeration motors
- 146 Interchangeable with GE 21/29 Frame and Universal Motors
- 147 Comes with 2 1/2" O.D. Rubber Mounting Rings
- 148 Weld nuts on 3.5" B.C. for stud mount
- 149 Wiring slightly different from OEM PSC; check nameplate connection diagram. Capacitor and Bracket included. Replaces 2 and 3 speed SP and PSC motor. Motor in Gibson/Belding window units.
- 150 Endshield on D520 is easily removed, allowing rotor and shaft to be rotated, thereby reversing motor rotation.
- 151 Has keyed shaft
- 152 Ideal for unit heaters
- 153 Agricultural applications
- 154 Extended hubs with rubber rings for base mount
- 155 Includes 8 drilled and tapped holes in shell.
- 156 Interchangeable with GE 21 & 29 Frame motors & other Emerson, Universal & Franklin Refrigeration motors
- 157 All angle mount sleeve bearings
- 158 All Rubber rings are used with direct drive blower motors and "Clamp" type supports.
- 159 D180 for International Oil Burner Co.- Furnaces MAC5A, 1045, 1052, 1060, 1145, 1155, 1165, 1175, 1265, 1380, 7040, 7060.
- 160 Henrite are rubber mounting rings with steel band, used with cradle bases and knife edge motor supports.
- 161 Hubless endshields for flush mounting
- 162 Ideal for lug mounting using lug Kit 55L or 55S
- 163 Internal cooling fan
- 164 Rotation is facing side opposite hub
- 165 Skeleton Motor
- 166 3.25" Diameter
- 167 Self-Cooled
- 168 10M 440V Capacitor
- 169 Mounting bracket designed to match the original motor (four 8-32 drilled and tapped holes)
- 170 Mounting hardware included
- 171 Has 22" leads with 1/16" thick insulation
- 172 Three studs opposite shaft end are 8-32 on a standard 2.84" bolt circle, 120° apart
- 173 3.9" diameter
- 174 Includes 1/2" studs for mounting
- 175 Bolt circle = 3.15"
- 176 Endshield on D520 is easily removed, allowing rotor and shaft to be rotated, thereby reversing motor rotation.
- 177 Used in Economite, "E-20", LS1/Miller and Mid Continent gas units.
- 178 External oil retainer to accommodate resilient rings and cradle base, drilled and tapped holes in case for mounting in Coleman applications. (2 holes each end on case OD).
- 179 Self cooled for mechanical duty
- 180 Can be operated on 50Hz with air-over applications
- 181 3 1/2" shaft height
- 182 Has internal fan & 3.5" BC mounting holes for GE 21/29 Frame replacement.
- 183 Drilled and tapped holes in case for Coleman mounting
- 184 D180 for International Oil Burner Co.- Furnaces MAC5A, 1045, 1052, 1060, 1145, 1155, 1165, 1175, 1265, 1380, 7040, 7060.
- 185 Rooftop Ventilator
- 186 Unit Heater
- 187 Includes shaft water slinger
- 188 60° ambient temperature rating
- 189 Closed end shield shaft end
- 190 All angle mount bearings. Use rain shield when necessary.
- 191 Should not be used for replacements where original motor is rated below 1500 RPM
- 192 Ideal versatility using Kit 200 "X" brackets to accommodate various cradle base lengths
- 193 Poultry and Hog House fan motor
- 194 Condenser Fan Motor
- 195 50/60 Hz
- 196 Draft Booster/ Flue Exhaust/ Switch Motors
- 197 For 208V use 7.5M 370V Capacitor and 240V use 6M 370V Capacitor
- 198 Has special OEM wiring configuration. Not for general purpose 3 speed applications
- 199 Original motor is SP, D1050 is PSC to provide greater motor efficiency and permit closing shaft end of motor to prevent moisture from entering motor
- 200 Not a direct replacement for 5KCP49SG1010S, but is an acceptable substitute.
- 201 Not a direct replacement for 253-1194, but is an acceptable substitute
- 202 Original motor is SP, D1050 is PSC to provide greater motor efficiency and permit closing shaft end of motor to prevent moisture from entering motor.
- 203 Leads require modification
- 204 100,000 BTU Furnaces
- 205 Window A/C Using Delco Inside-Outside Motor 485932, KCP39PG9769S



NOTE:

Underwriters Laboratories has developed additional safety requirements for motors used in equipment where abnormal unit operation could likely be undetected by the user, thus increasing the risk of personal injury or property damage.

For example, a motor with a locked shaft could operate undetected for an extended period of time in an attic ventilator fan, thus increasing the risk of fire.

Fasco General Replacement and OEM Direct Replacement products for use in attic ventilators, bathroom ventilators, whole house fans, wall furnaces and other units in the category have been modified to meet these new standards.

Special attention must be given to ensure that **ONLY** the modified products are supplied to customers with units of this type.

Motors that are **NOT SUITABLE** for use in unattended equipment are clearly marked as such with a warning label indicating the increased risk of fire.

The new safety requirements for air moving equipment used in unattended locations within a structure are documented in UL Standard 507, Electric Fans.



ABOUT US

Headquartered in Fort Wayne, Indiana, Genteq has built its reputation on more than 100 years of consistent performance in the industry. Our business has manufacturing sites in the United States, Mexico, India, and China. In addition to the over 200 engineering and technology resources in the United States, Genteq has technology resources located in Hyderabad, India. Our company manufactures and markets a full line of AC electric motors and capacitors for both residential and commercial applications. With a drive for high reliability, quality, innovation, and service, our business strives to meet and exceed our customers' expectations.

OUR PRODUCTS

Genteq High Efficiency and Ultimate Comfort Motors

Genteq technology redefines comfort and efficiency when specified in forced-air heating and cooling systems. These systems feature more even temperatures, better indoor air quality, precise humidity control, quieter operation and lower utility bills.

GE Commercial Motors by REGAL-BELOIT Air Moving "Leader-Line" Motors (HVAC/R)

GE Commercial Motors By REGAL-BELOIT offers a full line of motors to serve the air moving market segment. As the industry leader, many different models are offered for all air moving applications to better serve the needs of each individual customer.

Genteq Capacitors

Genteq has been manufacturing capacitors since the 1950s. Originally located in Fort Edward, New York, production is now located in Juarez, Mexico. With over 300 million capacitors produced and installed, customers can find a selection of oil-filled, dry, and electrolytic capacitors to suit various applications.

HOW TO CONTACT US



GENTEQ

**1946 West Cook Road
Fort Wayne, Indiana 46818**

**Directory: (260) 416-5400
Fax: (260) 416-5460**

www.GenteqMotors.com

GE is a trademark of General Electric Company and is used under license to Regal-Beloit Corporation.



GE Commercial Motors

By Regal-Beloit

GETTING STARTED WITH ELITELINK



1. What is EliteLink?

EliteLink is GE Commercial Motors by Regal-Beloit's e-commerce website for our customers to access information about our products.

2. What information can I access on EliteLink?

ACCOUNTS PAYABLE

The Accounts Payable role can view and search on our catalog search tool, check pricing and availability, view order and invoice histories, place orders, and view payment and credit history.

BUYER

The Buyer role can check price and availability, place orders, view orders and invoice histories, can view and search our catalog search tool.

CUSTOMER SERVICE

The Customer Service role can view and search on our catalog search tool, check pricing and availability, and view orders and invoice histories

CUSTOMER OF GENTEQ CUSTOMER

The Customer of Genteq Customer role can view and search on our catalog search tool and view list prices and availability

HVACR TECHNICAL

HVACR Technical role can access information like drawings, performance data, and other technical documents related to HVACR products.

NOTE: Access to HVACR Technical requires an approved NDA (Non-Disclosure Agreement).

3. How do I get an EliteLink account?

1. Be an authorized distributor for GE Commercial Motors by Regal-Beloit.
2. Go to <http://portal.regalbeloit.com/registration/> and select Register Now!
3. Fill out the required information and select Register Now
4. Once your account is approved, you can then access EliteLink at <http://elitelink.regalbeloit.com/>

4. Who do I contact if I cannot login to my account?

Contact your Regal Beloit Customer Account Representative or contact our EliteLink Administrator at (260) 416-5433 by phone or email elitelink@regalbeloit.com

5. Who do I contact to become an authorized distributor for GE Commercial Motors by Regal-Beloit?

Contact our directory line at (260) 416-5400 to find out if you can qualify to become an authorized distributor of GE Commercial Motors by Regal-Beloit products.

UL/CSA MOTOR LISTINGS

The UL/CSA listings below are blanket file numbers. Refer to the Company for specific volume and section numbers. Where multiple files are shown, refer to the company for specific model.

	UL File Number			CSA File Number
	Motor Comp.	Insulation System	Motor Protectors	Motors
29 & 39 frames (Reynosa)	E46035	E306343	E27885	MC236833
39 frame (Springfield)	E46035	E306343	E27885	MC236833
142R	E306123	E306343	E338178	N/A
ARKTIC 59	E306123	E306343	E338178	N/A
64mm	E46035	E306343	E100625	MC236833

GE is a trademark of General Electric Company and is used under license to Regal-Beloit Corporation.



GE Commercial Motors

By Regal-Beloit

MOTOR TERMINOLOGY

The following check list will help you determine the information necessary to purchase a new or replacement GE Commercial Motors by Regal-Beloit motor. If you are replacing a motor, the old motor nameplate will provide most of the specific information required to select the correct GE Commercial Motors by Regal-Beloit replacement from stock.

Motor Application	Air Moving (furnace fans, air handlers, blowers, air conditioners, exhaust fans, etc.) Commercial Refrigeration (walk-in coolers, beverage coolers, display cases, etc.)
Phase	Single or Three Phase
Type	Capacitor start - Type KC Permanent Split Capacitor - Type KCP Shaded Pole - Type KSM/KSP Capacitor Start Capacitor Run - Type KCR ECM - Type SME Split Phase - Type KH Three Phase - Type K, KE, KS, etc.
Enclosure	Open, Drip-proof, etc.
Mounting	Resilient Base, Solid Base, Footed, Round Frame, etc.
Efficiency	Standard Efficiency, High Efficiency (Energy Saver Plus)
Horsepower	1/16, 1/8, 1/4, 1/3, 1/2, 3/4, 1, etc.
RPM	3600, 1800, 1200, etc., synchronous speed or ... 3450, 1725, 1150, etc. full load speed
Voltage	115, 230, 240, 115/230, 230/460, 575, etc.
Frequency	60 Hertz, 50 Hertz
Frame Size	42, 48, etc.
Service Factor	1.15, 1.0, etc.
Other	Direction of Rotation (CW, CCW) Thermal Protection (see Thermal Protection Information, pg.127) Special Shaft Ambient (40C, 65C, 70C Heatshield) Special Environmental or Operating Conditions



ABBREVIATIONS

Column Abbr.	Typical Data	Explanation
HP	9W, 16W	Rate measured in watts
	1/8, 1, 25	Horsepower rating for fractional and integral sizes"
RPM	825, 1075, 1725, etc.	Shaft rotation speed Full load speed in revolutions-per-minute (NEMA 145T and below)"
	-	Motor Voltage
Volts	115, 230	Single voltage ratings
	115/230	Dual voltage rating
	200-230/460	Usable on 200 volts at 1.0 service factor
	208-230/460"	Spread voltage rating"
Frame	42, 48, etc.	GE 29 = NEMA 42 Frame (approximate 5 inch diameter) GE 39 = NEMA 48 Frame (approximate 5 1/2 inch diameter)
	-	Motor bearing construction
Brgs	Slv	Sleeve bearing each end
	Ball	Ball bearing each end
	-	Service factor rating
SF	1.0, 1.15	Service factor rating
Encl	-	Motor exterior construction/ventilation system
	DP	Dripproof
	Open	Open
	TEAO	Totally enclosed air over
	TENV	Totally enclosed non-ventilated
Prot	-	Protection against excessive heating (thermal overload)
	Auto	Automatic reset thermal protector
	Man	Manual reset thermal protector
	None	No protection provided in the motor
Base	-	Provision for mounting motor on driven equipment
	ECS	Extended clamp screws (no base or resilient rings provided)
	NB	No base provided
	RBE	Resilient cradle base with extended clamp screws
	Rnd	Round frame construction (no feet provided)
	RR	Resilient rings (no base provided)
	RRE	Resilient rings with extended clamp screws (no base provided)
	RRH	Resilient rings and (4) tapped holes
	Spl	Special mounting
	Studs	(4) #8-32 mounting studs
	Tap	(4) tapped holes
	TFL	Torsion flex lugs
	WB	Welded base (rigid base)
	WBE	Welded base with extended clamp screws
Rotation	-	Direction of rotation, motor viewed from opposite shaft end on single shaft motors; from lead end on double shaft motors
	Both	Customer can connect for either CW or CCW rotation
	CW	Clockwise rotation
	CCW	Counter-clockwise rotation
	ECW	Either CW or CCW, connected for CW rotation at factory
	ECCW	Either CW or CCW, connected for CCW rotation at factory
◆	-	Energy Saver Plus design



ABBREVIATIONS (cont'd)

Column Abbr.	Typical Data	Explanation
Dim	-	Motor dimension (please refer to drawing below)
	A	Shaft length on lead end
	B	Shaft length opposite lead end
	C	Overall length of motor including shaft
	YO	Distance between the outer edges of the mounting grooves for the cushion ring

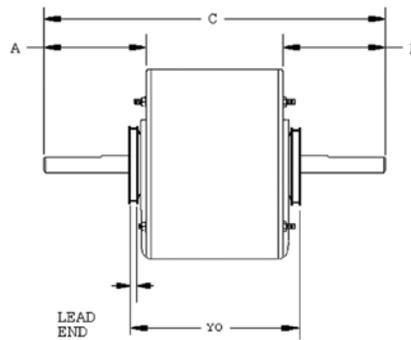

HOW TO READ GENTEQ CATALOG NUMBERS

Numeric Catalog Numbers

2000 series = 29 Frame PSC (NEMA 42 Frame)

3000 series = 39 Frame PSC (NEMA 48 Frame)

5000 series = Morrill refrigeration motors

6000 series = Evergreen

Alphanumeric Catalog Numbers

ex. **A 494**

A = Kits & Accessories

Last three digits are sequentially assigned numbers

ex. **3725 HS**

3000 series = 39 Frame PSC motors

HS = Heatshield Design

ex. **3 S 001**

1 = 84mm/3.3" PSC or SP motors

2 - 29 Frame PSC motors

3 = 39 Frame PSC motors

5 = ECM

A = Air Handler

C = Condenser

D = Direct Drive Fan

F = Furnace Blower

K = Kits & Accessories

M = Fan (misc.)

R = Refrigeration

S = Service - OEM Replacement

Last three digits are sequentially assigned numbers



GE Commercial Motors

By Regal-Beloit

HOW TO DETERMINE IF AN ITEM IS A GENTEQ PRODUCT

Motor Model Numbers Beginning With:		
	Yes	No
5B		X
5C		X
5K...followed by any number		X
5KC3		X
5KC4		X
5KCP29	X	
5KCP3		X
Followed by any number other than 9		
5KCP39	X	
Except any model number beginning with 5KCP39...then a letter that is followed by an "N" (ex. 5KCP39GN..., 5KCP39UNB...)		
5KCP4		X
5KCR		X
5KE		X
5KH		X
5KPM84		X
5KS...followed by any number		X
5KSM11		X
5KSM51		X
5KSM84		X
5KSP11		X
5KSP59		X
5KSP29 (Obsolete)	X	
5KSP39 (Obsolete)	X	
5SME2		X
5SME38		X
5SME39	X	
5SME44 (Obsolete)	X	
5SME5	X	
5SME84 (Obsolete)	X	

Motor Catalog Numbers:		
	Yes	No
2000 series (ex. Cat# 2090)	X	
2S000 series	X	
3000 series	X	
3000HS series	X	
3C000 series	X	
3D000 series	X	
3K000 series	X	
3S000 series	X	
4000 series		X
5000 series	X	
5K000 series	X	
5R000 series	X	
6000 series	X	
6000CTL series	X	
Begins with A...	X	
Except catalog numbers: A109, A110, A111, A112, A113, A114, A115, A225, A228, A229, and A549		
Begins with any other letter than A...		X

Capacitor Model Number Series or Beginning With:		
	Yes	No
23A	X	
23B	X	
23C	X	
23F	X	
23J	X	
23L6000 - 23L6400		X
23L6500 - 23L6899 (Obsolete)	X	
23M	X	
23P	X	
25L	X	
26F1000 - 26F1999		X
26F6600		X
26F6700 - 26F6900		X
26F7000 - 26F7500		X
27L	X	
28F2000		X
28F5500 - 28F5600		X
30F		X
40L	X	
41L	X	
42L	X	
97F5000	X	
97F6000	X	
97F7000	X	
97F7100		X
97F7500		X
97F7600		X
97F8000	X	
97F8100		X
97F8200	X	
97F8500 - 97F8900		X
97F9000	X	



GE Commercial Motors

By Regal-Beloit

HOW TO READ A NAMEPLATE MANUFACTURE DATE

GE Commercial Motors by Regal-Beloit

Nameplate standard effective January 1, 2007

Manufacturing date and plant site identification consists of a four digit code imprinted or stamped on the nameplate. This code also appears on some pallet and/or single box pack labeling.

1. The first character represents the month of manufacture as per the below.

A - January	G - July
B - February	H - August
C - March	I - September
D - April	J - October
E - May	K - November
F - June	L - December

2. The second and third digits are the last two numbers of the year of manufacture. Example 06 for 2006 and 07 for 2007.
3. The fourth/fifth places represent the manufacturing plant.
4. Example: A07 - notes a motor manufactured in January, 2007.
5. Prior date code format, 2006 and earlier. The first letter denoted the month and second the year of manufacture. The third and sometimes fourth characters indicated the manufacturing plant.

	JAN	FEB	MAR	APR	MAY	JUN	JUL	AUG	SEP	OCT	NOV	DEC
1999	NP	OP	PP	RP	SP	TP	UP	VP	WP	XP	YP	XP
2000	NR	OR	PR	RR	SR	TR	UR	VR	WR	XR	YR	ZR
2001	NS	OS	PS	RS	SS	TS	US	VS	WS	XS	YS	ZS
2002	NT	OT	PT	RT	ST	TT	UT	VT	WT	XT	YT	ZT
2003	NV	OV	PV	RV	SV	TV	UV	VV	WV	XV	YV	ZV
2004	NW	OW	PW	RW	SW	TW	UW	VW	WW	XW	YW	ZW
2005	NX	OX	PX	RX	SX	TX	UX	VX	WX	XX	YX	ZX
2006	NY	OY	PY	RY	SY	TY	UY	VY	WY	XY	YY	ZY

SELECTION AND APPLICATION

EXTREMELY IMPORTANT!

Thermal Protection Safety Information

- Motors that start automatically (thermostat controlled or otherwise) and are located out of the sight of the operator, must be protected against the possibility of dangerous overheating due to failure-to-start or overloading of the motor. This protection may consist of a separate overcurrent device (such as a motor starter), a thermally protected motor (with integral overload protection), or an impedance protected motor, complying with Article 430 of the National Electric Code (NEC).
- Motors with automatic reset thermal protection must not be used where automatic or otherwise unexpected starting of the motor could be hazardous. Such applications where automatic restarting could be hazardous include: compressors, conveyors, power tools, farm equipment, and some fans and blowers. Where such a hazard exists, always use a Manual-Reset thermally protected motor.

UL 507 Standard for Thermal Protection

- Any motor used in fan products such as: bathroom exhaust fans, wall-insert fans, ceiling insert fans, attic exhaust fans, whole house fans, and duct fans, etc., which are built into or within the building structure and which are likely to operate unattended or in situations in which the operator may not detect a locked rotor (stalled motor) condition must have either a manual reset thermal protector or a thermal cut-off (one shot) device.
- Range hoods, circulating fans, pedestal fans, and ceiling suspended fans are not included. Agricultural fans are included if they are built into the building structure and are likely to operate unattended or in situations in which the person operating the fan may not detect a locked rotor (stalled motor) condition.

MOTOR APPLICATION CUSTOMER RESPONSIBILITY

This material is designed to assist you in the selection and use of GE Commercial Motors by Regal-Beloit motors, but in the final analysis you, the customer, have the ultimate application responsibility.



GE Commercial Motors

By Regal-Beloit

TERMS AND CONDITIONS OF SALE

ALL QUOTATIONS ARE MADE AND ALL ORDERS ARE ACCEPTED BY REGAL-BELOIT CORPORATION ELECTRICAL GROUP SUBJECT ONLY TO THESE TERMS AND CONDITIONS. THROUGHOUT THIS DOCUMENT, REGAL-BELOIT CORPORATION ELECTRICAL GROUP SHALL BE REFERRED TO AS SELLER.

1. MODIFICATIONS OF SALES TERMS: Any Terms and Conditions contained in any purchase order or other form of communication from Seller's customers which are additional to or different from these Terms and Conditions shall be deemed rejected by Seller unless expressly accepted in writing by Seller. In general, no modification, amendment, waiver or other change of any of these Terms and Conditions and those contained on the reverse side hereof and/or in attachments hereto ("Terms and Conditions"), or of any of Seller's rights or remedies thereunder, shall be binding on Seller unless expressly accepted in writing by Seller's authorized officers. No course of dealing, usage of trade or course of performance shall be relevant to explain or supplement any of these Terms and Conditions. In case of conflict between the Terms and Conditions printed on this page and those contained on the face side or in attachments hereto, the latter shall control. If any document issued by any party hereto is sent by facsimile or another form of electronic document transmission, the parties hereto agree that (a) the copy of any such document printed on the facsimile machine or printer of the recipient thereof is a counterpart original copy thereof and is a "writing", (b) delivery of any such document to the recipient thereof by facsimile or such other form of electronic document transmission is authorized by the recipient thereof and is legally sufficient for all purposes as if delivered by United States mail, (c) the typewritten name of an authorized agent of the party sending such document on any such document is sufficient as a signature thereon on behalf of such party and the intent of such signature is to authenticate the writing, and (d) an electronically stored and reproduced copy of any such document shall be deemed to be legally sufficient evidence of the terms of such document for all purposes.

2. ACCEPTANCE OF ORDERS: Acceptance by Seller of Buyer's purchase order(s) is expressly conditioned upon Buyer's assent to these Terms and Conditions. Buyer will be deemed to have assented to such Terms and Conditions unless Seller receives written notice of any objections within fifteen (15) days after Buyer's receipt of this form and in all events prior to any delivery or other performance by Seller of Buyer's order.

3. QUOTATIONS: Quotations by Seller shall be deemed to be offers by Seller to sell the Goods described therein subject to these Terms and Conditions, and acceptance of such offers is expressly limited to acceptance by Buyer of all of these Terms and Conditions within thirty (30) days from the date of the quotation. Purchase orders submitted by Buyer for the Goods quoted by Seller shall be subject to and will be deemed to constitute acceptance of these Terms and Conditions. All purchase orders will be subject to approval by Seller.

4. PRICES; PRICE CHANGES: All prices are net F.O.B. shipping point and are subject to change without notice. In the event of a change in Seller's prices, the price for Goods unshipped will be the price in effect on the date of shipment.

If Seller's quoted price was based upon delivery to and acceptance by Buyer of a specified quantity of Goods, such price shall be subject to adjustment if Buyer does not accept the quantity at the times specified in Seller's quotation, and Buyer will be invoiced at Seller's standard price without quantity discounts, if any, for the quantity of Goods actually accepted by Buyer.

5. TAXES: In addition to any prices, Buyer shall pay the amount of any present or future manufacturer's tax, retailer's occupation tax, use tax, sales tax, excise tax, duty, custom, inspection or testing fee, or any other tax, fee or charge of any nature whatsoever imposed by any governmental authority, on or measured by the transaction between Seller and Buyer. In the event Seller is required to pay any such tax, fee or charge, Buyer shall reimburse Seller therefor; or, in lieu of such payment, Buyer shall provide Seller at the time the order is submitted with an exemption certificate or other document acceptable to the authority imposing such tax, fee or charge.

6. TERMS OF PAYMENT: All orders are subject to the approval of Seller. Terms of payment are cash in full no later than thirty (30) days from date of shipment, without discount. If, during the period of performance of an order, the financial condition of Buyer is determined by Seller not to justify the terms of payment specified, Seller may demand full or partial payment in advance before proceeding with the work, or satisfactory security or guarantees that invoices will be promptly paid when due, or, at its option

without prejudice to other lawful remedies, may defer delivery or cancel this contract. If delivery is deferred, the Goods may be stored as provided in Section 9 hereof and Seller may submit a new estimate of cost for completion based on prevailing conditions. If Buyer defaults in any payment when due, or in the event any voluntary or involuntary bankruptcy or insolvency proceedings involving Buyer are initiated by or against Buyer, then the whole contract price shall immediately become due and payable upon demand, or Seller, at its option without prejudice to its other lawful remedies, may defer delivery or cancel this contract.

Prorata payments shall become due as shipments are made. If shipments are delayed by the Buyer for any cause, payments shall become due from the date on which Seller is prepared to make shipment and storage shall be the Buyer's risk and expense as provided in Section 9 hereof. If manufacture is delayed by the Buyer for any cause, a partial payment based upon the proportion of the order completed shall become due from the date on which Seller is notified of the delay.

7. DELIVERY; RISK OF LOSS: All sales are F.O.B. Seller's plant or other point of shipment designated by Seller. Shipping dates are estimates only which are not guaranteed and are based upon prompt receipt from Buyer of all necessary shipping and other information. Seller reserves the right to make delivery in installments, all installments to be separately invoiced and paid for by Buyer when due per invoice, without regard to subsequent deliveries.

Delivery of Goods to a commercial carrier at Seller's plant or other loading point shall constitute delivery to Buyer, and any risk of loss and further cost and responsibility thereafter for claims, delivery, loss or damage, including, if applicable, placement and storage, shall be borne by Buyer. When Goods are delivered by Seller's truck, unloading at Buyer's dock shall constitute delivery to Buyer. Claims for shortages or other errors in delivery must be made in writing to Seller within ten (10) days after receipt of shipment and failure to give such notice shall constitute unqualified acceptance and a waiver of all such claims by Buyer. Claims for loss or damage to Goods in transit by common carrier must be made to the carrier and not to Seller.

Freight and handling charges by Seller may not reflect actual freight charges prepaid to the carrier by Seller due to incentive discounts earned by Seller based upon Seller's aggregate volume of freight tendered to a carrier or when a carrier must be used which charges a rate which is different than the rate upon which Seller's freight and handling charges were based. When shipments are delivered in Seller's private trucks Buyer will be charged an amount approximating the prevailing common carrier rate.

8. EXCUSABLE DELAYS; FORCE MAJEURE: Seller shall not be liable for any ordinary, incidental, or consequential loss or damage as a result of Seller's delay in or failure of delivery or installation due to (i) any cause beyond Seller's reasonable control, (ii) an act of God, act of the Buyer, embargo or other government act, authority, regulation or request, fire, theft, accident, strike, slowdown or other labor disturbance, war, riot, delay in transportation, or (iii) inability to obtain necessary labor, materials, components, or facilities.

Should any of the aforementioned events of force majeure occur, Seller, at its option, may cancel Buyer's order with respect to any undelivered Goods or extend the delivery date for a period equal to the time lost because of delay. Notice of such election shall be given promptly to Buyer. In the event Seller elects to so cancel the order, Seller shall be released of and from all liability for failure to deliver the Goods, including, but not limited to, any and all claims on behalf of Buyer for lost profits, or any other claim of any nature which Buyer might have.

If shipping or progress of the work is delayed or interrupted by Buyer, directly or indirectly, Buyer shall pay Seller for all additional charges resulting therefrom.

9. STORAGE: If the Goods are not shipped within thirty (30) days after notification has been made to Buyer that it is ready for shipping, for any reason beyond Seller's control, including Buyer's failure to give shipping instructions, Seller may store the Goods at Buyer's risk and expense in a warehouse or on Seller's premises, and Buyer shall pay all handling, transportation and storage costs at the prevailing commercial rates promptly following Seller's submission of invoices for such costs.

10. WARRANTIES TO DISTRIBUTORS AND INDUSTRIAL OR COMMERCIAL CUSTOMERS: This warranty is extended only to Seller's distributors and industrial or commercial customers and does not apply to consumer purchasers.

(CONTINUED ON NEXT PAGE.)



GE Commercial Motors

By Regal-Beloit

TERMS AND CONDITIONS OF SALE (cont'd)

Warranty Period - Motors

The Seller warrants motors manufactured by or for it to be free from defects in materials and workmanship and to conform to its written specifications for a period of twelve (12) months from date of first use or eighteen (18) months from date of manufacture, whichever period shall expire first.

Warranty Period - Generators

(a) The Seller warrants stand-by generators manufactured by or for it to be free from defects in materials and workmanship and to conform to its written specifications for a period of twenty-four (24) months from date of startup, thirty (30) months from date of shipment, or one-thousand (1,000) hours in use, whichever period shall expire first; (b) Seller warrants continuous duty generators manufactured by or for it to be free from defects in materials and workmanship and to conform to its written specifications for a period of twelve (12) months from date of startup or eighteen (18) months from date of shipment, whichever period shall expire first.

Certain Electrical Group Goods are warranted for different periods of time under specific conditions. Buyer must consult the current product catalog or internet site to confirm this warranty period.

Warranty Remedies - If, prior to expiration of the foregoing applicable warranty period, any of such Goods shall be proved to Seller's satisfaction to be defective or nonconforming, Seller will repair or replace such defective Goods or components thereof, F.O.B. Seller's plant or other destination designated by Seller, or will refund or provide Buyer with a credit in the amount of the purchase price paid therefor by Buyer, at Seller's sole option. Buyer's exclusive remedy and Seller's sole obligation under this warranty shall be limited to such repair or replacement, F.O.B. Seller's plant or other destination designated by Seller, or refund or credit by Seller, and shall be conditioned upon Seller's receiving written notice of any defect within a reasonable period of time (but in no event more than sixty (60) days) after it was discovered or by reasonable care should have been discovered. In no event shall Seller's liability for such defective or nonconforming Goods exceed the purchase price paid by Buyer therefor.

Exclusions - This warranty does not: (i) cover shipping expenses to and from Seller's factory or other destination designated by Seller for repair or replacement of defective Goods or any tax, duty, custom, inspection or testing fee, or any other charge of any nature related thereto, nor does it cover the costs of disassembling or removing defective Goods or reassembling, reinstalling, or testing repaired or replaced Goods or finishing the reinstallation thereof; (ii) apply and shall be void with respect to Goods operated in excess of rated capacity or otherwise not in accordance with installation, maintenance, or operating instructions or requirements, to Goods repaired or altered by others than Seller or Seller's authorized service agencies, or to Goods which were subjected to abuse, negligence, misuse, misapplication, accident, damages by circumstances beyond Seller's control, to improper installation (if by others than Seller), operation, maintenance or storage, or to other than normal use or service; and (iii) apply to equipment or components not manufactured by or for Seller. With respect to Goods or components not manufactured by Seller, Seller's warranty obligations shall in all respects conform and be limited to the warranty actually extended to Seller by its suppliers, but in no event shall Seller's obligations be greater than those provided under Seller's warranty set forth in this Section 10.

THE FOREGOING WARRANTIES ARE IN LIEU OF ALL OTHER EXPRESS AND IMPLIED WARRANTIES (EXCEPT TITLE), INCLUDING, WITHOUT LIMITATION, THE IMPLIED WARRANTIES OF MERCHANTABILITY AND FITNESS FOR A PARTICULAR PURPOSE. NO EMPLOYEE, REPRESENTATIVE, OR AGENT OF SELLER OTHER THAN AN OFFICER OF SELLER IS AUTHORIZED TO ALTER OR MODIFY ANY PROVISION OF THIS SECTION 10 OR TO MAKE ANY GUARANTEE, WARRANTY, OR REPRESENTATION, EXPRESS OR IMPLIED, ORALLY OR IN WRITING, WHICH IS CONTRARY TO THE FOREGOING. Any description of the Goods, whether in writing or made orally by Seller or Seller's agents, specifications, samples, models, bulletins, drawings, diagrams, engineering sheets or similar materials used in connection with Buyer's order are for the sole purpose of identifying the Goods and shall not be construed as an express warranty. Any suggestions by Seller or Seller's agents regarding use, application or suitability of the Goods shall not be construed as an express warranty unless confirmed to be such in writing by Seller's authorized officer.

11. LIMITATIONS OF LIABILITY; CONSEQUENTIAL DAMAGES: Nuclear Use Disclaimer - Goods sold by Seller are not intended for use in connection with any nuclear facility or activity. If so used, Seller disclaims all liability for any nuclear damage, injury or contamination, and Buyer shall indemnify and hold Seller, its officers,

agents, employees, successors, assigns and customers harmless from and against any and all losses, damages or expenses of whatever form or nature (including attorneys' fees and other costs of defending any action) which they or any of them may sustain or incur, whether as a result of breach of contract, warranty, tort (including negligence) or otherwise, by reason of such use.

Consequential Damage Disclaimer - Seller's liability with respect to Goods proved to its satisfaction to be defective within the warranty period shall be limited to repair, replacement or refund as provided in Section 10 hereof, and in no event shall Seller's liability exceed the purchase price of the Goods involved. Seller shall not be subject to any obligations or liabilities, whether arising out of breach of contract, warranty, tort (including negligence) or other theories of law, with respect to Goods sold or services rendered by Seller, or any undertakings, acts or omissions relating thereto. Without limiting the generality of the foregoing, Seller specifically disclaims any liability for property or personal injury damages, penalties, special or punitive damages, damages for lost profits or revenues, loss of use of Goods or any associated Goods, cost of capital, cost of substitute products, facilities or services, downtime, shutdown, or slowdown costs, or for any other types of economic loss, and for claims of Buyer's customers for any such damages.

SELLER SHALL NOT BE LIABLE FOR AND DISCLAIMS ALL CONSEQUENTIAL, INCIDENTAL AND CONTINGENT DAMAGES WHATSOEVER. EVEN IF THE REPAIR OR REPLACEMENT REMEDY SHALL BE DEEMED TO HAVE FAILED OF ITS ESSENTIAL PURPOSE UNDER SECTION 2-719 OF THE UNIFORM COMMERCIAL CODE, SELLER SHALL HAVE NO LIABILITY TO BUYER FOR CONSEQUENTIAL DAMAGES, SUCH AS LOST PROFITS, LOST REVENUE, DAMAGE TO OTHER GOODS OR LIABILITY OR INJURY TO A THIRD PARTY.

12. INDEMNIFICATION BY BUYER: Buyer shall indemnify, hold harmless, and defend Seller and Seller's employees and agents from and against any and all damages, liability, claims, losses, and expenses (including reasonable attorneys' fees, court costs, and out-of-pocket expenses) arising out of or resulting in any way from claims by customers of Buyer or third parties against Seller alleging a breach of contract or warranty by Seller to the extent that such damages, liability, claims, losses, and expenses which may be payable by Seller to Buyer pursuant to and as limited by Seller's warranty and damage obligations as contained in Sections 10 and 11 hereof so as to effectively limit Seller's obligations to customers of Buyer or third parties to those set forth in Sections 10 and 11 hereof.

13. PATENT INDEMNIFICATION: Seller will, at its own expense, defend or settle any suits that may be instituted against Buyer for alleged infringement by the Goods of any United States patent, provided that: (a) such alleged infringements consist of the use of the Goods for any of the purposes for which such Goods were sold; (b) Buyer shall have made all payments for such Goods then due hereunder; (c) Buyer shall give Seller immediate notice in writing of any such suit and transmit to Seller immediately upon receipt of all processes and papers served upon Buyer; and (d) Buyer shall permit Seller through its counsel, either in the name of Buyer or in the name of Seller, to defend such suit(s) and give all needed information, assistance and authority to enable Seller to do so.

In case of a final award of damages in any such suit, Seller will pay such award but will not be responsible for any compromise or settlement made without its written consent. In case the Goods itself is in such suit held to infringe any valid patent issued in the United States and its use enjoined, or in the event of a settlement or compromise approved by Seller which shall preclude future use of the Goods sold to Buyer hereunder, Seller shall, at its own expense and at its sole option, either: (a) procure rights to continue using such Goods; (b) modify the Goods to render it noninfringing; (c) replace the Goods with non-infringing Goods; or (d) refund the purchase price paid by Buyer for the Goods after return of the Goods to Seller. Notwithstanding the foregoing, Seller shall not be held responsible for infringements of combination or process patents covering the use of Goods in combination with other Goods or materials not furnished by Seller.

The foregoing states the entire liability of Seller for patent infringement, and **IN NO EVENT SHALL SELLER BE LIABLE FOR CONSEQUENTIAL OR INCIDENTAL DAMAGES ATTRIBUTABLE TO AN INFRINGEMENT** nor for infringement based on the use of the Goods for a purpose other than that for which sold by Seller. As to any Goods furnished by Seller to Buyer manufactured in accordance with designs proposed or furnished by Buyer or any claim of contributory infringement resulting from the use or resale by Buyer of Goods sold hereunder, Buyer shall indemnify Seller for any award made against Seller or

(CONTINUED ON NEXT PAGE.)



GE Commercial Motors

By Regal-Beloit

Data subject to change without notice

129

TERMS AND CONDITIONS OF SALE (cont'd)

settlement by Seller for any patent, trademark or copyright infringements including attorneys' fees and defense costs.

14. SECURITY AGREEMENT AND FINANCING STATEMENTS: To secure payment of the purchase price and of all monies which may be due hereunder, and performance of all of Buyer's obligations hereunder, Buyer hereby grants to Seller a security interest in all Goods sold by Seller, and agrees to execute such other Security Agreements and Financing Statements as Seller may reasonably request.

15. INSURANCE: Until payment in full of the purchase price, Buyer shall maintain insurance covering all Goods sold by Seller to Buyer in such amounts and against such risks as is customary by companies engaged in the same or similar business and similarly located, and shall, upon Seller's request, furnish evidence of such insurance satisfactory to Seller.

16. DRAWINGS; OTHER DESIGN DATA: All specifications, drawings, designs, data, information, ideas, methods, tools, gages, dies, fixtures, patterns and/or inventions made, conceived, developed or acquired by Seller in connection with procuring and/or executing Buyer's order will vest in and inure to Seller's sole benefit notwithstanding any changes therefor which may have been or may be imposed by Seller.

Buyer shall not give, loan, exhibit, sell or transfer to any person not then employed by Buyer and authorized to receive such information, or to any organization or entity, any drawing, photograph or specification furnished by Seller or reproduction thereof which may enable such person, organization or entity to furnish similar Goods or parts therefor.

17. RETURN OF GOODS: No Goods or part shall be returned to Seller without written authorization and shipping instructions first having been obtained from Seller.

18. ASSIGNMENT AND SUBCONTRACTING: None of the Buyer's rights under any order shall be assigned by the Buyer to any other person, whether by operation of law or otherwise, without Seller's prior written approval. Seller may, without the necessity of obtaining Buyer's prior written consent, subcontract the production of all or any portion of the Goods.

19. CANCELLATION: No order submitted to Seller may be cancelled by Buyer without the prior written consent of Seller, which consent will at all times be conditioned on Buyer's agreement to pay Seller's cancellation charge. For finished Goods which in Seller's judgement is readily resalable to others, the cancellation charge shall be 15% of the invoice price of the Goods. For all other cancellations, the cancellation charge shall amount to all cost and expenses incurred by Seller and arising out of or in connection with Buyer's order, net of recoverability, but in no event less than 10% of the invoice price of the Goods or more than the invoice price.

20. GENERAL:

Governing law - These Terms and Conditions, and the contract of sale between Seller and Buyer, shall be governed by and construed in accordance with the laws of the State of Wisconsin. Seller and Buyer hereby agree that any legal action deemed necessary by either party hereto shall be brought in the Circuit Court in and for Seller County, Wisconsin and hereby consent to the personal jurisdiction of such court in any such action over the parties hereto. The rights and obligations of Seller and Buyer shall not be governed by the provisions of the United Nations Convention on Contracts for the Internal Sale of Goods.

Attorneys' Fees - Buyer agrees to pay all of Seller's costs and expenses of collection and related litigation, including but not limited to attorneys' fees and costs.

Severability - The invalidity, in whole or in part, of any of the provisions of these Terms and Conditions, shall not affect the enforceability of any of the other provisions thereof.

Applicability - The Terms and Conditions as stated herein are applicable as of the date of this printing and until such time as changed by Seller.

MPN411 5/89 REVISED 10/06



GE Commercial Motors

By Regal-Beloit

TABLE OF CONTENTS

Morrill Commercial Refrigeration Motors	133-134
ARKTIC™ 142	
ARKTIC 142™ - Belly Band Mounting	133
ARKTIC™ 59	
ARKTIC 59 - Mounting Studs - Both Sides	133
ARKTIC 59 - Mounting Studs - Front Only	133
ARKTIC 59 - VSD Mounting Bracket	133
SSC ² ™	
SSC ² ™ Refrigeration Motors	134
GE Commercial Motors by Regal-Beloit HVAC Motors	135-147
Direct Drive Fan & Central Air Conditioning - Single Phase	
Permanent Split Capacitor - 5 1/2" Diameter - Three Speed	135
Permanent Split Capacitor - 5 1/2" Diameter - Four Speed	135
Permanent Split Capacitor - 5 1/2" Diameter - Torsion Flex Mounting	135
Permanent Split Capacitor - 5 1/2" Diameter - Two and Three Speed	136
Direct Drive Fan & Blower - Single Phase	
Permanent Split Capacitor - 5 1/2" Diameter - Open - Double Shaft	137
Permanent Split Capacitor - 5" Diameter - Open - Double Shaft	138
Permanent Split Capacitor - 5 1/2" Diameter - Open - Single Shaft - 460 Volt	138
Permanent Split Capacitor - 5" Diameter - Open - Single Shaft	139
Permanent Split Capacitor - 5 1/2" Diameter - Open - Single Shaft	139
Life-Line™ Standard Multi-Horsepower Motors	
Direct Drive Fan & Blower - Energy Saver Plus	140
Condenser Fan & Heat Pump	141-142
Life-Line™ Heatshield™ Multi-Horsepower Motors	
Condenser Heat Pump - Multi-Horsepower 4-in-1	143
Heatshield™ Motors	
Outdoor Condenser Fan	144
Outdoor Condenser Fan - Commercial 460 Volt	144
Condenser Fan & Heat Pump - Single Phase	
Permanent Split Capacitor - Shaft Up or Horizontal Application	145
Permanent Split Capacitor - Shaft Up or Down Application	146
Unit Heater Fans - Single Phase	
Permanent Split Capacitor - 5 1/2" Diameter With Accessories Kit	147
21/29 Frame Replacement - Single Phase	
Permanent Split Capacitor - Totally Enclosed - Single Shaft	147
Condenser Fan & Heat Pump - Cap-Can Construction	
Permanent Split Capacitor - 5" Diameter - Totally Enclosed Air Over	147



TABLE OF CONTENTS (CONT)

OEM Replacement Motors	148-161
Capacitors	162-165
Genteq™ PROLINE™ Capacitors	
PROLINE™ - Oval - 240 Volt AC162
PROLINE™ - Oval - 370 Volt AC162
PROLINE™ - Oval - 440 Volt AC162
PROLINE™ - Round - 440 Volt AC163
Genteq™ Capacitors	
Oval - 280 Volt AC164
Oval - 330 Volt AC164
Oval - 370 Volt AC164
Oval - 440 Volt AC164
Round - 240 Volt AC165
Round - 370 Volt AC165
Round - 440 Volt AC165
Kits & Accessories	166-168
Genteq™ Accessories	167
ECM Service Tools	
Genteq™ TECMate Service Tool167
Genteq™ ECM Service Guide167
Genteq™ Evergreen ®	171-172
Evergreen AH ® Motors	
Evergreen AH ® Motors - 208-230 Volt171
Evergreen IM ® Motors	
Evergreen IM ® Motors - 115/230 Volt172
Evergreen ® Accessories	
Evergreen ® Motor Belly Band Mounting Kits172
Evergreen IM ® Replacement Modules172
Cross Reference	
Catalog Number to Model Number	173-176
Model Number to Catalog Number	177-180
Warnings & Cautions	181
Notes	182



MORRILL COMMERCIAL REFRIGERATION MOTORS
ARKTIC™ 142 MOTORS

ARKTIC™ 142



Features

- RoHS compliant NEMA 48 Frame electronically commutated motor
- 1/2" shaft diameter and shaft water slinger
- 26" cord set attached to motor
- Horizontal - vertical down orientation desired
- Totally enclosed, Non-vented (air-over ECM required)

Applications

Designed primarily for use in the evaporator of commercial refrigeration walk-in coolers and freezers as well as outdoor condensers, but can be used in many applications demanding high efficiency and dependability with output ratings between 1/5 – 1 HP including parallel rack fan motors

ARKTIC™ 142 - Belly Band Mounting

HP	Speeds	RPM	Volts	Rotation	FLA @ NP	Multiplier	Catalog No.	C Dim	B Dim	Notes
1/5	1	1075	115	CW	4.6	RB1E23	5R002	9.53	4.00	12,14
	1	1075	230	CW	1.9-2.8	RB1E23	5R004	9.59	4.00	12,14
1/3	1	1075	115	CCW	5.8	RB1E23	5R005	10.09	4.00	12,14
	1	1075	230	CCW	2.6-3.5	RB1E23	5R007	10.09	4.00	12,14

NOTES: 12 = Designed for 50 or 60 Hz operation; 14 = Ball bearing

ARKTIC™ 59 MOTORS

ARKTIC™ 59



Features

- RoHS compliant 3.3" diameter electronically commutated motor
- 5/16" shaft diameter and shaft water slinger
- 24" cord set attached to motor
- Horizontal - vertical down orientation desired
- Totally enclosed, Non-vented (air-over ECM required)

Applications

Designed primarily for use in the evaporator of commercial refrigeration walk-in coolers and freezers, but can be used in many air-moving applications demanding high efficiency and dependability with output ratings up to 74.6 watts

ARKTIC™ 59 - Mounting Studs - Both Sides

HP	Speeds	RPM	Volts	Rotation	FLA @ NP	Multiplier	Catalog No.	C Dim	B Dim	Notes
1/20	1	1550	115	CW	1.75	RB1E84	5105	6.45	2.61	12, 14
	1	1550	115	CCW	1.75	RB1E84	5106	6.45	2.61	12, 14
	1	1550	208-230	CW	0.94	RB1E84	5205	6.45	2.61	12, 14
	1	1550	208-230	CCW	0.94	RB1E84	5206	6.45	2.61	12, 14
1/15	1	1550	115	CW	1.30	RB1E84	5100	6.74	2.61	12, 14
	1	1550	115	CCW	1.30	RB1E84	5101	6.74	2.61	12, 14
	1	1550	208-230	CW	0.80	RB1E84	5200	6.74	2.61	12, 14
	1	1550	208-230	CCW	0.80	RB1E84	5201	6.74	2.61	12, 14
2	1550/550	115	CCW	1.30	RB1E84	5110	5110	6.74	2.61	12, 14
	2	1550/550	115	CW	1.30	RB1E84	5111	6.74	2.61	12, 14
	2	1550/550	208-230	CCW	0.80	RB1E84	5210	6.74	2.61	12, 14
	2	1550/550	208-230	CW	0.80	RB1E84	5211	6.74	2.61	12, 14

ARKTIC 59 - Mounting Studs - Front Only

1/15	1	1550	115	CCW	1.30	RB1E84	5102	6.29	2.61	12, 14
	1	1550	115	CW	1.30	RB1E84	5103	6.29	2.61	12, 14
	1	1550	208-230	CCW	0.80	RB1E84	5202	6.29	2.61	12, 14
	1	1550	208-230	CW	0.80	RB1E84	5203	6.29	2.61	12, 14
	2	1550/550	115	CCW	1.30	RB1E84	5120	6.29	2.61	12, 14
	2	1550/550	115	CW	1.30	RB1E84	5121	6.29	2.61	12, 14
	2	1550/550	208-230	CCW	0.80	RB1E84	5220	6.29	2.61	12, 14
	2	1550/550	208-230	CW	0.80	RB1E84	5221	6.29	2.61	12, 14

ARKTIC 59 - VSD Mounting Bracket

1/15	1	1550	115	CCW	1.30	RB1E84	5104	5.64	1.01	12, 14
	1	1550	208-230	CCW	0.80	RB1E84	5204	5.64	1.01	12, 14





Features

- Drop in replacement for the 3.3" Shaded Pole & PSC motors
- Ultra-high efficiency
- 2 speed operation for increased energy reduction
- Constant speed technology
- Ultra-quiet design
- Moisture-resistant construction
- Maintenance free
- RoHS compliant

Applications

Designed for condenser and evaporator fan motors used in display cases, ice machines, beverage merchandisers, vending machines, and other similar applications.

NOTE: Motors are pallet packed! Order in multiples of 6 pieces, minimum order quantity is 6 pieces!

SSC²™ Refrigeration Motors

Speeds	Watts	RPM	Volts	Rotation	FLA @ NP	Mutiplier	Catalog No.	Notes
Single	12	1550	115	CW	0.3	RB1E23	5R016	
	12	1550	115	CW	0.3	RB1E23	5R024	
	12	1550	115	CW	0.3	RB1E23	5R025	
	16	1550	115	CW	0.3	RB1E23	5R020	
	25	1550	115	CW	0.4	RB1E23	5R021	
	38	1550	115	CCW	0.9	RB1E23	5R017	
	38	1550	115	CCW	0.9	RB1E23	5R022	
	12	1550	208-230	CW	0.15	RB1E23	5R019	12
	38	1550	208-230	CCW	0.45	RB1E23	5R018	12
	38	1550	208-230	CCW	0.45	RB1E23	5R023	12

NOTES: 12 = Designed for 50 or 60 Hz operation.

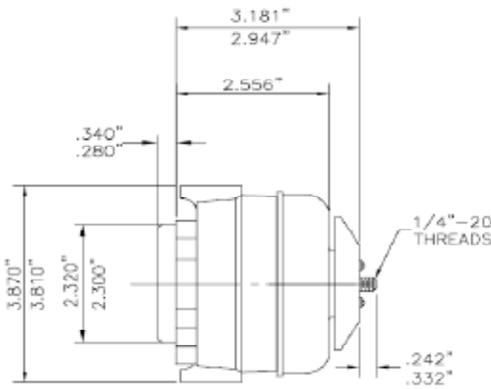

Note: Dimensions for Cat Nos. 5R016, 5R019, 5R020, 5R021, 5R024, and 5R025

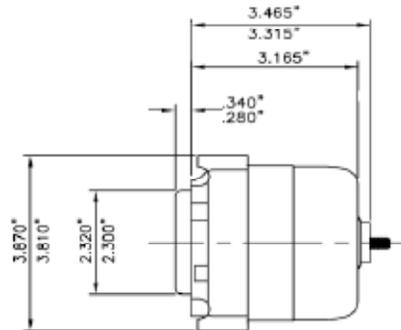

Note: Dimensions for Cat Nos. 5R017, 5R018, 5R022, and 5R023



GE COMMERCIAL MOTORS BY REGAL-BELOIT HVAC MOTORS
DIRECT DRIVE FURNACE & CENTRAL AIR CONDITIONING
Energy Saver Plus



Cat. #3984

Features

- Optimized high efficiency design
- Upper NEMA Hp band
- All-angle mounting position
- Reversible rotation with reversing plug
- 6.5" shaft
- 30" leads
- Cushion ring mounting
- 2 ¼ - 2 ½ resilient ring adapter included
- Extended thru bolts on both ends
- Class B Insulation
- Automatic thermal overload protection
- 65% minimum efficiency at 1075 RPM (unless otherwise noted)

Applications

Designed for continuous air over applications, such furnace blowers or central air handling units with single shaft requirements.

Permanent Split Capacitor - 5 1/2" Diameter - Three Speed

HP	RPM	Speed	Volts	Base	Rotation	FLA @ NP	Catalog No.	C Dim.	Notes
1/4	1075	3	115	2RR	CCW/CW	3.60	3983	11.89	14, 15
	1075	3	208-230	2RR	CCW/CW	1.70	3984	11.89	14, 15
1/3	1075	3	115	2RR	CCW/CW	4.70	3985	12.39	14, 15
	1075	3	208-230	2RR	CCW/CW	2.50	3986	12.39	14, 15
	1075	3	460	2RR	CCW/CW	1.08	3D006	12.39	12, 14, 15
1/2	1075	3	115	2RR	CCW/CW	7.50	3987	13.14	14, 15
	1075	3	208-230	2RR	CCW/CW	3.80	3988	12.89	14, 15
	1075	3	460	2RR	CCW/CW	1.63	3D007	12.89	12, 14, 15
3/4	1075	3	115	2RR	CCW/CW	10.00	3989	13.14	14, 15
	1075	3	208-230	2RR	CCW/CW	4.50	3990	13.14	14, 15
	1075	3	460	2RR	CCW/CW	2.13	3D008	13.39	14, 15

Permanent Split Capacitor - 5-1/2" Diameter - Four Speed

1/6	1075	4	277/230	2RR	CCW/CW	0.78	3D001	11.39	12, 14, 15, 16
1/4	1075	4	277/230	2RR	CCW/CW	1.10	3D002	11.89	12, 14, 15
1/3	1075	4	277/230	2RR	CCW/CW	0.87	3D003	12.39	12, 14, 15
1/2	1075	4	277/230	2RR	CCW/CW	3.10	3D004	12.89	12, 14, 15
3/4	1075	4	277/230	2RR	CCW/CW	3.60	3D005	13.39	12, 14, 15

NOTES: 12 = Designed for 50 or 60 Hz operation; 14 = Ball bearing; 15 = Rheem mounting holes in shell; 16 = 60% minimum efficiency at 1075 RPM

DIRECT DRIVE FURNACE & CENTRAL AIR CONDITIONING
Single Phase



Cat. #3787

Features

- Standard efficiency designs
- Reversible rotation (permanent split capacitor only)
- Mounting holes in shell for capacitor bracket
- KCP models designed for 370 Volt capacitor (not furnished)
- 4" shaft extension with resilient ring mounting
- 5" shaft extension with torsion flex mounting
- Torsion flex lugs are furnished with rubber mounting grommets
- Automatic thermal overload protection

Applications

Designed for continuous air over applications, such as furnace blowers or central air handling units with single shafts requirements

Permanent Split Capacitor - 5 1/2" Diameter - Torsion Flex Mounting

HP	RPM	Speed	Volts	Base	Rotation	FLA @ NP	Catalog No.	C Dim.	Notes
1/6	1075	3	115	TFL	CCW/CW	2.5	3782	9.10	4
1/4	1075	3	115	TFL	CCW/CW	3.7	3783	8.90	4
	1075	3	208-230	TFL	CCW/CW	1.7	3784	9.30	4
1/3	1075	3	115	TFL	CCW/CW	4.9	3785	10.10	4
	1075	3	208-230	TFL	CCW/CW	2.5	3786	9.80	4
1/2	1075	3	115	TFL	CCW/CW	7.3	3787	10.60	4
	1075	3	208-230	TFL	CCW/CW	3.5	3788	10.30	4
3/4	1075	3	115	TFL	CCW/CW	10.3	3789	10.60	4
	1075	3	208-230	TFL	CCW/CW	4.8	3790	10.60	4

NOTES: 4 = Sleeve bearing



GE Commercial Motors

By Regal-Beloit

GE COMMERCIAL MOTORS BY REGAL-BELOIT HVAC MOTORS
DIRECT DRIVE FURNACE & CENTRAL AIR CONDITIONING
Single Phase



Features

- Energy Saver Plus design (◆)
- Reversible rotation
- Mounting holes in shell for capacitor bracket
- Designed for 370 Volt capacitor (not furnished)
- 4" shaft extension
- Extended clamp screws on shaft end with a ring kit provided
- Ring kit allows both 2 1/4" and 2 1/2" resilient ring mounting
- Automatic thermal overload protection

Cat. #3983

Applications

Designed for continuous air over applications, such as furnace blowers or central air handling units with single shaft requirements.

Permanent Split Capacitor - 5 1/2" Diameter - Two & Three Speed

HP	RPM	Speed	Volts	Base	Rotation	FLA @ NP	Catalog No.	C Dim.	Notes
1/4	1625	3	115	2RR	CCW/CW	2.7	3992	9.10	4
	1625	3	208-230	2RR	CCW/CW	1.2	3993	9.10	4
	1075	2	115	2RR	CCW/CW	4.2	3383	9.10	4
	1075	3	115	2RR	CCW/CW	3.7	3983 ◆	9.60	14, 15
	1075	3	115	2RR	CCW/CW	4.2	3583	9.10	4
	1075	2	208-230	2RR	CCW/CW	2.0	3384	9.10	4
	1075	3	208-230	2RR	CCW/CW	2.0	3584	9.10	4
	1075	3	208-230	2RR	CCW/CW	1.7	3984 ◆	9.60	14, 15
1/3	1625	3	115	2RR	CCW/CW	3.9	3994	9.60	4
	1625	3	208-230	2RR	CCW/CW	1.9	3995	9.60	4
	1075	2	115	2RR	CCW/CW	6.2	3385	9.40	4
	1075	3	115	2RR	CCW/CW	6.1	3585	9.40	4
	1075	3	115	2RR	CCW/CW	4.9	3985 ◆	9.60	14, 15
	1075	2	208-230	2RR	CCW/CW	2.9	3386	9.40	4
	1075	3	208-230	2RR	CCW/CW	2.7	3586	9.40	4
	1075	3	208-230	2RR	CCW/CW	2.5	3986 ◆	9.60	14, 15
1/2	1625	3	115	2RR	CCW/CW	6.0	3996	9.90	4
	1625	3	208-230	2RR	CCW/CW	2.8	3997	9.90	4
	1075	2	115	2RR	CCW/CW	9.0	3387	10.40	4
	1075	3	115	2RR	CCW/CW	9.0	3587	10.40	4
	1075	3	115	2RR	CCW/CW	7.3	3987 ◆	10.10	14, 15
	1075	2	208-230	2RR	CCW/CW	4.3	3388	10.10	4
	1075	3	208-230	2RR	CCW/CW	4.3	3588	10.10	4
	1075	3	208-230	2RR	CCW/CW	3.5	3988 ◆	10.10	14, 15
3/4	1625	3	115	2RR	CCW/CW	8.5	3998	10.40	4
	1625	3	208-230	2RR	CCW/CW	4.0	3999	10.40	4
	1075	2	115	2RR	CCW/CW	10.3	3389	10.40	4
	1075	3	115	2RR	CCW/CW	11.2	3589	10.40	4
	1075	3	115	2RR	CCW/CW	10.3	3989 ◆	10.10	14
	1075	2	208-230	2RR	CCW/CW	5.2	3390	10.40	4
	1075	3	208-230	2RR	CCW/CW	5.0	3590	10.40	4
	1075	3	208-230	2RR	CCW/CW	4.8	3990 ◆	10.10	14, 15
1	1075	3	115	2RR	CCW/CW	11.8	3595	10.65	14
	1075	3	208-230	2RR	CCW/CW	5.6	3596	10.65	14

NOTES: 4 = Sleeve bearing; 14 = Ball bearing.



GE Commercial Motors

By Regal-Beloit

GE COMMERCIAL MOTORS BY REGAL-BELOIT HVAC MOTORS

DIRECT DRIVE FAN & BLOWER

Single Phase



Cat. #3852

Features

- Multiple mounting capability
- Mounting holes in shell for capacitor bracket
- Designed for 370 Volt capacitor (not furnished)
- Automatic thermal overload protection

Applications

Designed for continuous air over applications, such as room air conditioners, unit coolers, and other air moving applications with double shaft requirements.

Permanent Split Capacitor - 5 1/2" Diameter - Open - Double Shaft

HP	RPM	Speed	Volts	Base	Rotation	FLA @ NP	Catalog No.	C Dim.	Notes
1/10	1075/900/750	3	208-230	1RR	CCW	0.8	3632	20.00	4, 7
	1075	3	115	1RR	CCW	1.2	3631	20.00	4, 7
1/8	1075	3	115	1RR	CCW	1.8	3641	20.00	4, 7
	1075	3	208-230	1RR	CCW	0.8	3642	20.00	4, 7
1/6	1625	3	115	1RR	CCW	2.0	3851	20.00	4, 7
	1625	3	208-230	1RR	CCW	0.9	3852	20.00	4, 7
	1075	3	115	1RR	CCW	2.4	3651	20.00	4
	1075	3	208-230	1RR	CCW	1.0	3652	20.00	4, 7
	1075	3	208-230	NB	CCW	1.0	3656	20.00	4, 8
	1075	3	208-230	1RR	CCW	1.1	3862	20.00	4, 7
1/5	1625	3	208-230	1RR	CCW	1.1	3862	20.00	4, 7
1/4	1625	3	115	1RR	CCW	2.9	3871	20.00	4, 7
	1625	3	208-230	1RR	CCW	1.2	3872	20.00	4, 7
	1075	3	115	1RR	CCW	3.7	3671	20.00	4, 7
	1075	3	208-230	1RR	CCW	1.7	3672	20.00	4, 7
	1075	3	208-230	NB	CCW	1.7	3676	20.00	4, 8
	825	3	208-230	1RR	CCW	1.9	3094	20.00	4, 7
1/3	1625	3	115	1RR	CCW	4.1	3881	20.00	4, 7
	1625	3	208-230	1RR	CCW	1.9	3882	20.00	4, 7
	1075	3	115	1RR	CCW	5.1	3681	20.00	4, 7
	1075	2	208-230	RB	CCW	2.4	3091	22.00	4
	1075	3	208-230	1RR	CCW	2.5	3682	20.00	4, 7
	1075	3	208-230	NB	CCW	2.5	3686	20.00	4, 8
	825	3	208-230	1RR	CCW	2.8	3103	20.00	4, 7
1/2	1625	3	115	1RR	CCW	6.4	3891	20.00	4, 7
	1625	3	208-230	1RR	CCW	3.0	3892	20.00	4, 7
	1075	3	115	1RR	CCW	7.3	3691	20.00	4, 7
	1075	2	208-230	RB	CCW	3.8	3092	23.00	4
	1075	3	208-230	1RR	CCW	3.5	3692	20.00	4, 7
	1075	3	208-230	NB	CCW	3.5	3696	20.00	4, 8
	3/4	1625	3	208-230	1RR	CCW	3.9	3898	20.00
1075	3	208-230	1RR	CCW	5.0	3698	20.00	1, 4, 11	

NOTES: 1 = 5/8" shaft adapter included; 4 = Sleeve bearing; 8 = Mounting accessories and resilient ring for pulley and end are not included.

Use accessory kit 16L131AB1 for resilient ring mounting; 7 = Length adapter kit; 11 = Shaft extension 3/8" dia.



GE Commercial Motors

By Regal-Beloit

GE COMMERCIAL MOTORS BY REGAL-BELOIT HVAC MOTORS
DIRECT DRIVE FAN & BLOWER
Single Phase

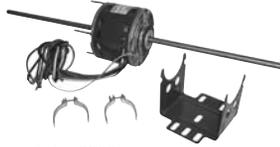

Cat. #2830

Features

- Multiple mounting capability
- Mounting holes in shell for capacitor bracket
- Designed for 370 Volt capacitor (not furnished)
- Automatic thermal overload protection

Applications

Designed for continuous air over applications, such as room air conditioners, unit coolers, and other air moving applications with double shaft requirements.

Permanent Split Capacitor - 5" Diameter - Open - Double Shaft

HP	RPM	Speed	Volts	Base	Rotation	FLA @ NP	Catalog No.	C Dim.	Notes
1/15	1075	4	115	2RR	CCW	1.4	2830	26.00	4
1/10	1625	4	115	2RR	CCW	1.3	2835	21.50	4
	1075	4	115	2RR	CCW	1.9	2831	21.30	4
1/8	1075	4	115	2RR	CCW	2.7	2832	25.50	4
	1075	4	208-230	2RR	CCW	1.1	2836	25.50	4
1/6	1625	4	115	2RR	CCW	2.1	2837	21.80	4
1/4	1075	4	115	2RR	CCW	4.7	2833	22.50	4
	1075	4	208-230	2RR	CCW	2.1	2834	22.50	4

NOTES: 4 = Sleeve bearing.

GE COMMERCIAL MOTORS BY REGAL-BELOIT HVAC MOTORS
DIRECT DRIVE FAN & BLOWER
Single Phase



Cat. #3470

Features

- Extended clamp screws
- Automatic thermal overload protection
- Designed for 50Hz or 60Hz operation

Applications

Designed for continuous air over applications, such as high voltage fan and blower systems.

Permanent Split Capacitor - 5 1/2" Diameter - Open - Single Shaft - 460 Volt

HP	RPM	Speed	Volts	Base	Rotation	FLA @ NP	Catalog No.	C Dim.	Notes
1/4	1625	2	460	NB	CCW/CW	0.8	3470	11.40	14
1/3	1075	2	460	NB	CCW/CW	1.1	3280	11.60	14
1/2	1625	2	460	NB	CCW/CW	1.7	3490	12.40	14
3/4	1075	2	460	NB	CCW/CW	2.1	3290	12.40	14

NOTES: 14 = Ball bearing.



GE Commercial Motors

By Regal-Beloit

GE COMMERCIAL MOTORS BY REGAL-BELOIT HVAC MOTORS

DIRECT DRIVE FAN & BLOWER

Single Phase



Features

- Designed for 370 Volt capacitor (not furnished)
- Automatic thermal overload protection

Applications

Designed for continuous air over applications, such as high voltage fan and blower systems.

Cat. #2820

Permanent Split Capacitor - 5" Diameter - Open - Single Shaft

HP	RPM	Speed	Volts	Base	Rotation	FLA @ NP	Catalog No.	C Dim.	Notes
1/30	1075	3	115	RB	CCW/CW	0.6	2840	12.90	4, 7
1/8	1075	1	115	2RR	CCW/CW	2.6	2820	9.40	4
	1075	3	115	2RR	CCW/CW	2.5	2824	9.40	4
1/6	1075	1	115	2RR	CCW/CW	3.0	2821	9.70	4
1/5	1075	1	115	2RR	CCW/CW	3.5	2822	9.90	4
	1075	3	115	2RR	CCW/CW	3.5	2825	9.90	4
	1075	3	208-230	2RR	CCW/CW	1.7	2826	9.90	4
1/4	1075	1	115	2RR	CCW/CW	4.7	2823	10.20	4
	1075	3	115	2RR	CCW/CW	4.8	2827	10.20	4
	1075	3	208-230	2RR	CCW/CW	2.2	2828	10.20	4
1/3	1075	3	115	2RR	CCW/CW	5.8	2829	10.20	4

Permanent Split Capacitor - 5 1/2" Diameter - Open - Single Shaft

1/6	1625	1	208-230	2RR	CCW	0.9	3452	8.60	4
	1150	1	115/230	2RR	CCW	2.6/1.3	3453	8.89	4, 12
	1075	1	115	2RR	CCW	2.3	3251	8.60	4
	1075	1	208-230	2RR	CCW/CW	0.9	3252	8.60	4
	1050	1	115/230	2RR	CCW	2.2/1.1	3454	8.89	4, 12
1/5	1050	3	115	2RR	CCW	2.6	3455	8.64	4, 12
1/4	1625	1	115	2RR	CCW	3.2	3471	9.10	4
	1625	1	208-230	2RR	CCW	1.4	3472	9.10	4
	1075	1	115	2RR	CCW	3.5	3271	8.90	4
	1075	1	208-230	2RR	CCW/CW	1.5	3272	9.10	4
1/3	1625	1	115	2RR	CCW	4.7	3481	9.60	4
	1625	1	208-230	2RR	CCW	2.2	3482	9.60	4
	1075	1	115	2RR	CCW	5.0	3281	9.60	4
	1075	1	208-230	2RR	CCW/CW	2.4	3282	9.60	4
1/2	1075	1	208-230	2RR	CCW	3.4	3292	10.10	4

NOTES: 4 = Sleeve bearing; 7 = Length adapter kit included; 12 = Designed for 50 or 60 Hz operation.



GE Commercial Motors

By Regal-Beloit

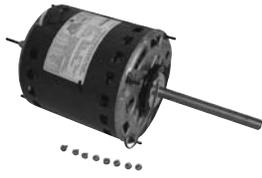

Cat. #3466

Features

- Energy Saver Plus design (♦)
- Permanent split capacitor
- Automatic thermal overload protection
- Ball and sleeve bearings
- Rheem mounting holes (mounting hardware included)
- Different capacitor/speed combinations to fit various HP applications
- Class B insulation
- Extended clamp screws and resilient rings to fit multiple mounting requirements

Applications

Designed for continuous air over applications, such as direct drive residential, commercial and industrial air conditioners, fan and blowers.

Direct Drive Fan & Blower

HP	RPM	Speed	Volts	Base	Rotation	FLA @ NP	Catalog No.	C Dim.	Notes
1/2-1/6	1075	4	115	2RR	CCW/CW	6.2	3463 ♦	10.64	4, 15
1/2-1/6	1075	4	208-230	2RR	CCW/CW	2.7	3464 ♦	10.64	4, 15
3/4-1/5	1075	4	115	2RR	CCW/CW	8.5	3466 ♦	11.89	14, 15
3/4-1/5	1075	4	208-230	2RR	CCW/CW	4.2	3467 ♦	11.14	14, 15

NOTES: 4 = Sleeve bearing; 14 = Ball bearing; 15 = Rheem mounting holes in shell.

Capacitor/Speed Selection Guide

Catalog# 3464 - 1/2 HP Direct Drive Motors

Motor HP	Capacitor	Speeds to Use	FLA
1/2	10/370	All Speeds	2.7
1/3	5/370 or 7.5/370 *	All Speeds	2.6
1/4	5/370 or 7.5/370 *	Med-Hi Med-Lo:Lo	1.9
1/5	5/370 or 7.5/370 *	Med-Lo:Lo	1.4
1/6	5/370 or 7.5/370 *	Lo	1.1

Catalog# 3463 - 1/2 HP Direct Drive Motors

Motor HP	Capacitor	Speeds to Use	FLA
1/2	15/370	All Speeds	6.2
1/3	5/370 or 7.5/370 *	All Speeds	6.1
1/4	5/370 or 7.5/370 *	Med-Hi Med-Lo:Lo	4.0
1/5	5/370 or 7.5/370 *	Med-Lo:Lo	2.9
1/6	5/370 or 7.5/370 *	Lo	2.2

*Using a 7.5 MFD/370V capacitor will result in approximately 10% stronger motor

Catalog# 3466 - 3/4 HP Direct Drive Motors

Motor HP	Capacitor	Speeds to Use	FLA
3/4	20/370	All Speeds	8.5
1/2	10/370	All Speeds	8.3
1/3	10/370	Med-Hi Med-Lo:Lo	4.6
1/4	10/370	Med-Lo:Lo	3.4
1/5	10/370	Lo	2.7

Catalog# 3467 - 3/4 HP Direct Drive Motors

Motor HP	Capacitor	Speeds to Use	FLA
3/4	20/370	All Speeds	4.2
1/2	10/370	All Speeds	3.8
1/3	10/370	Med-Hi Med-Lo:Lo	2.3
1/4	10/370	Med-Lo:Lo	1.9
1/5	10/370	Lo	1.5



GE COMMERCIAL MOTORS BY REGAL-BELOIT HVAC MOTORS
LIFE-LINE™ STANDARD MULTI-HORSEPOWER MOTORS



Cat. #3465

Features

- Permanent split capacitor
- Automatic thermal overload protection
- Water slinger on shaft
- Different capacitor/speed combinations to fit various HP applications
- Class B insulation
- Designed for 370 Volt capacitor
- Rheem mounting holes (mounting hardware included)
- Extended clampbolts or studs for mounting

Applications

Designed for condenser fan and heat pump units requiring vertical shaft up or vertical shaft down positioning with “belly band” or extended clamp screw mounting.

Condenser Fan & Heat Pump

HP	RPM	Speed	Volts	Base	Rotation	FLA @ NP	Catalog No.	C Dim.	Notes
1/3-1/6	1075	2	208-230	NB	CCW/CW	6.2	3465	9.80	14, 15
		1	208-230	NB	CCW/CW	2.7	3458	11.05	14, 15
1/3-1/6	825	2	208-230	NB	CCW/CW	8.4	3469	11.89	14, 15
		1	208-230	NB	CCW/CW	1.9	3459	11.14	14, 15
1/2-1/5	1075	2	208-230	NB	CCW/CW	4.2	3468	11.14	14, 15

NOTES: 14 = Ball bearing; 15 = Rheem mounting holes in shell.

Capacitor/Speed Selection Guide

Model 3465 – 1075 RPM – 1/3 HP

Motor HP	Speeds to Use	208V Capacitor	230V Capacitor	FLA
1/3	Hi	7.5/370	5/370	2.6
1/4	Hi	7.5/370	5/370	2.5
1/5	Lo	7.5/370	5/370	2.0
1/6	Lo	7.5/370	5/370	1.8

Model 3459 – 825 RPM – 1/3 HP

Motor HP	Speeds to Use	208V Capacitor	230V Capacitor	FLA
1/3	Hi	10.0/370	10.0/370	1.9
1/4	Hi	10.0/370	10.0/370	1.6
1/5	Hi	10.0/370	10.0/370	1.4
1/6	Hi	10.0/370	10.0/370	1.2
1/8	Hi	10.0/370	10.0/370	1.0

Model 3458 – 1075 RPM – 1/3 HP

Motor HP	Speeds to Use	208V Capacitor	230V Capacitor	FLA
1/3	Hi	7.5/370	7.5/370	2.8
1/4	Hi	7.5/370	7.5/370	2.2
1/5	Hi	7.5/370	7.5/370	1.9
1/6	Hi	7.5/370	7.5/370	1.7

Model 3468 – 1075 RPM – 1/2 HP

Motor HP	Speeds to Use	208V Capacitor	230V Capacitor	FLA
1/2	Hi	12.5/370	10/370	3.0
1/3	Hi	12.5/370	10/370	2.2
1/4	Lo	12.5/370	10/370	1.6
1/5	Lo	12.5/370	10/370	1.3

Model 3469 – 825 RPM – 1/3 HP

Motor HP	Speeds to Use	208V Capacitor	230V Capacitor	FLA
1/3	Hi	10/370	7.5/370	2.2
1/4	Hi	10/370	7.5/370	2.0
1/5	Lo	10/370	7.5/370	1.3
1/6	Lo	10/370	7.5/370	1.2



GE Commercial Motors

By Regal-Beloit

**GE COMMERCIAL MOTORS BY REGAL-BELOIT HVAC MOTORS
LIFE-LINE™ HEATSHIELD™ MULTI-HORSEPOWER MOTORS**

Life-Line™



Cat. #3456HS

Features

- Motors designed for 70° C Ambient
- Runs cooler, more efficient than competition
- Lower motor operating temperatures = improved life & reliability
- New & improved reversing plug
- Increased lead length to 48"
- Improved shaft water thrower
- Upper NEMA band BDT designs
- All-angle mounting position
- Rheem mounting holes (mounting hardware included)
- Quick Connects on capacitor leads
- Lead exit seal bushing
- Extended thru bolts on both ends
- Reversible rotation
- Drain holes in both endshields with plugs

Applications

Designed for condenser fan and heat pump units requiring vertical shaft up or vertical shaft down positioning with "belly band" or extended clamp screw mounting.

Condenser Heat Pump - Multi-Horsepower 4-in-1 - Ball Bearing

HP	RPM	Speed	Volts	Rotation	Capacitor Rating	Amps	Catalog No.	C Dim.	Notes
1/3-1/6	1075	1	208-230	CCW/CW	7.5/370V	2.6	3458HS	12.21	14, 15
1/3-1/6	1075	2	208-230	CCW/CW	5.0/370V	2.5	3465HS	12.21	14, 15
1/3-1/6	825	2	208-230	CCW/CW	7.5/370V	2.0	3469HS	12.96	14, 15
1/3-1/8	825	1	208-230	CCW/CW	10.0/370V	1.8	3459HS	12.46	14, 15

NOTES: 14 = Ball bearing; 15 = Rheem mounting holes in shell.

Capacitor/Speed Selection Guide

Model 3458HS - Connection Instructions

Motor HP	Speeds to Use	208V Capacitor	230V Capacitor	FLA
1/3	Hi	7.5/370	7.5/370	2.6
1/4	Hi	7.5/370	7.5/370	2.0
1/5	Hi	7.5/370	7.5/370	1.8
1/6	Hi	7.5/370	7.5/370	1.6

Model 3469HS - Connection Instructions

Motor HP	Speeds to Use	208V Capacitor	230V Capacitor	FLA
1/3	Hi	10/370	7.5/370	2.0
1/4	Hi	10/370	7.5/370	1.8
1/5	Lo	10/370	7.5/370	1.3
1/6	Lo	10/370	7.5/370	1.1

Model 3465HS - Connection Instructions

Motor HP	Speeds to Use	208V Capacitor	230V Capacitor	FLA
1/3	Hi	7.5/370	5/370	2.5
1/4	Hi	7.5/370	5/370	2.0
1/5	Lo	7.5/370	5/370	1.6
1/6	Lo	7.5/370	5/370	1.4

Model 3459HS - Connection Instructions

Motor HP	Speeds to Use	208V Capacitor	230V Capacitor	FLA
1/3	Hi	10/370	10/370	1.8
1/4	Hi	10/370	10/370	1.5
1/5	Hi	10/370	10/370	1.3
1/6	Hi	10/370	10/370	1.2
1/8	Hi	10/370	10/370	1.0



GE Commercial Motors

By Regal-Beloit

**GE COMMERCIAL MOTORS BY REGAL-BELOIT HVAC MOTORS
LIFE-LINE™ HEATSHIELD™ MULTI-HORSEPOWER MOTORS**

Life-Line™



Cat. #3468HS

Features

- Motors designed for 70° C Ambient
- Runs cooler, more efficient than competition
- Lower motor operating temperatures = improved life & reliability
- New & improved reversing plug
- Increased lead length to 48"
- Improved shaft water thrower
- Upper NEMA band BDT designs
- All-angle mounting position
- Rheem mounting holes (mounting hardware included)
- Quick Connects on capacitor leads
- Lead exit seal bushing
- Extended thru bolts on both ends
- Reversible rotation
- Drain holes in both endshields with plugs



Applications

Designed for condenser fan and heat pump units requiring vertical shaft up or vertical shaft down positioning with "belly band" or extended clamp screw mounting.

Condenser Heat Pump - Multi-Horsepower 4-in-1 - Ball Bearing

HP	RPM	Speed	Volts	Rotation	Capacitor Rating	Amps	Catalog No.	C Dim.	Notes
1/2-1/6	1075	1	208-230	CCW/CW	10.0/370V	3.0	3460HS	12.96	14, 15
1/2-1/6	825	1	208-230	CCW/CW	20/370V	2.8	3461HS	13.46	14, 15
1/2-1/5	1075	2	208-230	CCW/CW	10.0/370V	3.1	3468HS	12.96	14, 15
1/3-1/6	1075	1	208-230	CCW/CW	7.5/370V	2.6	3456HS	12.21	4, 15
1/3-1/8	825	1	208-230	CCW/CW	10/370V	1.8	3457HS	12.46	4, 15

Capacitor/Speed Selection Guide

Model 3460HS - Connection Instructions

Motor HP	Speeds to Use	208V Capacitor	230V Capacitor	FLA
1/2	Hi	10/370	10/370	3.0
1/3	Hi	10/370	10/370	2.3
1/4	Hi	10/370	10/370	1.8
1/5	Hi	10/370	10/370	1.6
1/6	Hi	10/370	10/370	1.4

Model 3468HS - Connection Instructions

Motor HP	Speeds to Use	208V Capacitor	230V Capacitor	FLA
1/2	Hi	12.5/370	10/370	3.1
1/3	Hi	12.5/370	10/370	2.3
1/4	Lo	12.5/370	10/370	1.5
1/5	Lo	12.5/370	10/370	1.2

Model 3461HS - Connection Instructions

Motor HP	Speeds to Use	208V Capacitor	230V Capacitor	FLA
1/2	Hi	20/370	20/370	2.8
1/3	Hi	20/370	20/370	2.2
1/4	Hi	20/370	20/370	2.0
1/5	Hi	20/370	20/370	1.8
1/6	Hi	20/370	20/370	1.6

Stock #3456HS - Connection Instructions

Motor HP	Speeds to Use	208V Capacitor	230V Capacitor	FLA
1/3	Hi	7.5/370	7.5/370	2.6
1/4	Hi	7.5/370	7.5/370	2.0
1/5	Hi	7.5/370	7.5/370	1.8
1/6	Hi	7.5/370	7.5/370	1.6

Stock #3457HS - Connection Instructions

Motor HP	Speeds to Use	208V Capacitor	230V Capacitor	FLA
1/3	Hi	10 / 370	10 / 370	1.8
1/4	Hi	10 / 370	10 / 370	1.5
1/5	Hi	10 / 370	10 / 370	1.3
1/6	Hi	10 / 370	10 / 370	1.2
1/8	Hi	10 / 370	10 / 370	1.0



GE Commercial Motors

By Regal-Beloit

**GE COMMERCIAL MOTORS BY REGAL-BELOIT HVAC MOTORS
HEATSHIELD™ MOTORS**



Cat. #3202HS

Features

- Motors designed for 70° C Ambient
- Runs cooler, more efficient than competition
- Lower motor operating temperatures = improved life & reliability
- New & improved reversing plug
- Increased lead length to 48"
- Improved shaft water thrower
- Upper NEMA band BDT designs
- All-angle mounting position
- Rheem mounting holes (mounting hardware included)
- Quick Connects on capacitor leads
- Lead exit seal bushing
- Extended thru bolts on both ends
- Reversible rotation
- Drain holes in both endshields with plugs

Applications

Designed for continuous air over applications, such as direct drive residential, commercial and industrial air conditioners, fan and blowers.

Outdoor Condenser Fan

HP	RPM	Speeds	Volts	Rotation	Capacitor Rating	Amps	Catalog No.	C Dim.	Notes
1/8	825	1	208-230	CCW/CW	5/370V	0.85	3725HS	11.21	4, 15
	825	1	208-230	CCW/CW	5/370V	0.85	3202HS	11.21	14, 15
1/6	1075	1	208-230	CCW/CW	5/370V	1.0	3727HS	10.96	4, 15
	1075	1	208-230	CCW/CW	5/370V	1.0	3726HS	10.96	14, 15
	825	1	208-230	CCW/CW	5/370V	0.9	3403HS	11.71	4, 15
1/4	825	1	208-230	CCW/CW	5/370V	0.9	3203HS	11.71	14, 15
	1625	2	208-230	CCW/CW	5/370V	1.8	3C001	11.46	14, 15
	1075	1	208-230	CCW/CW	5/370V	1.7	3728HS	11.46	4, 15
	1075	1	208-230	CCW/CW	5/370V	1.7	3732HS	11.46	14, 15
	825	1	208-230	CCW/CW	7.5/370V	1.3	3404HS	11.96	4, 15
1/3	825	1	208-230	CCW/CW	7.5/370V	1.3	3204HS	11.96	14, 15
	1625	2	208-230	CCW/CW	5/370V	1.8	3C002	11.96	14, 15
	1075	1	208-230	CCW/CW	7.5/370V	2.6	3729HS	12.21	4, 15
	1075	1	208-230	CCW/CW	7.5/370V	2.6	3733HS	12.21	14, 15
	825	1	208-230	CCW/CW	10/370V	1.8	3405HS	12.46	4, 15
1/2	825	1	208-230	CCW/CW	10/370V	1.8	3205HS	12.46	14, 15
	1625	2	208-230	CCW/CW	7.5/370V	1.2	3C003	12.71	14, 15
	1075	1	208-230	CCW/CW	10/370V	3.0	3730HS	12.96	4, 15
	1075	1	208-230	CCW/CW	10/370V	3.0	3734HS	12.96	14, 15
	825	1	208-230	CCW/CW	20/370V	2.8	3746HS	13.46	4, 15
3/4	825	1	208-230	CCW/CW	20/370V	2.8	3747HS	13.46	14, 15
	1075	1	208-230	CCW/CW	15/370V	4.1	3731HS	13.21	4, 15
	1075	1	208-230	CCW/CW	15/370V	4.1	3735HS	13.21	14, 15

Outdoor Condenser Fan - Commercial 460 Volt

1/4	1075	1	460	CCW/CW	7.5/370V	0.7	3736HS	11.46	14, 15
1/3	1075	1	460	CCW/CW	7.5/370V	1.2	3737HS	12.46	14, 15
1/2	1075	1	460	CCW/CW	10/370V	1.7	3738HS	12.96	14, 15
3/4	1075	1	460	CCW/CW	10/370V	2.0	3739HS	13.21	14, 15

NOTES: 4 = Sleeve bearing; 14 = Ball bearing; 15 = Rheem mounting holes in shell.



GE Commercial Motors

By Regal-Beloit

GE COMMERCIAL MOTORS BY REGAL-BELOIT HVAC MOTORS

CONDENSER FAN & HEAT PUMP

Single Phase



Cat. #3028

Cat. #3084

Features

- Extended clamp screws
- Automatic thermal overload protection

Applications

Designed for condenser fan and heat pump units requiring vertical shaft up or vertical shaft down positioning with “belly band” or extended clamp screw mounting.

Permanent Split Capacitor – Shaft Up or Horizontal Application

HP	RPM	Speeds	Volts	Base	Rotation	FLA @ NP	Cat. No.	C Dim.	Notes
1/6	1075	2	208-230	NB	CCW/CW	0.9	3027	10.63	2, 4, 9
		1	208-230	NB	CCW/CW	0.9	3327	10.63	2, 4, 5, 9
	825	1	208-230	NB	CCW/CW	1.0	3200	11.14	2, 9, 14
1/4	1075	2	208-230	NB	CCW/CW	1.5	3028	11.13	2, 4, 9
		2	208-230	NB	CCW/CW	1.5	3046	10.89	2, 4, 9, 14
	1075	1	208-230	NB	CCW/CW	1.8	3328	11.13	4, 5, 9
		825	1	208-230	NB	CCW/CW	2.2	3040	11.64
1/3	1075	2	208-230	NB	CCW/CW	2.1	3029	11.88	2, 4, 9
		2	208-230	NB	CCW/CW	2.1	3031	11.64	2, 4, 9, 14
	1075	1	208-230	NB	CCW/CW	2.4	3329	11.38	2, 4, 5, 9
		825	1	115	NB	CCW/CW	4.4	3049	12.89
	825	1	208-230	NB	CCW/CW	2.2	3026	12.14	2, 9, 14
		1	460	NB	CCW/CW	1.1	3035	12.39	2, 9, 14
1/2	1075	2	208-230	NB	CCW/CW	3.5	3030	12.38	4, 9
		1	208-230	NB	CCW/CW	3.6	3330	11.88	2, 4, 5, 9
	1075	2	208-230	NB	CCW/CW	3.5	3032	12.14	2, 9, 14
		825	1	208-230	NB	CCW/CW	3.0	3034	12.14
	825	1	460	NB	CCW/CW	1.6	3036	12.64	2, 9, 14
3/4	1075	1	208-230	NB	CCW/CW	5.1	3331	12.63	2, 4, 9
		1	208-230	NB	CCW/CW	5.1	3037	12.64	9, 14
	1075	2	208-230	NB	CCW/CW	4.1	3048	12.64	2, 9, 14
		2	208-230	NB	CCW/CW	4.1	3038	12.89	2, 4, 9, 12

Permanent Split Capacitor – Shaft Down Application

1/4	1075	1	208-230	NB	CCW/CW	1.5	3084	10.95	12, 14
1/3	1075	1	208-230	NB	CCW/CW	2.1	3085	11.45	12, 14
1/2	1075	1	208-230	NB	CCW/CW	3.1	3086	11.95	12, 14

NOTES: 2 = 6" shaft extension with two flats 90° apart; 4 = Sleeve bearing; 5 = Designed for 60° C ambient; 9 = Opposite shaft-end endshield is open; 12 = Designed for 50 or 60 Hz operation; 14 = Ball bearing.



GE COMMERCIAL MOTORS BY REGAL-BELOIT HVAC MOTORS

CONDENSER FAN & HEAT PUMP

Single Phase



Cat. #3228

Features

- Heatshield version available (-)
- Sleeve or ball bearings
- 26" motor leads
- Water Slinger on shaft
- 6" shaft extension with 2 flats 90° apart
- Designed for 370 Volt capacitor

Applications

Designed for condenser fan and heat pump units requiring vertical shaft up or vertical shaft down positioning with "belly band" or extended clamp screw mounting.

Permanent Split Capacitor – Shaft Up Or Down Application

HP	RPM	Speeds	Volts	Base	Rotation	FLA @ NP	Cat. No.	C Dim.	Notes
1/10	825	1	208-230	NB	CCW/CW	0.7	3201	10.31	5, 12, 14
1/8	825	1	208-230	NB	CCW/CW	1.1	3202	10.31	5, 12, 14
1/6	1075	2	208-230	NB	CCW/CW	1.0	3227	10.45	4
	1075	1	208-230	NB	CCW/CW	1.0	3727	10.70	4
	825	1	208-230	NB	CCW/CW	1.0	3203	10.31	14
	825	1	208-230	NB	CCW/CW	1.0	3403	10.31	4
1/4	1075	2	208-230	NB	CCW/CW	1.6	3228	10.95	4
	1075	2	208-230	NB	CCW/CW	1.6	3428	11.56	14
	1075	1	208-230	NB	CCW/CW	1.8	3728	10.70	4, 5
	1075	1	208-230	NB	CCW/CW	1.8	3732	10.30	5, 14
	1075	1	460	NB	CCW/CW	0.9	3736	10.89	14
	825	1	208-230	NB	CCW/CW	1.5	3204	11.31	14
	825	1	208-230	NB	CCW/CW	1.5	3404	11.31	4
1/3	1075	2	208-230	NB	CCW/CW	2.4	3229	11.45	4
	1075	2	208-230	NB	CCW/CW	2.4	3429	12.06	14
	1075	1	208-230	NB	CCW/CW	2.3	3729	11.70	4, 5, 13
	1075	1	208-230	NB	CCW/CW	2.3	3733	11.71	5, 14
	1075	1	460	NB	CCW/CW	1.3	3737	12.31	14
	1075	1	575	NB	CCW/CW	1.1	3759	11.70	4
	825	1	208-230	NB	CCW/CW	2.2	3205	11.81	14
	825	1	460	NB	CCW/CW	1.1	3209	11.71	14
	825	1	208-230	NB	CCW/CW	2.2	3405	11.81	4
	1/2	1075	2	208-230	NB	CCW/CW	3.8	3230	12.45
1075		2	208-230	NB	CCW/CW	3.8	3430	13.06	14
1075		1	208-230	NB	CCW/CW	3.5	3730	12.20	4, 5
1075		1	208-230	NB	CCW/CW	3.5	3734	12.21	14
1075		1	460	NB	CCW/CW	1.7	3738	12.81	5, 14
1075		1	575	NB	CCW/CW	1.5	3760	12.20	4
825		1	460	NB	CCW/CW	1.8	3740	12.96	14
825		1	208-230	NB	CCW/CW	3.2	3746	12.71	4
825		1	208-230	NB	CCW/CW	2.8	3747HS ~	13.46	14
3/4	1075	2	208-230	NB	CCW/CW	4.7	3431	13.06	14
	1075	1	208-230	NB	CCW/CW	4.7	3731	12.70	4
	1075	1	208-230	NB	CCW/CW	4.7	3735	12.71	14
	1075	1	460	NB	CCW/CW	2.0	3739	13.31	14

NOTES: 4 = Sleeve bearing; 5 = Designed for 60° C ambient; 6 = Designed for 65° C ambient; 12 = Designed for 50 or 60 Hz operation; 13 = TENV construction; 14 = Ball bearing.



GE COMMERCIAL MOTORS BY REGAL-BELOIT HVAC MOTORS

UNIT HEATER FANS

Single Phase



Cat. #3212

Features

- 5" shaft extension
- Mounting holes in shell for capacitor bracket
- Automatic thermal overload protection
- 370 Volt capacitor kit included
- Resilient base kit included (3" shaft height)
- 60" motor leads

Applications

Designed for replacement of unit heater fan motors.

Permanent Split Capacitor – 5 1/2" Diameter With Accessories Kit

HP	RPM	Speeds	Volts	Base	Rotation	FLA @ NP	Cat. No.	C Dim.	Notes
1/6	1075	1	115	2RR	CCW/CW	2.2	3206	10.10	12, 14
1/4	1075	1	115	2RR	CCW/CW	3.3	3208	10.40	12, 14
	1075	1	208-230	2RR	CCW/CW	1.4	3210	10.40	12, 14
1/3	1075	1	115	2RR	CCW/CW	4.9	3212	11.40	12, 14
	1075	1	208-230	2RR	CCW/CW	2.0	3214	11.40	12, 14

NOTES: 12 = Designed for 50 or 60 Hz operation; 14 = Ball bearing.

GE COMMERCIAL MOTORS BY REGAL-BELOIT HVAC MOTORS

21/29 FRAME REPLACEMENT

Single Phase



Cat. #2925

Features

- Resilient rings for base mounting
- Tapped holes for shaft end mounting
- Automatic thermal overload protection

Applications

Designed for use on unit heaters and coolers, commercial condensing units and space heaters.

Permanent Split Capacitor – Totally Enclosed – Single Shaft

HP	RPM	Speeds	Volts	Base	Rotation	FLA @ NP	Cat. No.	C Dim.	Notes
1/15	1550	1	115	2RR	CCW/CW	1.30	2925	6.45	3, 4, 7, 11
	1550	1	208-230	2RR	CCW/CW	0.65	2950	6.45	3, 4, 7, 11
	1050	1	115	2RR	CCW/CW	1.60	2926	6.45	3, 4, 7, 11
	1050	1	208-230	2RR	CCW/CW	0.65	2952	6.45	3, 4, 7, 11
1/12	1550	1	115	2RR	CCW/CW	1.60	2927	7.95	3, 4, 11
	1550	1	208-230	2RR	CCW/CW	0.70	2953	7.95	3, 4, 11
	1050	1	115	2RR	CCW/CW	1.85	2928	7.95	3, 4, 11
	1050	1	208-230	2RR	CCW/CW	0.70	2954	7.95	3, 4, 11

NOTES: 3 = Capacitor supplied with motor; 4 = Sleeve bearing; 7 = Length adapter kit included; 11 = Shaft extension 3/8" dia..

GE COMMERCIAL MOTORS BY REGAL-BELOIT HVAC MOTORS

CONDENSER FAN & HEAT PUMP - CAP-CAN CONSTRUCTION

Single Phase



Cat. #2243

Features

- "Cap-Can" construction
- Automatic thermal overload protection
- Extended studs or flange mount
- Vertical shaft down application
- CW or CCW rotation in several ratings
- Designed for 370 volt capacitor (not included)
- Continuous duty, air-over
- Class B insulation
- Water slinger on shaft

Applications

Designed for use in residential outdoor condenser fan and heat pump units (primarily up to 3.5 tons).

Permanent Split Capacitor – 5" Diameter – Totally Enclosed Air Over

HP	RPM	Speeds	Volts	Base	Rotation	FLA @ NP	Cat. No.	C Dim.	Notes
1/10	1100	1	208-230	NB	CW	0.74	2243	6.10	14
1/8	1075	1	208-230	NB	CW	0.86	2248	6.10	14
	1075	1	208-230	NB	CCW	0.75	2249	6.10	14
1/6	1100	1	208-230	NB	CCW	1.30	2247	6.70	14
1/5	1060	1	208-230	NB	CW	1.60	2246	6.51	14
1/4	1075	1	208-230	NB	CW	1.70	2244	6.70	14
	1075	1	208-230	NB	CCW	1.70	2245	6.70	14

NOTES: 14 = Ball bearing.



GE Commercial Motors

By Regal-Beloit

OEM REPLACEMENT MOTORS



American Air Filter – Model Number 5KCP39KGB909S

HP	RPM	Volts	Base	Rotation	Catalog No.	Dimensions		
						A	B	C
1/8	700	115	RB	CW	3134	-	1.50	7.89
Enclosure		Speeds	FLA @ NP		Frame	Bearings	Run Cap Mfd.	
OPAO		1	2.0		39	Sleeve	5	

Replaces GE Commercial Motors by Regal-Beloit OEM model: 5KCP36KB246S, 5KCP36KG317S, 5KCP36KG583S, 5KCP38PG200S



American Standard – Model Number 5KCP39HG728S

HP	RPM	Volts	Base	Rotation	Catalog No.	Dimensions		
						A	B	C
1/3	1075	230	RB	CCW	3114	-	3.25	8.39
Enclosure		Speeds	FLA @ NP		Frame	Bearings	Run Cap Mfd.	
OPAO		1	3.3		39	Sleeve	4	

Replaces GE Commercial Motors by Regal-Beloit OEM model: 5KCP39HG3692S



Carrier - Model Number 5KCP39BGY916S

HP	RPM	Volts	Base	Rotation	Catalog No.	Dimensions		
						A	B	C
1/15	800	208-230	NB	CW	3S002	-	1.50	5.71
Enclosure		Speeds	FLA @ NP		Frame	Bearings	Run Cap Mfd.	
TENV		1			39	Sleeve	5	

Replaces GE Commercial Motors by Regal-Beloit OEM model: 5KCP39BGV573AS



Carrier - Model Number 5KCP39BGY825S

HP	RPM	Volts	Base	Rotation	Catalog No.	Dimensions		
						A	B	C
1/12	1075	208-230	ECS	CW	3908	5.63	5.63	16.42
Enclosure		Speeds	FLA @ NP		Frame	Bearings	Run Cap Mfd.	
OPAO		1	1.2		39	Sleeve	5	

Replaces GE Commercial Motors by Regal-Beloit OEM model: 5KCP39BGS162S



Carrier - Model Number 5KCP39BGY824S

HP	RPM	Volts	Base	Rotation	Catalog No.	Dimensions		
						A	B	C
1/10	1100	208-230	ECS	CW	3907	-	1.50	5.71
Enclosure		Speeds	FLA @ NP		Frame	Bearings	Run Cap Mfd.	
TEAO		1	0.75		39	Sleeve	5	

Replaces GE Commercial Motors by Regal-Beloit OEM model: 5KCP39BGS069S



Carrier - Model Number 5KCP39BGY915S

HP	RPM	Volts	Base	Rotation	Catalog No.	Dimensions		
						A	B	C
1/10	1100	208-230	NB	CW	3S001	-	1.50	5.71
Enclosure		Speeds	FLA @ NP		Frame	Bearings	Run Cap Mfd.	
TENV		1			39	Sleeve	5	

Replaces GE Commercial Motors by Regal-Beloit OEM model: 5KCP39BGS069S



Carrier - Model Number 5KCP39CGP031S

HP	RPM	Volts	Base	Rotation	Catalog No.	Dimensions		
						A	B	C
1/6	1075	208-230	Lug	CCW	3160	-	2.75	7.38
Enclosure		Speeds	FLA @ NP		Frame	Bearings	Run Cap Mfd.	
OPAO		2	1.2		39	Sleeve	4	

Replaces GE Commercial Motors by Regal-Beloit OEM model: 5KCP39HGD797S



Carrier - Model Number 5KCP39GFY917S

HP	RPM	Volts	Base	Rotation	Catalog No.	Dimensions		
						A	B	C
1/5	825	208-230	NB	CW	3S003	-	1.50	6.46
Enclosure		Speeds	FLA @ NP		Frame	Bearings	Run Cap Mfd.	
TENV		1			39	Sleeve	7.5	

Replaces GE Commercial Motors by Regal-Beloit OEM model: 5KCP39GFS166S



GE Commercial Motors

By Regal-Beloit

OEM REPLACEMENT MOTORS



Carrier - Model Number 5KCP39EGV958S

HP	RPM	Volts	Base	Rotation	Catalog No.	Dimensions		
						A	B	C
1/4	1075	230	Lug	CCW/CW	3065	-	3.00	7.46
Enclosure		Speeds	FLA @ NP		Frame	Bearings	Run Cap Mfd.	
OPAO		2	1.4		39	Sleeve	5	



Carrier - Model Number 5KCP39EGY823S

HP	RPM	Volts	Base	Rotation	Catalog No.	Dimensions		
						A	B	C
1/4	1100	208-230	Band	CW	3905	-	1.50	5.95
Enclosure		Speeds	FLA @ NP		Frame	Bearings	Run Cap Mfd.	
TEAO		1	1.4		39	Sleeve	5	

Replaces GE Commercial Motors by Regal-Beloit OEM model: 5KCP39EGS070S



Carrier - Model Number 5KCP39FGP028S

HP	RPM	Volts	Base	Rotation	Catalog No.	Dimensions		
						A	B	C
1/4	1075	230	NB	CCW	3158	-	2.75	7.21
Enclosure		Speeds	FLA @ NP		Frame	Bearings	Run Cap Mfd.	
OPAO		1	2.1		39	Sleeve	5	

Replaces GE Commercial Motors by Regal-Beloit OEM model: 5KCP39FGG262S



Carrier - Model Number 5KCP39FGY827S

HP	RPM	Volts	Base	Rotation	Catalog No.	Dimensions		
						A	B	C
1/4	1075	208-230	ECS	CCW	3910	-	3.00	7.88
Enclosure		Speeds	FLA @ NP		Frame	Bearings	Run Cap Mfd.	
OPAO		3	1.8		39	Sleeve	7.5	

Replaces GE Commercial Motors by Regal-Beloit OEM model: 5KCP39FGS075S



Carrier - Model Number 5KCP39GGY822S

HP	RPM	Volts	Base	Rotation	Catalog No.	Dimensions		
						A	B	C
1/3	1075	115	Band	CCW	3906	-	4.25	9.38
Enclosure		Speeds	FLA @ NP		Frame	Bearings	Run Cap Mfd.	
OPAO		4	5.20		39	Sleeve	5	

Replaces GE Commercial Motors by Regal-Beloit OEM model: 5KCP39GGS336S



Carrier - Model Number 5KCP39GGY826S

HP	RPM	Volts	Base	Rotation	Catalog No.	Dimensions		
						A	B	C
1/3	1100	208-230	ECS	CW	3909	-	3.00	8.13
Enclosure		Speeds	FLA @ NP		Frame	Bearings	Run Cap Mfd.	
OPAO		2	2.0		39	Sleeve	7.5	

Replaces GE Commercial Motors by Regal-Beloit OEM model: 5KCP39GGT773S



Carrier - Model Number 5KCP39HGP029S

HP	RPM	Volts	Base	Rotation	Catalog No.	Dimensions		
						A	B	C
1/3	1075	208-230	Lug	CCW	3159	-	3.00	8.13
Enclosure		Speeds	FLA @ NP		Frame	Bearings	Run Cap Mfd.	
OPAO		2	2.3		39	Sleeve	4	

Replaces GE Commercial Motors by Regal-Beloit OEM model: 5KCP39HGD797S



Carrier - Model Number 5KCP39HGP030S

HP	RPM	Volts	Base	Rotation	Catalog No.	Dimensions		
						A	B	C
1/3	1075	208-230	Lug	CCW	3161	-	3.00	8.13
Enclosure		Speeds	FLA @ NP		Frame	Bearings	Run Cap Mfd.	
OPAO		1	2.8		39	Sleeve	5	

Replaces GE Commercial Motors by Regal-Beloit OEM model: 5KCP39HG9866S



GE Commercial Motors

By Regal-Beloit

Data subject to change without notice

OEM REPLACEMENT MOTORS



Carrier - Model Number 5KCP39LGY844S

HP	RPM	Volts	Base	Rotation	Catalog No.	Dimensions		
						A	B	C
1/3	1075	230	Lug	CW	3923	-	3.00	8.25
Enclosure		Speeds	FLA @ NP		Frame	Bearings	Run Cap Mfd.	
OPAO		2	2.60		39	Sleeve	15	

Replaces GE Commercial Motors by Regal-Beloit OEM model:



Carrier - Model Number 5KCP39SGU073S

HP	RPM	Volts	Base	Rotation	Catalog No.	Dimensions		
						A	B	C
1/2	1075	200-230/460	Lug	CCW	3288	-	2.92	10.06
Enclosure		Speeds	FLA @ NP		Frame	Bearings	Run Cap Mfd.	
OPAO		1	4.6/2.3		39	Ball	7.5	

Replaces GE Commercial Motors by Regal-Beloit OEM model: 5KCP39SGL288S



Carrier - Model Number 5KCP39MGP041S

HP	RPM	Volts	Base	Rotation	Catalog No.	Dimensions		
						A	B	C
1/2	1075	208-230	Lug	CCW	3166	2.77	7.00	15.25
Enclosure		Speeds	FLA @ NP		Frame	Bearings	Run Cap Mfd.	
OPAO		3	2.9		39	Sleeve	7.5	

Replaces GE Commercial Motors by Regal-Beloit OEM model: 5KCP39MGB284S



Carrier - Model Number 5KCP39PGC138AS

HP	RPM	Volts	Base	Rotation	Catalog No.	Dimensions		
						A	B	C
1/2	1075	208-230	NB	CCW	3132	-	3.50	10.89
Enclosure		Speeds	FLA @ NP		Frame	Bearings	Run Cap Mfd.	
OPAO		1	4.0		39	Ball	7.5	

Replaces GE Commercial Motors by Regal-Beloit OEM model: 5KCP37PG190S, 5KCP37PG361S



Carrier - Model Number 5KCP39PGU719S

HP	RPM	Volts	Base	Rotation	Catalog No.	Dimensions		
						A	B	C
1/2	1050	460	ECS	CCW/CW	3901	-	2.92	8.88
Enclosure		Speeds	FLA @ NP		Frame	Bearings	Run Cap Mfd.	
TEAO		1	0.9		39	Ball	10	

Replaces GE Commercial Motors by Regal-Beloit OEM model:



Carrier - Model Number 5KCP39SGU734S

HP	RPM	Volts	Base	Rotation	Catalog No.	Dimensions		
						A	B	C
1/2	1075	208-230/460	Lug	CCW/CW	3925	-	4.00	11.82
Enclosure		Speeds	FLA @ NP		Frame	Bearings	Run Cap Mfd.	
OPAO		1	3.6/1.8		39	Ball	7.5	

Replaces GE Commercial Motors by Regal-Beloit OEM model:



Carrier - Model Number 5KCP39NGY813S

HP	RPM	Volts	Base	Rotation	Catalog No.	Dimensions		
						A	B	C
3/4	1120	115	2RR	CCW	3902	-	6.00	12.14
Enclosure		Speeds	FLA @ NP		Frame	Bearings	Run Cap Mfd.	
OPAO		4	10.0		39	Sleeve	7.5	

Replaces GE Commercial Motors by Regal-Beloit OEM model:



Carrier/Bryant - Model Number 5KCP39JGJ997T

HP	RPM	Volts	Base	Rotation	Catalog No.	Dimensions		
						A	B	C
1/3-1/4	1075	230	Lug	CCW/CW	3066	-	3.00	8.20
Enclosure		Speeds	FLA @ NP		Frame	Bearings	Run Cap Mfd.	
OPAO		2	3.1		39	Sleeve	5	

Replaces GE Commercial Motors by Regal-Beloit OEM model: 5KCP39KGB703S



GE Commercial Motors

By Regal-Beloit

OEM REPLACEMENT MOTORS



Carrier/Day & Night – Model Number 5KCP39HGA206AS

HP	RPM	Volts	Base	Rotation	Catalog No.	Dimensions		
						A	B	C
1/3	1075	208-230	NB	CW	3123	-	3.00	7.28
Enclosure		Speeds	FLA @ NP		Frame	Bearings	Run Cap Mfd.	
OPAO		2	2.8		39	Sleeve	5	

Replaces GE Commercial Motors by Regal-Beloit OEM model: 5KCP39HG7611S



Copeland – Model Number 5KCP39GGD320S

HP	RPM	Volts	Base	Rotation	Catalog No.	Dimensions		
						A	B	C
1/4	1625	230	NB	CW	3047	-	2.50	7.63
Enclosure		Speeds	FLA @ NP		Frame	Bearings	Run Cap Mfd.	
OPAO		1	1.5		39	Sleeve	5	

Replaces GE Commercial Motors by Regal-Beloit OEM model: 5KCP39GG3537S



Copeland – Model Number 5KCP39KGB906AS

HP	RPM	Volts	Base	Rotation	Catalog No.	Dimensions		
						A	B	C
1/3	1625	230	RB	CW	3124	-	1.50	8.89
Enclosure		Speeds	FLA @ NP		Frame	Bearings	Run Cap Mfd.	
TEAO		1	3.2		39	Sleeve	4	

Replaces GE Commercial Motors by Regal-Beloit OEM model: 5KCP32KG175S, 5KCP32KG259S



Copeland – Model Number 5KCP39PGC092S

HP	RPM	Volts	Base	Rotation	Catalog No.	Dimensions		
						A	B	C
1/3	825	230	NB	CW	3005	-	3.92	9.81
Enclosure		Speeds	FLA @ NP		Frame	Bearings	Run Cap Mfd.	
OPAO		1	2.4		39	Ball	12.5	

Replaces GE Commercial Motors by Regal-Beloit OEM model: 5KCP39PG3224S, 5KCP39PG915S



Fedders - Model Number 5KCP39GK4566S

HP	RPM	Volts	Base	Rotation	Catalog No.	Dimensions		
						A	B	C
1/4	1100	230	2RR	CCW	2090	-	3.50	8.84
Enclosure		Speeds	FLA @ NP		Frame	Bearings	Run Cap Mfd.	
OPAO		1	1.6		29	Sleeve	5	

Replaces GE Commercial Motors by Regal-Beloit OEM model: Various



Friedrich - Model Number 5KCP39LGM011S

HP	RPM	Volts	Base	Rotation	Catalog No.	Dimensions		
						A	B	C
1/3	1075	230	Lug	CCW	3056	2.20	2.50	9.75
Enclosure		Speeds	FLA @ NP		Frame	Bearings	Run Cap Mfd.	
TEAO		5	1.8		39	Sleeve	5	

Replaces GE Commercial Motors by Regal-Beloit OEM model: 5KCP39KGE992S, 5KCP39LGD804S, 5KCP39LGG720S, 5KCP39LKG010T, 5KCP39MG7145S, 5KCP39MG9096T, 5KCP39MG9679S



Frigidaire/Electrolux - Model Number 5KCP29KGB137S

HP	RPM	Volts	Base	Rotation	Catalog No.	Dimensions		
						A	B	C
1/4	1300/975	208-230	TFL	CCW	2S009	2.36	2.10	10.25
Enclosure		Speeds	FLA @ NP		Frame	Bearings	Run Cap Mfd.	
TEAO		2	1.6		29	Sleeve	7.5	

Replaces GE Commercial Motors by Regal-Beloit OEM model: 5KCP29KG5556S



General Electric - Model Number 5KCP39DGK014S

HP	RPM	Volts	Base	Rotation	Catalog No.	Dimensions		
						A	B	C
1/5	1075	230	Lug	CW	3078	2.10	2.00	8.75
Enclosure		Speeds	FLA @ NP		Frame	Bearings	Run Cap Mfd.	
OPAO		4	1.5		39	Sleeve	4	

Replaces GE Commercial Motors by Regal-Beloit OEM model: 5KCP39EG5480S



GE Commercial Motors

By Regal-Beloit

Data subject to change without notice

OEM REPLACEMENT MOTORS



General Electric - Model Number 5KCP39DGK013S

HP	RPM	Volts	Base	Rotation	Catalog No.	Dimensions		
						A	B	C
1/5	1075	265	Lug	CW	3077	2.10	2.00	8.75
Enclosure		Speeds	FLA @ NP		Frame	Bearings	Run Cap Mfd.	
OPAO		3	1.3		39	Sleeve	4	

Replaces GE Commercial Motors by Regal-Beloit OEM model: 5KCP39EG5967S



Goodman - Model Number 5KCP39BGY831S

HP	RPM	Volts	Base	Rotation	Catalog No.	Dimensions		
						A	B	C
1/6	1075	208-230	ECS	CCW	3911	-	2.75	6.96
Enclosure		Speeds	FLA @ NP		Frame	Bearings	Run Cap Mfd.	
TEAO		1	1.0		39	Sleeve	5	

Replaces GE Commercial Motors by Regal-Beloit OEM model: 5KCP39BGP870S



Goodman - Model Number 5KCP29ECA321S

HP	RPM	Volts	Base	Rotation	Catalog No.	Dimensions		
						A	B	C
1/6	1075	208-230	NB	CCW	2250	-	2.50	5.73
Enclosure		Speeds	FLA @ NP		Frame	Bearings	Run Cap Mfd.	
OPAO		1	1.0		29	Ball	5	

Replaces GE Commercial Motors by Regal-Beloit OEM model: 5KCP29ECA321S



Goodman - Model Number 5KCP29ECA426S

HP	RPM	Volts	Base	Rotation	Catalog No.	Dimensions		
						A	B	C
1/6	1075	208-230	ECS	CCW	2S003	-	-	5.86
Enclosure		Speeds	FLA @ NP		Frame	Bearings	Run Cap Mfd.	
TEAO		1	1.00		29	Ball	5	

Replaces GE Commercial Motors by Regal-Beloit OEM model: 5KCP29ECA033S



Goodman - Model Number 5KCP39GGY839S

HP	RPM	Volts	Base	Rotation	Catalog No.	Dimensions		
						A	B	C
1/6	810	208-230	ECS	CCW	3915	-	2.50	7.21
Enclosure		Speeds	FLA @ NP		Frame	Bearings	Run Cap Mfd.	
TEAO		1	1.10		39	Sleeve	5	

Replaces GE Commercial Motors by Regal-Beloit OEM model: 5KCP39GGY637S



Goodman - Model Number 5KCP39BGY926S

HP	RPM	Volts	Base	Rotation	Catalog No.	Dimensions		
						A	B	C
1/6	1075	208-230	NB	CCW	3S012	-	2.75	6.96
Enclosure		Speeds	FLA @ NP		Frame	Bearings	Run Cap Mfd.	
TEAO		1	1		39	Sleeve	5	

Replaces GE Commercial Motors by Regal-Beloit OEM model: 5KCP39BGP870S



Goodman - Model Number 5KCP39CFY918S

HP	RPM	Volts	Base	Rotation	Catalog No.	Dimensions		
						A	B	C
1/12	825	208-230	NB	CW	3S004	-	2.25	6.30
Enclosure		Speeds	FLA @ NP		Frame	Bearings	Run Cap Mfd.	
TENV		1	0.60		39	Sleeve	5	

Replaces GE Commercial Motors by Regal-Beloit OEM model: 5KCP39CFS300CS



Goodman - Model Number 5KCP39JFY832S

HP	RPM	Volts	Base	Rotation	Catalog No.	Dimensions		
						A	B	C
1/4	830	208-230	ECS	CCW	3917	-	1.50	6.96
Enclosure		Speeds	FLA @ NP		Frame	Bearings	Run Cap Mfd.	
TEAO		1	1.50		39	Sleeve	5	

Replaces GE Commercial Motors by Regal-Beloit OEM model: 5KCP39JFV504S



GE Commercial Motors

By Regal-Beloit

OEM REPLACEMENT MOTORS



Goodman - Model Number 5KCP39JFY840S

HP	RPM	Volts	Base	Rotation	Catalog No.	Dimensions		
						A	B	C
1/4	830	208-230	ECS	CCW	3914	-	2.50	7.90
Enclosure		Speeds	FLA @ NP		Frame	Bearings	Run Cap Mfd.	
TEAO		1	1.5		39	Sleeve	5	

Replaces GE Commercial Motors by Regal-Beloit OEM model: 5KCP39JFY627S



Goodman - Model Number 5KCP39CGY919S

HP	RPM	Volts	Base	Rotation	Catalog No.	Dimensions		
						A	B	C
1/5	1075	208-230	NB	CCW	3S005	-	3.50	8.13
Enclosure		Speeds	FLA @ NP		Frame	Bearings	Run Cap Mfd.	
TENV		2			39	Sleeve	5	

Replaces GE Commercial Motors by Regal-Beloit OEM model: 5KCP39CGP874S



Goodman - Model Number 5KCP39DFY920S

HP	RPM	Volts	Base	Rotation	Catalog No.	Dimensions		
						A	B	C
1/15	850	208-230	Lug	CW	3S006	3.00	3.25	10.30
Enclosure		Speeds	FLA @ NP		Frame	Bearings	Run Cap Mfd.	
TEAO		2	0.37		39	Sleeve	5	

Replaces GE Commercial Motors by Regal-Beloit OEM model: 5KCP39DFT606AS



Goodman - Model Number 5KCP39HGY842S

HP	RPM	Volts	Base	Rotation	Catalog No.	Dimensions		
						A	B	C
1/3	910	208-230	TFL	CCW	3916	-	4.00	9.13
Enclosure		Speeds	FLA @ NP		Frame	Bearings	Run Cap Mfd.	
OPAO		1	3.0		39	Sleeve	10	

Replaces GE Commercial Motors by Regal-Beloit OEM model: 5KCP39HGS518DS



Goodman - Model Number 5KCP39FFY921S

HP	RPM	Volts	Base	Rotation	Catalog No.	Dimensions		
						A	B	C
1/3	1075	208-230	TFL	CCW	3S007	-	3.50	8.63
Enclosure		Speeds	FLA @ NP		Frame	Bearings	Run Cap Mfd.	
OPAO		2	2.3		48	Sleeve	7.5	

Replaces GE Commercial Motors by Regal-Beloit OEM model: 5KCP39FFS396S



Goodman - Model Number 5KCP39FGY922S

HP	RPM	Volts	Base	Rotation	Catalog No.	Dimensions		
						A	B	C
1/3	1050	115	TFL	CCW	3S008	-	3.50	8.38
Enclosure		Speeds	FLA @ NP		Frame	Bearings	Run Cap Mfd.	
OPAO		3	5.1		39	Sleeve	12.5	

Replaces GE Commercial Motors by Regal-Beloit OEM model: 5KCP39FGV064AS



Goodman - Model Number 5KCP39GGY833S

HP	RPM	Volts	Base	Rotation	Catalog No.	Dimensions		
						A	B	C
1/3	1075	115	TFL	CCW	3912	-	4.00	8.3
Enclosure		Speeds	FLA @ NP		Frame	Bearings	Run Cap Mfd.	
OPAO		4	5.3		39	Sleeve	12.5	

Replaces GE Commercial Motors by Regal-Beloit OEM model: 5KCP39GGY022AS



Goodman - Model Number 5KCP39GGY923S

HP	RPM	Volts	Base	Rotation	Catalog No.	Dimensions		
						A	B	C
1/3	1075	208-230	TFL	CCW	3S009	-	3.50	8.63
Enclosure		Speeds	FLA @ NP		Frame	Bearings	Run Cap Mfd.	
OPAO		2	2.3		39	Sleeve	7.5	

Replaces GE Commercial Motors by Regal-Beloit OEM model: 5KCP39GGP993AS



GE Commercial Motors

By Regal-Beloit

Data subject to change without notice

OEM REPLACEMENT MOTORS



Goodman - Model Number 5KCP39KGY924S									
HP	RPM	Volts	Base	Rotation	Catalog No.	Dimensions			
						A	B	C	
1/2	1075	208-230	TFL	CCW	3S010	-	3.00	8.63	
Enclosure		Speeds	FLA @ NP		Frame	Bearings	Run Cap Mfd.		
OPAO		2	2.7		39	Sleeve	12.5		

Replaces GE Commercial Motors by Regal-Beloit OEM model: 5KCP39KGR696S



Goodman - Model Number 5KCP39KGY925S									
HP	RPM	Volts	Base	Rotation	Catalog No.	Dimensions			
						A	B	C	
1/2	1075	115	TFL	CCW	3S011	-	3.75	9.63	
Enclosure		Speeds	FLA @ NP		Frame	Bearings	Run Cap Mfd.		
OPAO		3	7.8		39	Sleeve	10		

Replaces GE Commercial Motors by Regal-Beloit OEM model: 5KCP39KGT785S



Goodman - Model Number 5KCP39NGY835S									
HP	RPM	Volts	Base	Rotation	Catalog No.	Dimensions			
						A	B	C	
1/2	1130	115	TFL	CCW	3913	-	4.00	9.3	
Enclosure		Speeds	FLA @ NP		Frame	Bearings	Run Cap Mfd.		
OPAO		4	8.8		39	Sleeve	20		

Replaces GE Commercial Motors by Regal-Beloit OEM model: 5KCP39NGV995AS



Heil Quaker - Model Number 5KCP29DG8965S									
HP	RPM	Volts	Base	Rotation	Catalog No.	Dimensions			
						A	B	C	
1/6	1100	208-230	ECS	CCW/CW	2957	-	2.25	6.13	
Enclosure		Speeds	FLA @ NP		Frame	Bearings	Run Cap Mfd.		
TEAO		1	1.0		29	Ball	5		



Hill Refrigeration - Model Number 5KCP39KG1369BS									
HP	RPM	Volts	Base	Rotation	Catalog No.	Dimensions			
						A	B	C	
1/3	1625	208-230	RB	CW	3001	-	3.50	9.14	
Enclosure		Speeds	FLA @ NP		Frame	Bearings	Run Cap Mfd.		
OPAO		1	2.9		39	Sleeve	5		

Replaces GE Commercial Motors by Regal-Beloit OEM model: 5KCP39KG1369S



Hill Refrigeration - Model Number - 5KCP39PGC910S									
HP	RPM	Volts	Base	Rotation	Catalog No.	Dimensions			
						A	B	C	
1	1075	208/230	RB	CCW	3067	-	3.25	9.40	
Enclosure		Speeds	FLA @ NP		Frame	Bearings	Run Cap Mfd.		
OPAO		2	7.1/6.4		39	Ball	15		

Replaces GE Commercial Motors by Regal-Beloit OEM model: 5KCP39PGC030S, 5KCP39PGC910S



Hussman - Model Number 5KCP39GG5606S									
HP	RPM	Volts	Base	Rotation	Catalog No.	Dimensions			
						A	B	C	
1/5	1075	208-230	NB	CW	3012	-	2.50	7.38	
Enclosure		Speeds	FLA @ NP		Frame	Bearings	Run Cap Mfd.		
OPAO		1	1.7		39	Sleeve	4		

Replaces GE Commercial Motors by Regal-Beloit OEM model: 5KCP39GG5606S



Hussman - Model Number 5KCP39DGY705S									
HP	RPM	Volts	Base	Rotation	Catalog No.	Dimensions			
						A	B	C	
1/6	1550	208-230	ECS	CW	3058	-	2.00	6.88	
Enclosure		Speeds	FLA @ NP		Frame	Bearings	Run Cap Mfd.		
OPAO		1	0.5		39	Sleeve	5		



GE Commercial Motors

By Regal-Beloit

OEM REPLACEMENT MOTORS



Hussman - Model Number 5KCP39GG3611S

HP	RPM	Volts	Base	Rotation	Catalog No.	Dimensions		
						A	B	C
1/5	1075	230	RB	CW	3009	-	2.50	7.39
Enclosure		Speeds	FLA @ NP		Frame	Bearings	Run Cap Mfd.	
OPAO		1	1.7		39	Sleeve	4	

Replaces GE Commercial Motors by Regal-Beloit OEM model: 5KCP39GG3611S



Hussman - Model Number 5KCP39HGU549S

HP	RPM	Volts	Base	Rotation	Catalog No.	Dimensions		
						A	B	C
1/5	1075	208-230	NB	CW	3225	-	2.50	7.63
Enclosure		Speeds	FLA @ NP		Frame	Bearings	Run Cap Mfd.	
OPAO		1	1.8		39	Ball	4	



Hussman - Model Number 5KCP39LGU550S

HP	RPM	Volts	Base	Rotation	Catalog No.	Dimensions		
						A	B	C
1/2	1725	208-230	NB	CW	3226	-	3.75	8.8
Enclosure		Speeds	FLA @ NP		Frame	Bearings	Run Cap Mfd.	
OPAO		1	2.7		39	Ball	5	



International Environmental - Model Number 5KCP29KK8983S

HP	RPM	Volts	Base	Rotation	Catalog No.	Dimensions		
						A	B	C
1/8	950	115	TFL	CCW	2S001	-	5.50	10.54
Enclosure		Speeds	FLA @ NP		Frame	Bearings	Run Cap Mfd.	
OPAO		3	3.1		29	Sleeve	10	

Replaces GE Commercial Motors by Regal-Beloit OEM model: 5KCP29KK689S



International Environmental - Model Number 5KCP29FK8997S

HP	RPM	Volts	Base	Rotation	Catalog No.	Dimensions		
						A	B	C
1/20	1075	115	TFL	CCW	2S002	-	6.50	11.04
Enclosure		Speeds	FLA @ NP		Frame	Bearings	Run Cap Mfd.	
OPAO		3	1.25		29	Sleeve	7.5	

Replaces GE Commercial Motors by Regal-Beloit OEM model: 5KCP29FK6011S



International Environmental - Model Number 5KCP29HKB023S

HP	RPM	Volts	Base	Rotation	Catalog No.	Dimensions		
						A	B	C
1/5	840	208-230	TFL	CCW	2S006	-	7.00	12.06
Enclosure		Speeds	FLA @ NP		Frame	Bearings	Run Cap Mfd.	
Open		3	1.5		29	Sleeve	6	

Replaces GE Commercial Motors by Regal-Beloit OEM model: 5KCP29HK6106S



Kramer Trenton - Model Number 5KCP39KGC100T

HP	RPM	Volts	Base	Rotation	Catalog No.	Dimensions		
						A	B	C
1/4	1075/900	115/208-230	RB	CCW	3128	-	2.00	8.14
Enclosure		Speeds	FLA @ NP		Frame	Bearings	Run Cap Mfd.	
TEAO		1	3.4/1.7		39	Ball	4	

Replaces GE Commercial Motors by Regal-Beloit OEM model: 5KCP35KG144S, 5KCP35KG554S



Lennox - Model Number 5KCP39CGP070S

HP	RPM	Volts	Base	Rotation	Catalog No.	Dimensions		
						A	B	C
1/6	1075	208-230	NB	CCW	3215	-	5.00	8.96
Enclosure		Speeds	FLA @ NP		Frame	Bearings	Run Cap Mfd.	
TEAO		1	1.0		39	Sleeve	5	

Replaces GE Commercial Motors by Regal-Beloit OEM model: 5KCP39CGM718S



GE Commercial Motors

By Regal-Beloit

OEM REPLACEMENT MOTORS



Lennox - Model Number 5KCP39HGR677S									
HP	RPM	Volts	Base	Rotation	Catalog No.	Dimensions			
A	B	C							
1/3	1075	208-230	Lug	CCW	3592	-	3.25	8.38	
Enclosure	Speeds	FLA @ NP	Frame	Bearings	Run Cap	Mfd.			
TEAO	1	2.2	39	Sleeve	5				

Replaces GE Commercial Motors by Regal-Beloit OEM model: 5KCP39HG9530S, 5KCP39HGD766T



Lennox - Model Number 5KCP39NGL571S									
HP	RPM	Volts	Base	Rotation	Catalog No.	Dimensions			
A	B	C							
1/3	825	230	2RR	CCW	3591	-	3.00	9.65	
Enclosure	Speeds	FLA @ NP	Frame	Bearings	Run Cap	Mfd.			
OPAO	1	2.5	39	Ball	4				

Replaces GE Commercial Motors by Regal-Beloit OEM model: 5KCP39NGC119S, 5KCP39NGH490T



Lennox - Model Number 5KCP39HGT584S									
HP	RPM	Volts	Base	Rotation	Catalog No.	Dimensions			
A	B	C							
1/3	1075	115	TFL	CCW	3144	-	4.00	8.28	
Enclosure	Speeds	FLA @ NP	Frame	Bearings	Run Cap	Mfd.			
OPAO	4	6.1	39	Sleeve	5				

Replaces GE Commercial Motors by Regal-Beloit OEM model: 5KCP39HGP580S



Lennox - Model Number 5KCP39HGK020S									
HP	RPM	Volts	Base	Rotation	Catalog No.	Dimensions			
A	B	C							
1/3	1075	208-230	2RR	CCW	3087	-	2.50	7.88	
Enclosure	Speeds	FLA @ NP	Frame	Bearings	Run Cap	Mfd.			
OPAO	4	2.3	39	Sleeve	5				

Replaces GE Commercial Motors by Regal-Beloit OEM model: 5KCP39HG9546S



Lennox - Model Number 5KCP39HGK018S									
HP	RPM	Volts	Base	Rotation	Catalog No.	Dimensions			
A	B	C							
1/3	1075	115	2RR	CCW	3082	-	2.50	7.89	
Enclosure	Speeds	FLA @ NP	Frame	Bearings	Run Cap	Mfd.			
OPAO	4	6.0	39	Sleeve	5				

Replaces GE Commercial Motors by Regal-Beloit OEM model: 5KCP39HG9174S



Lennox - Model Number 5KCP39PG9701S									
HP	RPM	Volts	Base	Rotation	Catalog No.	Dimensions			
A	B	C							
1/3	825	230	2RR	CCW	3050	-	3.00	9.89	
Enclosure	Speeds	FLA @ NP	Frame	Bearings	Run Cap	Mfd.			
OPAO	1	3.2	39	Sleeve	4				

Replaces GE Commercial Motors by Regal-Beloit OEM model: 5KCP39PG3490S



Lennox - Model Number 5KCP39NGT583S									
HP	RPM	Volts	Base	Rotation	Catalog No.	Dimensions			
A	B	C							
1/2	1075	115	TFL	CCW	3143	-	3.25	8.53	
Enclosure	Speeds	FLA @ NP	Frame	Bearings	Run Cap	Mfd.			
OPAO	5	8.6	39	Sleeve	7.5				

Replaces GE Commercial Motors by Regal-Beloit OEM model: 5KCP39NGR192S



Lennox - Model Number 5KCP39PGS511S									
HP	RPM	Volts	Base	Rotation	Catalog No.	Dimensions			
A	B	C							
3/4	1075	115	2RR	CCW	3275	-	2.50	8.89	
Enclosure	Speeds	FLA @ NP	Frame	Bearings	Run Cap	Mfd.			
OPAO	5	9.0	39	Sleeve	40				

Replaces GE Commercial Motors by Regal-Beloit OEM model: 5KCP39PGD852S



GE Commercial Motors

By Regal-Beloit

OEM REPLACEMENT MOTORS



Magic Chef - Model Number 5KCP29HG8964S

HP	RPM	Volts	Base	Rotation	Catalog No.	Dimensions		
						A	B	C
1/5	1075	208-230	ECS	CW	2955	-	3.71	8.34
Enclosure		Speeds	FLA @ NP	Frame	Bearings	Run Cap	Mfd.	
TEAO		1	1.6	29	Ball	5		



Nordyne - Model Number 5KCP29CCA428S

HP	RPM	Volts	Base	Rotation	Catalog No.	Dimensions		
						A	B	C
1/10	1100	208-230	NB	CW	2S005	-	1.56	4.92
Enclosure		Speeds	FLA @ NP	Frame	Bearings	Run Cap	Mfd.	
TEAO		1	0.67	29	Ball	5		

Replaces GE Commercial Motors by Regal-Beloit OEM model: 5KCP29CCA341S



Nordyne - Model Number 5KCP29FCA322S

HP	RPM	Volts	Base	Rotation	Catalog No.	Dimensions		
						A	B	C
1/8	1075	208-230	NB	CW	2251	-	2.25	5.98
Enclosure		Speeds	FLA @ NP	Frame	Bearings	Run Cap	Mfd.	
OPAO		1	1.1	29	Ball	5		

Replaces GE Commercial Motors by Regal-Beloit OEM model: 5KCP29FCA322S



Nordyne - Model Number 5KCP39HGY931S

HP	RPM	Volts	Base	Rotation	Catalog No.	Dimensions		
						A	B	C
1/3	1075	115	NB	CCW	3S017	-	4.00	8.71
Enclosure		Speeds	FLA @ NP	Frame	Bearings	Run Cap	Mfd.	
OPAO		3	6	39	Sleeve	5		

Replaces GE Commercial Motors by Regal-Beloit OEM model: 5KCP39HGR025S



Rheem - Model Number 5KCP39BGT944S

HP	RPM	Volts	Base	Rotation	Catalog No.	Dimensions		
						A	B	C
1/6	1075	208-230	NB	CCW	3222	-	3.25	7.45
Enclosure		Speeds	FLA @ NP	Frame	Bearings	Run Cap	Mfd.	
TEAO		1	0.9	39	Sleeve	3		

Replaces GE Commercial Motors by Regal-Beloit OEM model: 5KCP39BGN253S



Rheem - Model Number 5KCP39CGP088S

HP	RPM	Volts	Base	Rotation	Catalog No.	Dimensions		
						A	B	C
1/5	1075	208-230	NB	CCW	3220	-	4.00	8.21
Enclosure		Speeds	FLA @ NP	Frame	Bearings	Run Cap	Mfd.	
TEAO		1	1.0	39	Sleeve	3		

Replaces GE Commercial Motors by Regal-Beloit OEM model: 5KCP39CGK082S, 5KCP39CGN126S, 5KCP39CGN409S



Rheem - Model Number 5KCP39FGP087S

HP	RPM	Volts	Base	Rotation	Catalog No.	Dimensions		
						A	B	C
1/3	1075	208-230	NB	CCW	3221	-	4.00	8.46
Enclosure		Speeds	FLA @ NP	Frame	Bearings	Run Cap	Mfd.	
TEAO		1	2.0	39	Sleeve	5		

Replaces GE Commercial Motors by Regal-Beloit OEM model: 5KCP39FGK074S, 5KCP39FGN223S, 5KCP39FGN407S



Rheem - Model Number 5KCP39GGY929S

HP	RPM	Volts	Base	Rotation	Catalog No.	Dimensions		
						A	B	C
1/3	1075	208-230	NB	CCW	3S015	-	2.00	6.55
Enclosure		Speeds	FLA @ NP	Frame	Bearings	Run Cap	Mfd.	
TEAO		1	1.5	39	Sleeve	5		

Replaces GE Commercial Motors by Regal-Beloit OEM model: 5KCP29GGS325S



GE Commercial Motors

By Regal-Beloit

Data subject to change without notice

OEM REPLACEMENT MOTORS



Rheem - Model Number 5KCP39NGY930S									
HP	RPM	Volts	Base	Rotation	Catalog No.	Dimensions			
A	B	C							
1/3	900	208/230	NB	CCW	3S016	-	2.00	7.30	
Enclosure		Speeds	FLA @ NP		Frame	Bearings	Run Cap Mfd.		
Dripproof		2	3.2		39	Sleeve	15		

Replaces GE Commercial Motors by Regal-Beloit OEM model: 5KCP39NGV413AS



Rheem - Model Number 5KCP39RGY787S									
HP	RPM	Volts	Base	Rotation	Catalog No.	Dimensions			
A	B	C							
3/4-1/4	1075	115	Band	CCW/CW	3903	-	6.00	11.81	
Enclosure		Speeds	FLA @ NP		Frame	Bearings	Run Cap Mfd.		
OPAO		4	11.50		39	Sleeve	15		



Rheem/Ruud - Model Number 5KCP39GGN333S									
HP	RPM	Volts	Base	Rotation	Catalog No.	Dimensions			
A	B	C							
1/8	825	208-230	NB	CCW	3155	-	3.75	8.45	
Enclosure		Speeds	FLA @ NP		Frame	Bearings	Run Cap Mfd.		
TEAO		1	1.2		39	Sleeve	5		

Replaces GE Commercial Motors by Regal-Beloit OEM model: 5KCP39GGD121S, 5KCP39GGK789S



Rheem/Ruud - Model Number 5KCP39CGN330S									
HP	RPM	Volts	Base	Rotation	Catalog No.	Dimensions			
A	B	C							
1/5	1075	208-230	NB	CCW	3153	-	3.75	7.96	
Enclosure		Speeds	FLA @ NP		Frame	Bearings	Run Cap Mfd.		
TEAO		1	1.7		39	Sleeve	3		

Replaces GE Commercial Motors by Regal-Beloit OEM model: 5KCP39CGE717S, 5KCP39CGK787S



Rheem/Ruud - Model Number 5KCP39FGN329S									
HP	RPM	Volts	Base	Rotation	Catalog No.	Dimensions			
A	B	C							
1/3	1075	208-230	NB	CCW	3154	-	3.75	8.21	
Enclosure		Speeds	FLA @ NP		Frame	Bearings	Run Cap Mfd.		
TEAO		1	1.8		39	Sleeve	5		

Replaces GE Commercial Motors by Regal-Beloit OEM model: 5KCP39FGK786S, 5KCP39GGE879S



Rheem/Ruud - Model Number 5KCP39GGY845S									
HP	RPM	Volts	Base	Rotation	Catalog No.	Dimensions			
A	B	C							
1/3	1075	208-230	ECS	CCW/CW	3924	-	3.75	8.06	
Enclosure		Speeds	FLA @ NP		Frame	Bearings	Run Cap Mfd.		
TEAO		1	1.8		39	Sleeve	5		

Sears/Whirlpool - Model Number 5KCP39GGB158S



HP	RPM	Volts	Base	Rotation	Catalog No.	Dimensions			
A	B	C							
1/3	1075	208-230	NB	CCW	3070	5.20	4.75	14.00	
Enclosure		Speeds	FLA @ NP		Frame	Bearings	Run Cap Mfd.		
OPAO		3	1.9		39	Sleeve	5		

Replaces GE Commercial Motors by Regal-Beloit OEM model: 5KCP39GGA332S



Snyder/Arco - Model Number 5KCP39DGP089S									
HP	RPM	Volts	Base	Rotation	Catalog No.	Dimensions			
A	B	C							
1/10	825	208-230	NB	CCW	3219	-	3.00	6.78	
Enclosure		Speeds	FLA @ NP		Frame	Bearings	Run Cap Mfd.		
TEAO		1	0.7		39	Sleeve	5		

Replaces GE Commercial Motors by Regal-Beloit OEM model: 5KCP39DGK093S



GE Commercial Motors

By Regal-Beloit

OEM REPLACEMENT MOTORS



Trane - Model Number 5KCP39SGY830S

HP	RPM	Volts	Base	Rotation	Catalog No.	Dimensions		
A	B	C						
0.6	975	208-230	ECS	CCW	3922	-	3.50	10.38
Enclosure		Speeds	FLA @ NP	Frame	Bearings	Run Cap	Mfd.	
TEAO		1	3.80	39	Sleeve	7.5		

Replaces GE Commercial Motors by Regal-Beloit OEM model: 5KCP39SGR077S



Trane - Model Number 5KCP39RFY828S

HP	RPM	Volts	Base	Rotation	Catalog No.	Dimensions		
A	B	C						
0.4	1075	380-415/460	ECS	CCW	3920	-	3.50	10.38
Enclosure		Speeds	FLA @ NP	Frame	Bearings	Run Cap	Mfd.	
TEAO		1	1.4	39	Sleeve	5		

Replaces GE Commercial Motors by Regal-Beloit OEM model: 5KCP39RFR809S



Trane - Model Number 5KCP29BK8219S

HP	RPM	Volts	Base	Rotation	Catalog No.	Dimensions		
A	B	C						
1/8	1650	200-230	NB	CCW	2743	-	2.00	6.09
Enclosure		Speeds	FLA @ NP	Frame	Bearings	Run Cap	Mfd.	
TEAO		1	0.8	29	Sleeve	4		

Replaces GE Commercial Motors by Regal-Beloit OEM model: 5KCP29BK6319S



Trane - Model Number 5KCP39BGY814S

HP	RPM	Volts	Base	Rotation	Catalog No.	Dimensions		
A	B	C						
1/8	1650	230	ECS	CW	3904	-	2.00	6.06
Enclosure		Speeds	FLA @ NP	Frame	Bearings	Run Cap	Mfd.	
TEAO		1	0.80	29	Sleeve	4		



Trane - Model Number 5KCP29BCA427S

HP	RPM	Volts	Base	Rotation	Catalog No.	Dimensions		
A	B	C						
1/6	1625	208-230	NB	CCW	2S004	-	2.00	5.36
Enclosure		Speeds	FLA @ NP	Frame	Bearings	Run Cap	Mfd.	
TEAO		1	0.98	42	Ball	4		

Replaces GE Commercial Motors by Regal-Beloit OEM model: 5KCP29BCA010AS



Trane - Model Number 5KCP39FFY927S

HP	RPM	Volts	Base	Rotation	Catalog No.	Dimensions		
A	B	C						
1/5	1080	208-230	NB	CCW	3S013	-	2.50	8.13
Enclosure		Speeds	FLA @ NP	Frame	Bearings	Run Cap	Mfd.	
TEAO		1	1.6	39	Sleeve	5		

Replaces GE Commercial Motors by Regal-Beloit OEM model: 5KCP39FFP576AS



Trane - Model Number 5KCP39LGY928S

HP	RPM	Volts	Base	Rotation	Catalog No.	Dimensions		
A	B	C						
1/2	1075	115	NB	CCW	3S014	-	4.00	9.88
Enclosure		Speeds	FLA @ NP	Frame	Bearings	Run Cap	Mfd.	
OPAO		4	7.9	39	Sleeve	10		

Replaces GE Commercial Motors by Regal-Beloit OEM model: 5KCP39LGP918AS



Trane - Model Number 5KCP39KGY834S

HP	RPM	Volts	Base	Rotation	Catalog No.	Dimensions		
A	B	C						
1/2	1375	115	ECS	CCW	3918	-	2.50	8.13
Enclosure		Speeds	FLA @ NP	Frame	Bearings	Run Cap	Mfd.	
OPAO		4	9.3	39	Sleeve	15		

Replaces GE Commercial Motors by Regal-Beloit OEM model: 5KCP39KGN691AS



GE Commercial Motors

By Regal-Beloit

OEM REPLACEMENT MOTORS



Trane - Model Number 5KCP39PFY829S

HP	RPM	Volts	Base	Rotation	Catalog No.	Dimensions		
						A	B	C
1/2	850	208-230	ECS	CW	3919	-	4.00	10.88
Enclosure		Speeds	FLA @ NP	Frame	Bearings	Run Cap Mfd.		
OPAO		2	3.40	39	Sleeve	10		

Replaces GE Commercial Motors by Regal-Beloit OEM model: 5KCP39PFR083S



Trane - Model Number 5KCP39SFU729S

HP	RPM	Volts	Base	Rotation	Catalog No.	Dimensions		
						A	B	C
1	1125	575	ECS	CCW	3921	-	3.42	9.72
Enclosure		Speeds	FLA @ NP	Frame	Bearings	Run Cap Mfd.		
TEAO		1	2.0	39	Ball	25		

Replaces GE Commercial Motors by Regal-Beloit OEM model: 5KCP39SFL190CS



Various OEMs - Model Number 5KCP29CK4534S

HP	RPM	Volts	Base	Rotation	Catalog No.	Dimensions		
						A	B	C
1/10	1075	115	RB	CW	2362	9.58	10.50	25.00
Enclosure		Speeds	FLA @ NP	Frame	Bearings	Run Cap Mfd.		
OPAO		4	1.7	29	Sleeve	4		

Replaces GE Commercial Motors by Regal-Beloit OEM model: 5KCP29CK4534T

Various OEMs - Model Number 5KCP29BG6688S

HP	RPM	Volts	Base	Rotation	Catalog No.	Dimensions		
						A	B	C
1/30	1075	208	ECS	CCW/CW	2S007	-	6.55	10.18
Enclosure		Speeds	FLA @ NP	Frame	Bearings	Run Cap Mfd.		
TEAO		3	0.4	29	Ball	5		

Westinghouse - Model Number 5KCP39GGB907S



HP	RPM	Volts	Base	Rotation	Catalog No.	Dimensions		
						A	B	C
1/3	1625/1350	208-240/220	RB	CCW	3122	6.60	6.00	19.50
Enclosure		Speeds	FLA @ NP	Frame	Bearings	Run Cap Mfd.		
OPAO		1	2.5	39	Sleeve	5		

Replaces GE Commercial Motors by Regal-Beloit OEM model: 5KCP32GG167S, 5KCP32GG210S, 5KCP32GG258S



York - Model Number 5KCP39BGY932S

HP	RPM	Volts	Base	Rotation	Catalog No.	Dimensions		
						A	B	C
1/8	1075	208-230	NB	CW	3S018	-	1.25	5.46
Enclosure		Speeds	FLA @ NP	Frame	Bearings	Run Cap Mfd.		
TEAO		1	0.8	39	Sleeve	4		

Replaces GE Commercial Motors by Regal-Beloit OEM model: 5KCP39BGP931S



York - Model Number 5KCP39EGY933S

HP	RPM	Volts	Base	Rotation	Catalog No.	Dimensions		
						A	B	C
1/4	1075	208-230	NB	CW	3S019	-	2.50	6.96
Enclosure		Speeds	FLA @ NP	Frame	Bearings	Run Cap Mfd.		
TEAO		1	1.3	39	Sleeve	5		

Replaces GE Commercial Motors by Regal-Beloit OEM model: 5KCP39EGP788S



GE Commercial Motors

By Regal-Beloit

OEM REPLACEMENT MOTORS



York - Model Number 5KCP29GK8218S									
HP	RPM	Volts	Base	Rotation	Catalog No.	Dimensions			
						A	B	C	
1/5	1075	208-230	NB	CW	2746	5.57	5.75	16.49	
Enclosure		Speeds	FLA @ NP		Frame	Bearings	Run Cap Mfd.		
TEAO		1	1.1		29	Sleeve	5		

Replaces GE Commercial Motors by Regal-Beloit OEM model: 5KCP29GK3643S



York - Model Number 5KCP29GK8966S									
HP	RPM	Volts	Base	Rotation	Catalog No.	Dimensions			
						A	B	C	
1/5	1075	208-230	Band	CW	2956	5.63	5.63	16.42	
Enclosure		Speeds	FLA @ NP		Frame	Bearings	Run Cap Mfd.		
OPAO		1	1.2		29	Sleeve	5		



York - Model Number 5KCP39JFY934S									
HP	RPM	Volts	Base	Rotation	Catalog No.	Dimensions			
						A	B	C	
1/4	850	208-230	NB	CW	3S020	-	2.75	7.96	
Enclosure		Speeds	FLA @ NP		Frame	Bearings	Run Cap Mfd.		
OPAO		1	1.3		39	Sleeve	5		

Replaces GE Commercial Motors by Regal-Beloit OEM model: 5KCP39JFP984S



York - Model Number 5KCP39LGY935S									
HP	RPM	Volts	Base	Rotation	Catalog No.	Dimensions			
						A	B	C	
1/2	1090	208-230	NB	CW	3S021	-	3.50	8.96	
Enclosure		Speeds	FLA @ NP		Frame	Bearings	Run Cap Mfd.		
TEAO		1	2.3		39	Sleeve	7.5		

Replaces GE Commercial Motors by Regal-Beloit OEM model: 5KCP39LGN418S



York - Model Number 5KCP39NGY936S									
HP	RPM	Volts	Base	Rotation	Catalog No.	Dimensions			
						A	B	C	
1/2	1110	115	NB	CCW	3S022	-	4.00	10.13	
Enclosure		Speeds	FLA @ NP		Frame	Bearings	Run Cap Mfd.		
OPAO		3	9.5		39	Sleeve	10		

Replaces GE Commercial Motors by Regal-Beloit OEM model: 5KCP39NGP941S



York/Borg Warner - Model Number 5KCP29GK4685S									
HP	RPM	Volts	Base	Rotation	Catalog No.	Dimensions			
						A	B	C	
1/5	1075	230	NB	CW	2091	5.93	5.92	16.75	
Enclosure		Speeds	FLA @ NP		Frame	Bearings	Run Cap Mfd.		
OPAO		1	1.4		29	Sleeve	5		

Replaces GE Commercial Motors by Regal-Beloit OEM model: Various



GE Commercial Motors

By Regal-Beloit



Features

- RoHS Compliant
- 10,000 Hr Life Reliability
- Meets IEC - 252 Class B Reliability Standard
- Patented Pressure Sensitive Interrupter (PSI)

Applications

- Heating and Cooling Equipment
- Appliances
- Business Machines
- Office Equipment
- Light Commercial and Industrial Equipment



PROLINE™ - Oval - 240 Volt AC

Cat. No.	Base Size	Case Height	uF 1	uF 2	Op. Temp.	Base Code	Box Qty
PB300E000C240CAS	1.75	2.88	30.0	-	-40°C to 70°C	C	24
PB350E000C240DAS	1.75	3.88	35.0	-	-40°C to 70°C	C	24

PROLINE™ - Oval - 370 Volt AC

PB050E000A370AAS	1.25	1.56	5.0	-	-40°C to 70°C	A	48
PB060E000A370BAS	1.25	2.12	6.0	-	-40°C to 70°C	A	48
PB075E000A370BAS	1.25	2.12	7.5	-	-40°C to 70°C	A	48
PB100E000A370CAS	1.25	2.88	10.0	-	-40°C to 70°C	A	48
PB125E000A370CAS	1.25	2.88	12.5	-	-40°C to 70°C	A	48
PB150E000A370CAS	1.25	2.88	15.0	-	-40°C to 70°C	A	48
PB175E000A370DAS	1.25	3.88	17.5	-	-40°C to 70°C	A	48
PB200E000A370DAS	1.25	3.88	20.0	-	-40°C to 70°C	A	48
PB250E000A370DAS	1.25	3.88	25.0	-	-40°C to 70°C	A	48
PB300E000A370EAS	1.25	4.75	30.0	-	-40°C to 70°C	A	48
PB350E000A370EAS	1.25	4.75	35.0	-	-40°C to 70°C	A	48
PB400E000C370DAS	1.75	3.88	40.0	-	-40°C to 70°C	C	24
PB450E000C370DAS	1.75	3.88	45.0	-	-40°C to 70°C	C	24
PB500E000C370DAS	1.75	3.88	50.0	-	-40°C to 70°C	C	24

PROLINE™ - Oval - 440 Volt AC

PB030E000A440AAS	1.25	1.56	3.0	-	-40°C to 70°C	A	48
PB040E000A440AAS	1.25	1.56	4.0	-	-40°C to 70°C	A	48
PB050E000A440BAS	1.25	2.12	5.0	-	-40°C to 70°C	A	48
PB060E000A440BAS	1.25	2.12	6.0	-	-40°C to 70°C	A	48
PB075E000A440CAS	1.25	2.88	7.5	-	-40°C to 70°C	A	48
PB100E000A440CAS	1.25	2.88	10.0	-	-40°C to 70°C	A	48
PB125E000A440DAS	1.25	3.88	12.5	-	-40°C to 70°C	A	48
PB150E000A440EAS	1.25	4.75	15.0	-	-40°C to 70°C	A	48
PB200E000A440EAS	1.25	4.75	20.0	-	-40°C to 70°C	A	48
PB250E000A440EAS	1.25	4.75	25.0	-	-40°C to 70°C	A	48
PB300E000C440DAS	1.75	3.88	30.0	-	-40°C to 70°C	C	24
PB350E000C440DAS	1.75	3.88	35.0	-	-40°C to 70°C	C	24
PB400E000C440DAS	1.75	3.88	40.0	-	-40°C to 70°C	C	24
PB450E000C440EAS	1.75	4.75	45.0	-	-40°C to 70°C	C	24
PB550E000D440EAS	2.00	4.75	55.0	-	-40°C to 70°C	D	20
PB600E000D440HAS	2.00	4.25	60.0	-	-40°C to 70°C	D	20

CAPACITORS
PROLINE™ CAPACITORS



Features

- RoHS Compliant
- 10,000 Hr Life Reliability
- Meets IEC - 252 Class B Reliability Standard
- Patented Pressure Sensitive Interrupter (PSI)

Applications

- Heating and Cooling Equipment
- Appliances
- Business Machines
- Office Equipment
- Light Commercial and Industrial Equipment



PROLINE™ - Round - 440 Volt AC

Cat. No.	Base Size	Case Height	uF 1	uF 2	Op. Temp.	Base Code	Box Qty
PB125E000P440CAS	1.75	2.88	12.5	-	-40°C to 70°C	P	45
PB150E000P440CAS	1.75	2.88	15.0	-	-40°C to 70°C	P	45
PB200E000P440CAS	1.75	2.88	20.0	-	-40°C to 70°C	P	45
PB250E000P440DAS	1.75	3.88	25.0	-	-40°C to 70°C	P	45
PB300E000P440DAS	1.75	3.88	30.0	-	-40°C to 70°C	P	45
PB250Z050S440DAS	2.00	3.88	25.0	5.0	-40°C to 70°C	S	32
PB350Z050S440EAS	2.00	4.75	35.0	5.0	-40°C to 70°C	S	32
PB450Z050T440DAS	2.50	3.88	45.0	5.0	-40°C to 70°C	T	18
PB550Z075T440EAS	2.50	4.75	55.0	7.5	-40°C to 70°C	T	18

CAPACITORS
GENTEQ™ CAPACITORS



Features

- RoHS Compliant
- 60,000 Hr Life Reliability
- Meets EIA-456 Reliability Standard
- Patented Pressure Sensitive Interrupter (PSI)

Applications

- Heating and Cooling Equipment
- Appliances
- Business Machines
- Office Equipment
- Light Commercial and Industrial Equipment



Oval - 280 Volt AC

Cat. No.	Base Size	Case Height	uF 1	uF 2	Op. Temp.	Base Code	Box Qty
97F6823S	1.75	2.88	28.0	-	-40°C to 70°C	C	24
97F6836S	1.75	3.88	48.0	-	-40°C to 70°C	C	24

Oval - 330 Volt AC

97F6749S	1.50	2.88	13.5	-	-40°C to 70°C	B	30
97F6755S	1.50	3.88	26.0	-	-40°C to 70°C	B	30
97F6759S	1.50	3.88	24.0	-	-40°C to 70°C	B	30
97F6763S	1.25	3.88	10.0	-	-40°C to 70°C	A	48
97F6766S	1.25	2.88	7.0	-	-40°C to 70°C	A	48

Oval - 370 Volt AC

27L566S	1.25	2.12	7.5	-	-40°C to 70°C	A	48
27L567S	1.25	2.88	15.0	-	-40°C to 70°C	A	48
27L570S	1.25	1.56	5.0	-	-40°C to 70°C	A	48
27L572S	1.25	2.88	12.5	-	-40°C to 70°C	A	48
97F5706S	1.25	2.12	6.0	-	-40°C to 70°C	A	48
97F8054S	1.25	2.12	3.0	-	-40°C to 90°C	A	48
97F8055S	1.25	2.12	4.0	-	-40°C to 90°C	A	48
97F8056S	1.25	2.88	5.0	-	-40°C to 90°C	A	48
97F8057S	1.25	2.88	6.0	-	-40°C to 90°C	A	48
97F8058S	1.25	2.88	7.5	-	-40°C to 90°C	A	48
97F8059S	1.25	3.88	10.0	-	-40°C to 90°C	A	48
97F8060S	1.25	3.88	12.5	-	-40°C to 90°C	A	48
97F9002S	1.25	2.88	10.0	-	-40°C to 70°C	A	48

Oval - 440 Volt AC

27L1022S	1.25	1.56	3.0	-	-40°C to 70°C	A	48
27L1023S	1.25	1.56	4.0	-	-40°C to 70°C	A	48
27L1024S	1.25	2.12	5.0	-	-40°C to 70°C	A	48
27L1025S	1.25	2.12	6.0	-	-40°C to 70°C	A	48
27L1027S	1.25	2.88	10.0	-	-40°C to 70°C	A	48
27L695S	1.25	2.88	7.5	-	-40°C to 70°C	A	48
97F5388S	1.25	3.88	12.5	-	-40°C to 70°C	A	48
97F9625S	1.25	4.75	15.0	-	-40°C to 70°C	A	48
97F9638S	1.75	3.88	35.0	-	-40°C to 70°C	C	24



Features

- RoHS Compliant
- 60,000 Hr Life Reliability
- Meets EIA-456 Reliability Standard
- Patented Pressure Sensitive Interrupter (PSI)

Applications

- Heating and Cooling Equipment
- Appliances
- Business Machines
- Office Equipment
- Light Commercial and Industrial Equipment



Round - 240 Volt AC

Cat. No.	Base Size	Case Height	uF 1	uF 2	Op. Temp.	Base Code	Box Qty
97F8036S	1.75	2.88	15.0	-	-40°C to 90°C	P	45
97F8037S	1.75	2.88	25.0	-	-40°C to 90°C	P	45
97F8038S	1.75	3.88	30.0	-	-40°C to 90°C	P	45
97F8039S	1.75	3.88	35.0	-	-40°C to 90°C	P	45
97F8040S	1.75	3.88	40.0	-	-40°C to 90°C	P	45
97F8042S	1.75	4.75	50.0	-	-40°C to 90°C	P	45
97F8044S	2.00	4.75	60.0	-	-40°C to 90°C	S	32
97F8049S	2.50	3.88	85.0	-	-40°C to 90°C	T	18
97F8050S	2.50	3.88	90.0	-	-40°C to 90°C	T	18
97F8052S	2.50	4.75	100.0	-	-40°C to 90°C	T	18
97F8053S	2.50	4.75	120.0	-	-40°C to 90°C	T	18

Round - 370 Volt AC

97F8061S	1.75	2.88	15.0	-	-40°C to 90°C	P	45
97F8063S	1.75	3.88	20.0	-	-40°C to 90°C	P	45
97F8064S	1.75	3.88	25.0	-	-40°C to 90°C	P	45
97F8065S	1.75	3.88	30.0	-	-40°C to 90°C	P	45
97F8066S	1.75	4.75	35.0	-	-40°C to 90°C	P	45
97F8067S	1.75	4.75	40.0	-	-40°C to 90°C	P	45
97F9602S	1.75	2.88	20.0	-	-40°C to 70°C	P	45
97F9606S	1.75	2.88	25.0	-	-40°C to 70°C	P	45
97F9608S	1.75	3.88	30.0	-	-40°C to 70°C	P	45
97F9614S	1.75	3.88	40.0	-	-40°C to 70°C	P	45
97F9802S	1.75	4.75	50.0	-	-40°C to 70°C	P	45
97F9884S	1.75	4.75	45.0	-	-40°C to 70°C	P	45
27L877S	2.00	2.88	30.0	5.0	-40°C to 70°C	S	32
27L880S	2.00	3.88	45.0	5.0	-40°C to 70°C	S	32
97F8068S	2.00	4.75	45.0	-	-40°C to 90°C	S	32
97F8069S	2.00	4.75	50.0	-	-40°C to 90°C	S	32
97F8070S	2.00	4.75	55.0	-	-40°C to 90°C	S	32
97F9010S	2.00	4.75	55.0	-	-40°C to 70°C	S	32
97F9613S	2.00	2.88	35.0	-	-40°C to 70°C	S	32
97F9834S	2.00	3.88	35.0	5.0	-40°C to 70°C	S	32
97F9849S	2.00	3.88	40.0	5.0	-40°C to 70°C	S	32
97F9970S	2.00	4.75	50.0	5.0	-40°C to 70°C	S	32
97F5276S	2.50	3.88	60.0	-	-40°C to 70°C	T	18
97F8071S	2.50	3.88	60.0	-	-40°C to 90°C	T	18
97F8072S	2.50	3.88	65.0	-	-40°C to 90°C	T	18
97F8073S	2.50	4.75	70.0	-	-40°C to 90°C	T	18
97F9011S	2.50	3.88	65.0	-	-40°C to 70°C	T	18
97F9012S	2.50	4.75	70.0	-	-40°C to 70°C	T	18
97F9815S	2.50	3.88	55.0	5.0	-40°C to 70°C	T	18

Round - 440 Volt AC

97F5001S	1.75	2.88	12.5	-	-40°C to 70°C	P	45
97F9626S	1.75	2.88	15.0	-	-40°C to 70°C	P	45
97F9632S	1.75	3.88	25.0	-	-40°C to 70°C	P	45
97F9635S	1.75	3.88	30.0	-	-40°C to 70°C	P	45
97F9978S	2.00	3.88	25.0	-	-40°C to 70°C	S	32
97F9848S	2.00	4.75	35.0	5.0	-40°C to 70°C	S	32
97F9851S	2.50	3.88	45.0	5.0	-40°C to 70°C	T	18
97F9874S	2.50	4.75	55.0	7.5	-40°C to 70°C	T	18

KITS & ACCESSORIES

Capacitor Kit



For Type KCP models. Kit contains a capacitor, mounting strap, rubber pad, rubber terminal cover, mounting screws, ground wire, and safety instructions.

Capacitor Rating	Multiplier Symbol	Catalog Number
3mfd/370V	RB3KITS	A485
4mfd/370V	RB3KITS	A486
5mfd/370V	RB3KITS	A487
7.5mfd/370V	RB3KITS	A488
10mfd/370V	RB3KITS	A489
15mfd/370V	RB3KITS	A490

Note: Intended for 5.0" diameter, GE 29 Frame motors

Resilient Base



3-1/2" centerline height. For use with 2-1/2" resilient rings.

YO Dimension = Centerline of resilient ring to centerline of opposite resilient ring.

Shell Material	Shell Length	YO Dim.	Multiplier Symbol	Catalog Number
Steel	4.155"			
Aluminum	3.622"	5.12/5.00	RB3KITS	A455

Note: Intended for 5.0" diameter, GE 29 Frame motors; for other 29 Frame shell length kits please contact Regal Beloit for a quote.

Resilient Base Kit



Includes base and latch straps. For use with motors having 2-1/4" resilient rings.

Cat. #A461



Cat. #A468

3.0" Centerline Height

Shell Length	YO Dim.	Multiplier Symbol	Catalog No.
3.07	4.39	RB3KITS	A461
3.32	4.64	RB3KITS	A462
3.82	5.14	RB3KITS	A463
4.07	5.39	RB3KITS	A464
4.32	5.64	RB3KITS	A465
4.82	6.14	RB3KITS	A467
5.32	6.44	RB3KITS	A466

Note: Intended for 5.5" diameter, GE 39 Frame motors

3.5" Centerline Height

Shell Length	YO Dim.	Multiplier Symbol	Catalog No.
2.82	4.14	RB3KITS	A468
3.07	4.39	RB3KITS	A469
3.32	4.64	RB3KITS	A470
3.57	4.89	RB3KITS	A471
3.82	5.14	RB3KITS	A472
4.07	5.39	RB3KITS	A473
4.32	5.64	RB3KITS	A474
4.82	6.14	RB3KITS	A476
5.32	6.64	RB3KITS	A475

Note: Intended for 5.5" diameter, GE 39 Frame motors



GE Commercial Motors

By Regal-Beloit

KITS & ACCESSORIES

Resilient Base Latches



Cat. #A195

For use with standard bases. Two are required per motor.

Frame Size	Ring Diameter	Multiplier Symbol	Catalog No.
30 or 40	2.25	RB2KITS	A195
40	2.50	RB2KITS	A518

External Water Slinger



Cat. #A484

Provides rain protection for vertically mounted condenser motors.

Cat. #A484

Note: Intended for 5.0" diameter, GE 29 Frame motors

Description	Multiplier Symbol	Catalog Number
3-5/8" Diameter	RB3KITS	A483
6" Diameter	RB3KITS	A484

Cushion Ring



Cat. #A494

Two cushion rings will be supplied for each stock number ordered.

Note: Intended for 5.5" diameter, GE 39 Frame motors

Ring Diameter	Ring Type	Multiplier Symbol	Catalog No.
2-1/4	Bonded	RB3KITS	A494
2-1/2	Bonded	RB3KITS	A493
2-1/2	Unbonded	RB3KITS	A460

Split Ring



Two split rings are required to adapt a 2.25" ring to 2.5". Four split rings will be supplied for each stock number ordered.

Note: GE 39 Frame motors

When Used	Multiplier Symbol	Catalog No.
5-1/2" diameter motors	RB3KITS	A459



KITS & ACCESSORIES

Shaft Adapter Kit



Includes adapter and key.

Cat. #A225

Change Shaft Diameter	Multiplier Symbol	Catalog No.
From 1/2 to 5/8	RB2KITS	A224

Length Adapter Kit



For use when additional motor length is required to fit an existing application. This kit is included with many models where applicable.

Note: Intended for 5.0" diameter, GE 29 Frame motors

Description	Multiplier Symbol	Catalog Number
One Adapter	RB3KITS	A477
Two Adapters	RB3KITS	A478

Torsion Flex Mounting Adapter - 3 Lug



For mounting on both 9" and 10" blowers.

When Used	Multiplier Symbol	Catalog NO.
5" & 5-1/2" diameter motors	RB3KITS	A556



GE Commercial Motors

By Regal-Beloit

GENTEQ™ ACCESSORIES
ECM SERVICE TOOLS

GENTEQ™ TECMate Service Tool



Features

- Analyzes the Genteq motor independent of the HVAC system
- Detect and isolate motor failures from HVAC system failures
- Use the supplied ECM Service Guide diagnose the motor separate from the motor control with an ohm meter. This guide will also provide diagnostics on the X13 motor using a VOM meter
- Easy to use

Applications

Designed to diagnose GE ECM by Regal-Beloit variable speed models 2.0, 2.3, and 3.0.

NOTE: Use 16-4 pin adapter for troubleshooting the latest generation model 3.0 including connection and operation instructions. Please see www.theDealerToolbox.com for more details.

Catalog Number	Multiplier Symbol	Weight
A447	RB1EACC	1 lb.

GENTEQ™ ECM Service Guide



Features

- Pocket sized manual
- Provides important information and guidelines on how to properly diagnose, service and optimize homeowner comfort with Genteq driven systems
- Can be downloaded for free at www.theDealerToolbox.com
- Sold in packs of 10 (ordering qty, 1 of this model numbers equals 10 manuals)

Applications

Designed to help the Service Technician diagnose issues and service ECM 2.3 and X13 motors

Catalog Number	Multiplier Symbol	Weight
8794721FT	NA	2 lb.

INTRODUCING

THE MOST ECONOMICAL REPLACEMENT MOTOR EVERGREEN.



Evergreen®

www.EvergreenDealer.com
www.thedealertools.com

Perennial Savings

The blower motor is the heart of your furnace or air handler, forcing the air through your ductwork to warm or cool your home. Evergreen is the high-efficiency replacement for a standard blower motor, much like using a compact-fluorescent (CFL) replacement for a typical lightbulb. It uses proven ECM (*electronically commutated motor*) technology to save you money every time your HVAC system is operating. On average you can expect to save over 25% on annual motor operating costs. Even better, you can use up to 75% fewer Watts with Evergreen when you run your system on constant fan.

Features

- Two motors cover all applications
- Multi-volt 115/230 and Reversible Rotation
- Integrated with HVAC system controls/operation
- Four speed selections for heating and cooling
- Optimized constant fan speed
- Two (2) year warranty
- Reduce truck stock, no capacitors to change out or stock
- Soft Start

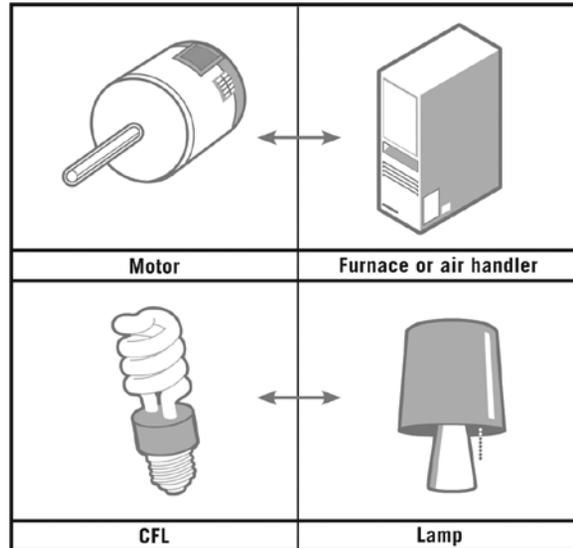

Benefits

- Energy Savings
- Quiet Operation
- Comfort
- Indoor Air Quality
- Easy Installation

Sales Opportunity

- Repair – Failed PSC motor with ECM technology
- Replace – PSC motor with ECM technology
- Upgrade – PSC motor upgrade with ECM technology
- IAQ Packaging

Talking Points:

- Consumers can save up to \$350/year on heating and cooling bills.
- Reduce your stock of PSC motors and stock Evergreen, your ultimate retrofit.
- Become an Evergreen Certified Dealer today.
Go to: www.EvergreenDealer.com to find out how.

AVERAGE ANNUAL ENERGY SAVINGS

Heat and Cool Operation	up to \$78 at 12¢/kWh*	
Constant Fan Operation	up to \$564 at 12¢/kWh*	

Contact Information:



For complete details, visit: www.EvergreenDealer.com or www.thedealertools.com

Evergreen® and Genteq™ are registered trademarks of Regal Beloit Corporation. ©2010TMA



Cat. #6001

Features

- Integrated with HVAC system controls/operation
- Contractor Application Flexibility: Multi-Horse Power, Dual Voltage, Dual Rotation, 5 Speeds: 4 Heat & Cool Selections + 1 Low Speed Fan
- Optimized constant fan speed
- Incorporates BlakBox™ fault reporting

Benefits

- Comfort and Air Quality Improvement with use of Energy Efficient Low Speed Constant Fan
- Reduce truck stock, no capacitors to change out or stock
- Energy Savings

Applications

Replacement for any PSC air-handler motor. Air handler applications including package systems that do not incorporate fossil fuel

NOTE: Evergreen AH® is not intended for use on fossil fuel systems, belt drive systems, or twinned systems.
Not approved to replace existing ECM Variable Speed or X13 motors.
Please see www.EvergreenDealer.com for details.

Evergreen AH ® Motors - 208-230 Volt

HP	RPM	Speeds	Volts	Rotation	FLA @ NP	Catalog No.	C Dim.	Hz	Notes
1/2	1075	1	208-230	CCW	4.1	6001	10.67	60/50	14
	1075	1	208-230	CW	4.1	6002	10.67	60/50	14
1	1075	1	208-230	CCW	7.6	6003	12.17	60/50	14
	1075	1	208-230	CW	7.6	6004	12.17	60/50	14



Cat. #6005

Features

- Integrated with HVAC system controls/operation
- Contractor Application Flexibility: Multi-Horse Power, Dual Voltage, Dual Rotation, 5 Speeds: 4 Heat & Cool Selections + 1 Low Speed Fan
- Optimized constant fan speed
- Incorporates BlakBox™ fault reporting
- Reversible rotation
- Includes 2 bolts and instruction sheet

Benefits

- Comfort and Air Quality Improvement with use of Energy Efficient Low Speed Constant Fan
- Two motors cover all applications, reduce truck stock, no capacitors to change out or stock
- Energy Savings

Applications

Replacement for factory NEMA 48 frame PSC blower motors in residential and light commercial HVAC systems.

NOTE: Evergreen IM® is not intended for use on belt drive systems or twinned systems.

Not approved to replace existing ECM Variable Speed or X13 motors.

Please see www.EvergreenDealer.com for details.



Rotation Sensing Technology™



Evergreen IM® Motors - 115/230 Volt

HP	RPM	Speeds	Volts	Rotation	FLA @ NP	Catalog No.	C Dim.	Hz	Notes
1/2	1070	1	115/230	CCW/CW	6.7/4.0	6005	11.26	60/50	14
1	1070	1	115/230	CCW/CW	11.0/6.7	6010	12.76	60/50	14

**GENTEQ™ EVERGREEN®
EVERGREEN® ACCESSORIES**



Kit includes a motor support, grommet centers, grommet rings, sleeve spacers, 5/16-18 X 1 3/4" bolt, 1/4-20 serrated flange nuts, 1/4" flat washers, 1/4" 20 X 1-3/4" bolts and 5/16 square nut.

Evergreen® Motor Belly Band Mounting Kits

Description	Multplier Symbol	Catalog No.
10" mounting kit	RB3KITS	5K003
11" mounting kit	RB3KITS	5K004
13" mounting kit	RB3KITS	5K005



Cat. #6010CTL

Includes Evergreen control, 2 screws and an instruction sheet.

Evergreen IM® Replacement Modules

Description	Multplier Symbol	Catalog No.	When Used
1/2 HP RMOD	RB3KITS	6005CTL	For catalog model 6005
1 HP RMOD	RB3KITS	6010CTL	For catalog model 6010

CATALOG NUMBER CROSS-REFERENCE
Catalog Number To Model Number

Cat. No.	Model No.	List Price	Multiplier Symbol	Page No.	Cat. No.	Model No.	List Price	Multiplier Symbol	Page No.	Cat. No.	Model No.	List Price	Multiplier Symbol	Page No.
2090	5KCP29GK4566S	\$146	RB1HVC	147	3028	5KCP39GGA769S	\$79	RB1HVC	145	3200	5KCP39FFBA65S	\$101	RB1HVC	146
2091	5KCP29GK4685S	\$97	RB1HVC	147	3029	5KCP39LGA770S	\$84	RB1HVC	145	3201	5KCP39CFBA77S	\$99	RB1HVC	147
2243	5KCP29DCA323S	\$93	RB1HVC	147	3030	5KCP39NGS429S	\$93	RB1HVC	145	3202	5KCP39DFBA68S	\$101	RB1HVC	147
2244	5KCP29JCA324S	\$121	RB1HVC	147	3031	5KCP39LGC003S	\$100	RB1HVC	145	3203	5KCP39FFBA50S	\$103	RB1HVC	146
2245	5KCP29JCA325S	\$121	RB1HVC	152	3032	5KCP39NGL785S	\$108	RB1HVC	145	3204	5KCP39JFBA53S	\$119	RB1HVC	147
2246	5KCP29HCA326S	\$113	RB1HVC	157	3034	5KCP39PFBA57S	\$211	RB1HVC	145	3205	5KCP39NFBA52S	\$124	RB1HVC	147
2247	5KCP29JCA327S	\$106	RB1HVC	160	3035	5KCP39NFBA73S	\$161	RB1HVC	145	3206	5KCP39EGC336S	\$102	RB1HVC	147
2248	5KCP29ECA328S	\$98	RB1HVC	159	3036	5KCP39RFBA75S	\$174	RB1HVC	145	3208	5KCP39JGC337S	\$108	RB1HVC	155
2249	5KCP29DCA329S	\$98	RB1HVC	161	3037	5KCP39PFU680S	\$126	RB1HVC	145	3209	5KCP39NFBA76S	\$159	RB1HVC	158
2250	5KCP29ECA321S	\$126	RB1HVC	138	3038	5KCP39SGY699S	\$112	RB1HVC	145	3210	5KCP39HGC338S	\$110	RB1HVC	157
2251	5KCP29FCA322S	\$118	RB1HVC	138	3040	5KCP39LFB71S	\$117	RB1HVC	145	3212	5KCP39NGC339S	\$113	RB1HVC	157
2362	5KCP29CK4534S	\$137	RB1HVC	138	3046	5KCP39GGC124S	\$95	RB1HVC	145	3214	5KCP39MGC340S	\$115	RB1HVC	157
2743	5KCP29BK8219S	\$84	RB1HVC	138	3047	5KCP39GGD320S	\$132	RB1HVM	151	3215	5KCP39CGP070S	\$107	RB1HVC	155
2746	5KCP29GK8218S	\$103	RB1HVC	138	3048	5KCP39SGL762S	\$130	RB1HVC	145	3219	5KCP39DGP089S	\$126	RB1HVC	155
2820	5KCP29EG5850S	\$117	RB1HVC	138	3049	5KCP39NFBA78S	\$126	RB1HVC	145	3220	5KCP39CGP088S	\$77	RB1HVM	146
2821	5KCP29GG5851S	\$120	RB1HVC	138	3050	5KCP39PG9701S	\$156	RB1HVC	156	3221	5KCP39FGP087S	\$89	RB1HVC	146
2822	5KCP29KG5852S	\$126	RB1HVC	138	3056	5KCP39LGM011S	\$147	RB1HVC	151	3222	5KCP39BGT944S	\$102	RB1HVC	146
2823	5KCP29LG5853S	\$140	RB1HVC	138	3058	5KCP39DGY705S	\$168	RB1HVM	154	3225	5KCP39HGU549S	\$175	RB1HVC	146
2824	5KCP29EG5854S	\$126	RB1HVC	138	3065	5KCP39EGV958S	\$126	RB1HVC	149	3226	5KCP39LGU550S	\$159	RB1HVC	139
2825	5KCP29KG5855S	\$133	RB1HVC	138	3066	5KCP39JGJ997T	\$134	RB1HVC	150	3227	5KCP39EGG401S	\$77	RB1HVC	139
2826	5KCP29KG5856S	\$135	RB1HVC	138	3067	5KCP39PGC910S	\$266	RB1HVM	154	3228	5KCP39HGG402S	\$81	RB1HVC	139
2827	5KCP29LG5857S	\$146	RB1HVC	138	3070	5KCP39GGB158S	\$167	RB1HVC	158	3229	5KCP39MGG403S	\$86	RB1HVC	139
2828	5KCP29LG5858S	\$149	RB1HVC	138	3077	5KCP39DGGK013S	\$130	RB1HVC	152	3230	5KCP39SGS428S	\$95	RB1HVC	156
2829	5KCP29MG5859S	\$163	RB1HVC	138	3078	5KCP39DGGK014S	\$149	RB1HVC	151	3251	5KCP39DGG3304S	\$140	RB1HVC	138
2830	5KCP29BG5860S	\$137	RB1HVC	138	3082	5KCP39HGGK018S	\$99	RB1HVC	156	3252	5KCP39CGT945S	\$142	RB1HVC	139
2831	5KCP29DG5861S	\$142	RB1HVC	138	3084	5KCP39HGE930S	\$176	RB1HVC	145	3271	5KCP39FG3312S	\$149	RB1HVC	139
2832	5KCP29EG5862S	\$146	RB1HVC	138	3085	5KCP39MGE931S	\$188	RB1HVC	145	3272	5KCP39FGT946S	\$152	RB1HVC	150
2833	5KCP29LG5863S	\$166	RB1HVC	139	3086	5KCP39PGE932S	\$210	RB1HVC	145	3275	5KCP39PGS511S	\$164	RB1HVC	138
2834	5KCP29LG5864S	\$168	RB1HVC	147	3087	5KCP39HGGK020S	\$164	RB1HVC	156	3280	5KCP39KGC519T	\$264	RB1HVC	139
2835	5KCP29EG5867S	\$133	RB1HVC	147	3091	5KCP39KGD368S	\$128	RB1HVC	137	3281	5KCP39KGC3316T	\$162	RB1HVC	145
2836	5KCP29EG5868S	\$149	RB1HVC	147	3092	5KCP39NGD369S	\$150	RB1HVC	137	3282	5KCP39JGT947S	\$164	RB1HVC	145
2837	5KCP29FG5869S	\$146	RB1HVC	147	3094	5KCP39MG5438T	\$196	RB1HVC	137	3288	5KCP39SGU073S	\$164	RB1HVC	145
2840	5KCP29BG5866S	\$126	RB1HVC	147	3103	5KCP39PGA749T	\$210	RB1HVC	137	3290	5KCP39PGC520T	\$271	RB1HVM	145
2925	5KCP29DG3401S	\$117	RB1HVC	147	3114	5KCP39HGG7728S	\$172	RB1HVC	148	3292	5KCP39NGD123T	\$187	RB1HVC	145
2926	5KCP29DG3403S	\$102	RB1HVC	147	3122	5KCP39GGB907S	\$177	RB1HVC	160	3327	5KCP39DGP081S	\$71	RB1HVD	136
2927	5KCP29FG3405S	\$119	RB1HVC	147	3123	5KCP39HGA206S	\$150	RB1HVC	151	3328	5KCP39EGP697S	\$75	RB1HVD	136
2928	5KCP29FG3407S	\$104	RB1HVC	157	3124	5KCP39KGB906S	\$172	RB1HVM	151	3329	5KCP39HGP698S	\$80	RB1HVD	136
2950	5KCP29DG3402S	\$119	RB1HVC	161	3128	5KCP39KGC100T	\$174	RB1HVC	155	3330	5KCP39MGK209S	\$89	RB1HVD	136
2952	5KCP29DG3404S	\$104	RB1HVC	154	3132	5KCP39PGC138S	\$177	RB1HVC	150	3331	5KCP39PFM210S	\$108	RB1HVD	136
2953	5KCP29FG3406S	\$121	RB1HVC	154	3134	5KCP39KGB909S	\$151	RB1HVC	148	3383	5KCP39FGM421S	\$80	RB1HVD	136
2954	5KCP29FG3408S	\$106	RB1HVC	151	3143	5KCP39NGT583S	\$106	RB1HVC	156	3384	5KCP39FGM433S	\$80	RB1HVD	136
2955	5KCP29HG8964S	\$115	RB1HVC	155	3144	5KCP39HGT584S	\$100	RB1HVC	156	3385	5KCP39HGAA06AS	\$83	RB1HVD	136
2956	5KCP29GK8966S	\$105	RB1HVC	154	3153	5KCP39CGN330S	\$85	RB1HVC	158	3386	5KCP39HGAA11AT	\$85	RB1HVD	136
2957	5KCP29DG8965S	\$108	RB1HVC	145	3154	5KCP39FGN329S	\$91	RB1HVC	158	3387	5KCP39PGM438S	\$100	RB1HVD	136
3001	5KCP39KG1369S	\$157	RB1HVM	154	3155	5KCP39GGN333S	\$114	RB1HVC	158	3388	5KCP39NGM437S	\$102	RB1HVD	136
3005	5KCP39PGC092S	\$167	RB1HVM	151	3158	5KCP39FGP028S	\$122	RB1HVC	149	3389	5KCP39PGN091S	\$114	RB1HVD	136
3009	5KCP39GG3611S	\$160	RB1HVC	155	3159	5KCP39HGP029S	\$141	RB1HVC	149	3390	5KCP39PGN092S	\$116	RB1HVD	136
3012	5KCP39GG5606S	\$164	RB1HVM	154	3160	5KCP39CGP031S	\$115	RB1HVC	148	3403	5KCP39FFAC99S	\$93	RB1HVC	146
3026	5KCP39NFBA66S	\$126	RB1HVC	145	3161	5KCP39HGP030S	\$129	RB1HVC	146	3404	5KCP39JFAC97S	\$107	RB1HVC	146
3027	5KCP39DGA768T	\$75	RB1HVC	145	3166	5KCP39MGP041S	\$149	RB1HVC	146	3405	5KCP39LFAD03S	\$112	RB1HVC	146



GE Commercial Motors

By Regal-Beloit

Data subject to change without notice

CATALOG NUMBER CROSS-REFERENCE
Catalog Number To Model Number

Cat. No.	Model No.	List Price	Multiplier Symbol	Page No.	Cat. No.	Model No.	List Price	Multiplier Symbol	Page No.	Cat. No.	Model No.	List Price	Multiplier Symbol	Page No.
3428	5KCP39HGH612S	\$89	RB1HVC	146	3696	5KCP39NGA407S	\$118	RB1HVC	146	3913	5KCP39NGY835S	\$153	RB1HVC	154
3429	5KCP39MGH613S	\$98	RB1HVC	146	3698	5KCP39PGA854S	\$209	RB1HVC	146	3914	5KCP39JFY840S	\$117	RB1HVC	153
3430	5KCP39SGL784S	\$110	RB1HVC	146	3727	5KCP39DGS375S	\$69	RB1HVD	146	3915	5KCP39GGY839S	\$108	RB1HVC	152
3431	5KCP39SGH640S	\$132	RB1HVC	146	3728	5KCP39FGM599S	\$73	RB1HVD	146	3916	5KCP39HGY842S	\$126	RB1HVC	153
3452	5KCP39CG3326S	\$154	RB1HVC	139	3729	5KCP39LGS407S	\$78	RB1HVD	146	3917	5KCP39JFY832S	\$127	RB1HVC	152
3453	5KCP39DGY702S	\$144	RB1HVC	139	3730	5KCP39PGS618S	\$86	RB1HVD	146	3918	5KCP39KGY834S	\$158	RB1HVC	159
3454	5KCP39FGY704S	\$148	RB1HVC	139	3731	5KCP39SGT039S	\$110	RB1HVD	146	3919	5KCP39PFY829S	\$146	RB1HVC	160
3455	5KCP39DGY703S	\$152	RB1HVC	139	3732	5KCP39FGL114S	\$89	RB1HVD	146	3920	5KCP39RFY828S	\$156	RB1HVC	159
3458	5KCP39JGU530S	\$86	RB1HVM	141	3733	5KCP39LGL786S	\$94	RB1HVD	146	3921	5KCP39SFU729S	\$185	RB1HVC	160
3459	5KCP39NFBA51S	\$96	RB1HVM	141	3734	5KCP39PGL811S	\$106	RB1HVD	146	3922	5KCP39SGY830S	\$165	RB1HVC	159
3463	5KCP39KGV804S	\$96	RB1HVM	140	3735	5KCP39SGL938S	\$135	RB1HVD	146	3923	5KCP39LGY844S	\$125	RB1HVC	150
3464	5KCP39KGV805S	\$98	RB1HVM	140	3736	5KCP39FGL782S	\$119	RB1HVD	146	3924	5KCP39GGY845S	\$117	RB1HVC	158
3465	5KCP39KGU361S	\$88	RB1HVM	141	3737	5KCP39MGL796S	\$129	RB1HVD	146	3925	5KCP39SGU734S	\$176	RB1HVC	150
3466	5KCP39RGU706S	\$120	RB1HVM	140	3738	5KCP39PGL795S	\$146	RB1HVD	146	3983	5KCP39HGBA99S	\$97	RB1HVM	135
3467	5KCP39NGU364S	\$124	RB1HVM	140	3739	5KCP39SGL794S	\$173	RB1HVD	135	3984	5KCP39HGBB02S	\$99	RB1HVM	135
3468	5KCP39PGU419S	\$108	RB1HVM	141	3740	5KCP39TFBA85S	\$176	RB1HVC	135	3985	5KCP39MGBB01S	\$107	RB1HVM	135
3469	5KCP39PGU418S	\$98	RB1HVM	141	3746	5KCP39SFAD04S	\$121	RB1HVC	135	3986	5KCP39LGBB03S	\$109	RB1HVM	135
3470	5KCP39GGC521T	\$229	RB1HVC	138	3759	5KCP39LGT378S	\$129	RB1HVC	135	3987	5KCP39RGBB08AS	\$127	RB1HVM	135
3471	5KCP39EG3332S	\$157	RB1HVC	139	3760	5KCP39PGT377S	\$158	RB1HVC	135	3988	5KCP39PGBB07S	\$129	RB1HVM	135
3472	5KCP39DG3334S	\$152	RB1HVM	139	3782	5KCP39DGP729S	\$107	RB1HVC	135	3989	5KCP39RGBB04AS	\$157	RB1HVM	135
3481	5KCP39GG3336S	\$166	RB1HVC	139	3783	5KCP39GGP730S	\$109	RB1HVC	135	3990	5KCP39RGBB06S	\$159	RB1HVM	135
3482	5KCP39GG3338S	\$168	RB1HVC	139	3784	5KCP39FGP731S	\$111	RB1HVC	135	3992	5KCP39FGE211S	\$163	RB1HVC	136
3490	5KCP39NGC522S	\$265	RB1HVC	138	3785	5KCP39LGP732S	\$112	RB1HVC	135	3993	5KCP39FGE212S	\$165	RB1HVC	136
3583	5KCP39EGAA09S	\$82	RB1HVD	136	3786	5KCP39JGP733S	\$114	RB1HVC	137	3994	5KCP39HGE213S	\$169	RB1HVC	136
3584	5KCP39EGAA10S	\$84	RB1HVD	136	3787	5KCP39PGP734S	\$130	RB1HVC	137	3995	5KCP39HGE214S	\$171	RB1HVC	136
3585	5KCP39HGAA37T	\$85	RB1HVD	136	3788	5KCP39NGP735S	\$132	RB1HVC	137	3996	5KCP39MGE215S	\$182	RB1HVC	136
3586	5KCP39JGN654T	\$87	RB1HVD	136	3789	5KCP39PGP736S	\$145	RB1HVC	137	3997	5KCP39LGE216T	\$184	RB1HVC	136
3587	5KCP39PGN655S	\$103	RB1HVD	136	3790	5KCP39PGP737S	\$147	RB1HVC	137	3998	5KCP39PGE415S	\$202	RB1HVC	136
3588	5KCP39MGAA36S	\$105	RB1HVD	136	3851	5KCP39CG9044S	\$145	RB1HVC	137	3999	5KCP39PGE416S	\$204	RB1HVC	136
3589	5KCP39NGAA44S	\$118	RB1HVD	136	3852	5KCP39CG9045S	\$147	RB1HVC	137	5100	5SME59BLA1036	\$170	RB1E84	133
3590	5KCP39PGN658S	\$120	RB1HVD	136	3862	5KCP39CG9047S	\$147	RB1HVC	137	5101	5SME59BLA1038	\$170	RB1E84	133
3591	5KCP39NGL571S	\$202	RB1HVC	156	3871	5KCP39FG9048S	\$159	RB1HVC	137	5102	5SME59BLA1058	\$169	RB1E84	133
3592	5KCP39HGR677S	\$143	RB1HVC	156	3872	5KCP39EG9049S	\$162	RB1HVC	137	5103	5SME59BLA1060	\$169	RB1E84	133
3595	5KCP39SGL854S	\$180	RB1HVC	136	3881	5KCP39HG9050S	\$166	RB1HVC	150	5104	5SME59BLA1079	\$175	RB1E84	133
3596	5KCP39SGL853S	\$182	RB1HVC	136	3882	5KCP39GG9051T	\$168	RB1HVC	150	5105	5SME59DVA1005	\$145	RB1E84	133
3631	5KCP39CG5822S	\$117	RB1HVC	137	3891	5KCP39MG5312S	\$181	RB1HVC	158	5106	5SME59DVA1004	\$145	RB1E84	133
3632	5KCP39CG5823S	\$120	RB1HVC	137	3892	5KCP39MG5313T	\$183	RB1HVC	159	5110	5SME59BLA1065	\$175	RB1E84	133
3641	5KCP39CG5824S	\$117	RB1HVC	137	3898	5KCP39PGA853S	\$215	RB1HVC	149	5111	5SME59BLA1066	\$175	RB1E84	133
3642	5KCP39CG5825S	\$120	RB1HVC	137	3901	5KCP39PGU719S	\$156	RB1HVC	149	5120	5SME59BLA1068	\$174	RB1E84	133
3651	5KCP39DG5826T	\$100	RB1HVC	137	3902	5KCP39NGY813S	\$164	RB1HVC	148	5121	5SME59BLA1067	\$174	RB1E84	133
3652	5KCP39CG5827S	\$120	RB1HVC	137	3903	5KCP39RGY787S	\$174	RB1HVC	158	5200	5SME59BLA2037	\$170	RB1E84	133
3656	5KCP39CGA402S	\$92	RB1HVC	137	3904	5KCP39BGY814S	\$108	RB1HVC	159	5201	5SME59BLA2039	\$170	RB1E84	133
3671	5KCP39GG5828S	\$127	RB1HVC	137	3905	5KCP39EGY823S	\$107	RB1HVC	149	5202	5SME59BLA2059	\$169	RB1E84	133
3672	5KCP39FG5829T	\$126	RB1HVC	137	3906	5KCP39GGY822S	\$123	RB1HVC	149	5203	5SME59BLA2061	\$169	RB1E84	133
3676	5KCP39FGA403T	\$95	RB1HVC	137	3907	5KCP39BGY824S	\$98	RB1HVC	148	5204	5SME59BLA2080	\$175	RB1E84	133
3681	5KCP39LG5830T	\$137	RB1HVC	137	3908	5KCP39BGY825S	\$98	RB1HVC	148	5205	5SME59DVA2007	\$145	RB1E84	133
3682	5KCP39JG5831T	\$135	RB1HVC	137	3909	5KCP39GGY826S	\$115	RB1HVC	149	5206	5SME59DVA2006	\$145	RB1E84	171
3686	5KCP39JGA406T	\$100	RB1HVC	146	3910	5KCP39FGY827S	\$109	RB1HVC	149	5210	5SME59BLA2070	\$175	RB1E84	171
3691	5KCP39PG5081T	\$160	RB1HVC	146	3911	5KCP39BGY831S	\$98	RB1HVC	152	5211	5SME59BLA2071	\$175	RB1E84	171
3692	5KCP39NG5082S	\$158	RB1HVC	146	3912	5KCP39GGY833S	\$133	RB1HVC	152	5220	5SME59BLA2069	\$174	RB1E84	171



GE Commercial Motors

By Regal-Beloit

CATALOG NUMBER CROSS-REFERENCE
Catalog Number To Model Number

Cat. No.	Model No.	List Price	Multiplier Symbol	Page No.	Cat. No.	Model No.	List Price	Multiplier Symbol	Page No.	Cat. No.	Model No.	List Price	Multiplier Symbol	Page No.
5221	5SME59BLA2072	\$174	RB1E84	172	3S003	5KCP39GFY917S	\$137	RB1HVC	148	97F8036S	97F8036	\$7.76	CP03	165
6001	5SME39HXL077	\$270	RB1E23	172	3S004	5KCP39CFY918S	\$116	RB1HVC	152	97F8037S	97F8037	\$9.81	CP03	165
6002	5SME39HXL095	\$270	RB1E23	164	3S005	5KCP39CGY919S	\$113	RB1HVC	153	97F8038S	97F8038	\$10.83	CP03	165
6003	5SME39SXL078	\$340	RB1E23	164	3S006	5KCP39DFY920S	\$140	RB1HVC	153	97F8039S	97F8039	\$11.81	CP03	165
6004	5SME39SXL096	\$340	RB1E23	164	3S007	5KCP39FFY921S	\$125	RB1HVC	153	97F8040S	97F8040	\$12.79	CP03	165
6005	5SME39HXL110	\$325	RB1E23	164	3S008	5KCP39FGY922S	\$129	RB1HVC	153	97F8042S	97F8042	\$14.79	CP03	165
6010	5SME39SXL111	\$410	RB1E23	164	3S009	5KCP39GGY923S	\$125	RB1HVC	153	97F8044S	97F8044	\$17.28	CP03	165
2S001	5KCP29KK8983S	\$117	RB1HVC	155	3S010	5KCP39KGY924S	\$145	RB1HVC	154	97F8049S	97F8049	\$23.32	CP03	165
2S002	5KCP29FK8997S	\$107	RB1HVC	160	3S011	5KCP39KGY925S	\$149	RB1HVC	154	97F8050S	97F8050	\$24.26	CP03	165
2S003	5KCP29ECA426S	\$99	RB1HVC	151	3S012	5KCP39BGY926S	\$98	RB1HVC	152	97F8052S	97F8052	\$26.38	CP03	165
2S004	5KCP29BCA427S	\$117	RB1HVC	144	3S013	5KCP39FFY927S	\$117	RB1HVC	159	97F8053S	97F8053	\$30.15	CP03	165
2S005	5KCP29CCA428S	\$98	RB1HVC	144	3S014	5KCP39LGY928S	\$143	RB1HVC	159	97F8054S	97F8054	\$4.95	CP03	164
2S006	5KCP29HKB023S	\$122	RB1HVC	144	3S015	5KCP39GGY929S	\$117	RB1HVC	157	97F8055S	97F8055	\$5.17	CP03	164
2S007	5KCP29BG6688S	\$115	RB1HVC	144	3S016	5KCP39NGY930S	\$115	RB1HVC	158	97F8056S	97F8056	\$5.50	CP03	164
2S009	5KCP29KGB137S	\$126	RB1HVC	144	3S017	5KCP39HGY931S	\$125	RB1HVC	157	97F8057S	97F8057	\$5.70	CP03	164
3202HS	5KCP39DFBA81S	\$107	RB1HVC	144	3S018	5KCP39BGY932S	\$103	RB1HVC	160	97F8058S	97F8058	\$6.05	CP03	164
3203HS	5KCP39HFBA79S	\$109	RB1HVC	144	3S019	5KCP39EGY933S	\$110	RB1HVC	160	97F8059S	97F8059	\$5.70	CP03	164
3204HS	5KCP39JFBA83S	\$131	RB1HVC	143	3S020	5KCP39JFY934S	\$125	RB1HVC	161	97F8060S	97F8060	\$7.42	CP03	164
3205HS	5KCP39NFBA82S	\$136	RB1HVC	143	3S021	5KCP39LGY935S	\$135	RB1HVC	133	97F8061S	97F8061	\$8.01	CP03	165
3403HS	5KCP39HFAD05S	\$97	RB1HVC	142	3S022	5KCP39NGY936S	\$139	RB1HVC	133	97F8063S	97F8063	\$9.22	CP03	165
3404HS	5KCP39JFAD07S	\$111	RB1HVC	142	5K003	24X328019-G1	\$25	RB3KITS	133	97F8064S	97F8064	\$10.28	CP03	165
3405HS	5KCP39NFAD09S	\$116	RB1HVC	143	5K004	24X328019-G2	\$27	RB3KITS	133	97F8065S	97F8065	\$11.29	CP03	165
3456HS	5KCP39LGY816S	\$86	RB1HVM	143	5K005	24X328019-G3	\$32	RB3KITS	134	97F8066S	97F8066	\$12.50	CP03	165
3457HS	5KCP39NFAD13S	\$96	RB1HVM	142	5R002	5SME39DLHE044	\$230	RB1E23	134	97F8067S	97F8067	\$13.51	CP03	165
3458HS	5KCP39LGU721S	\$88	RB1HVM	143	5R004	5SME39DLHE053	\$230	RB1E23	134	97F8068S	97F8068	\$19.28	CP03	165
3459HS	5KCP39NFBA87S	\$98	RB1HVM	142	5R005	5SME39HLHE052	\$235	RB1E23	134	97F8069S	97F8069	\$16.15	CP03	165
3460HS	5KCP39RGU709S	\$108	RB1HVM	143	5R007	5SME39HLHE043	\$235	RB1E23	134	97F8070S	97F8070	\$17.18	CP03	165
3461HS	5KCP39TFBA86S	\$120	RB1HVM	143	5R016	SSC2B12CSHEMA1	\$86	RB1E84	134	97F8071S	97F8071	\$19.45	CP03	165
3465HS	5KCP39LGU735S	\$92	RB1HVM	142	5R017	SSC2B18AHEMAR1	\$92	RB1E84	134	97F8072S	97F8072	\$20.46	CP03	165
3468HS	5KCP39RGU733S	\$112	RB1HVM	143	5R018	SSC2B19AHEMAR2	\$106	RB1E84	134	97F8073S	97F8073	\$21.75	CP03	165
3469HS	5KCP39SGU732S	\$102	RB1HVM	142	5R019	SSC2B15CSHEMA2	\$100	RB1E84	134	97F9002S	97F9002	\$5.97	CP03	164
3725HS	5KCP39DFAD06S	\$95	RB1HVC	144	5R020	SSC2B13CSHEMA1	\$88	RB1E84	134	97F9010S	97F9010	\$16.04	CP03	165
3726HS	5KCP39DGU716S	\$87	RB1HVD	144	5R021	SSC2B16CSHEMA1	\$90	RB1E84	172	97F9011S	97F9011	\$19.25	CP03	165
3727HS	5KCP39DGY797S	\$75	RB1HVD	144	5R022	SSC2B18AHMAR1	\$98	RB1E84	172	97F9012S	97F9012	\$20.53	CP03	165
3728HS	5KCP39GGY796S	\$79	RB1HVD	144	5R023	SSC2B19AHMAR2	\$112	RB1E84	165	97F9602S	97F9602	\$8.25	CP03	165
3729HS	5KCP39LGY801S	\$84	RB1HVD	144	5R024	SSC2B12CSHEV1	\$106	RB1E84	165	97F9606S	97F9606	\$9.12	CP03	165
3730HS	5KCP39RGY799S	\$93	RB1HVD	144	5R025	SSC2B12CSHEMV1	\$85	RB1E84	164	97F9608S	97F9608	\$10.08	CP03	165
3731HS	5KCP39SGY805S	\$120	RB1HVD	144	6005CTL	RPHXL110P0133	\$200	RB1E23	164	97F9613S	97F9613	\$16.68	CP03	165
3732HS	5KCP39GGU714S	\$99	RB1HVD	144	6010CTL	RPSXL111P0134	\$250	RB1E23	164	97F9614S	97F9614	\$12.03	CP03	165
3733HS	5KCP39LGU715S	\$104	RB1HVD	144	97F5001S	97F5001	\$7.33	CP03	165	97F9625S	97F9625	\$7.51	CP03	165
3734HS	5KCP39RGU718S	\$113	RB1HVD	144	97F5276S	97F5276	\$18.17	CP03	165	97F9626S	97F9626	\$7.13	CP03	165
3735HS	5KCP39SGU717S	\$139	RB1HVD	144	97F5388S	97F5388	\$7.46	CP03	164	97F9632S	97F9632	\$10.01	CP03	165
3736HS	5KCP39HGU722S	\$129	RB1HVD	144	97F5706S	97F5706	\$5.17	CP03	164	97F9635S	97F9635	\$11.01	CP03	165
3737HS	5KCP39NGU724S	\$139	RB1HVD	144	97F6749S	97F6749	\$7.73	CP03	164	97F9638S	97F9638	\$20.28	CP03	164
3738HS	5KCP39RGU723S	\$153	RB1HVD	144	97F6755S	97F6755	\$11.36	CP03	164	97F9802S	97F9802	\$14.36	CP03	165
3739HS	5KCP39SGU725S	\$184	RB1HVD	144	97F6759S	97F6759	\$10.95	CP03	164	97F9815S	97F9815	\$29.48	CP03	165
3746HS	5KCP39TFAD10S	\$125	RB1HVC	144	97F6763S	97F6763	\$6.65	CP03	164	97F9834S	97F9834	\$19.48	CP03	165
3747HS	5KCP39TFBA84S	\$145	RB1HVC	144	97F6766S	97F6766	\$5.81	CP03	164	97F9848S	97F9848	\$21.12	CP03	165
3S001	5KCP39BGY915S	\$96	RB1HVC	148	97F6823S	97F6823	\$10.45	CP03	164	97F9849S	97F9849	\$20.28	CP03	165
3S002	5KCP39BGY916S	\$116	RB1HVC	148	97F6836S	97F6836	\$15.01	CP03	164	97F9851S	97F9851	\$26.74	CP03	165



CATALOG NUMBER CROSS-REFERENCE
Catalog Number To Model Number

Cat. No.	Model No.	List Price	Multiplier Symbol	Page No.	Cat. No.	Model No.	List Price	Multiplier Symbol	Page No.	Cat. No.	Model No.	List Price	Multiplier Symbol	Page No.
97F9874S	97F9874	\$31.54	CP03	165	A487	24X327916AA-G3	\$24	RB3KITS	167	PB300E000A370EAS	PB300E000A370EA	\$9.55	CP03	162
97F9884S	97F9884	\$13.48	CP03	165	A488	24X327916AA-G4	\$26	RB3KITS	167	PB300E000C240CAS	PB300E000C240CA	\$7.93	CP03	162
97F9970S	97F9970	\$23.09	CP03	165	A489	24X327916AA-G5	\$28	RB3KITS	168	PB300E000C440DAS	PB300E000C440DA	\$17.70	CP03	162
97F9978S	97F9978	\$17.75	CP03	165	A490	24X327916AA-G6	\$30	RB3KITS	162	PB300E000P440DAS	PB300E000P440DA	\$10.30	CP03	163
A195	161L110AA1	\$2	RB2KITS	167	A493	24X327930-G3	\$12	RB3KITS	162	PB350E000A370EAS	PB350E000A370EA	\$12.17	CP03	162
A224	161L115AAG1	\$3	RB2KITS	168	A494	24X327930-G2	\$12	RB3KITS	162	PB350E000C240DAS	PB350E000C240DA	\$9.54	CP03	162
A447	8794700FSG01	\$100	RB1EACC	169	A518	161L110AA4	\$2	RB2KITS	162	PB350E000C440DAS	PB350E000C440DA	\$19.06	CP03	162
A455	38-100686-G5	\$11	RB3KITS	166	A556	24X327921-G11	\$27	RB3KITS	162	PB350Z050S440EAS	PB350Z050S440EA	\$19.85	CP03	163
A459	24X327930-G1	\$4	RB3KITS	167	PB030E000A440AAS	PB030E000A440AA	\$3.93	CP03	162	PB400E000C370DAS	PB400E000C370DA	\$16.57	CP03	162
A460	24X327930-G4	\$12	RB3KITS	167	PB040E000A440AAS	PB040E000A440AA	\$4.41	CP03	162	PB400E000C440DAS	PB400E000C440DA	\$20.38	CP03	162
A461	161L113AM-G3	\$20	RB3KITS	166	PB050E000A370AAS	PB050E000A370AA	\$4.09	CP03	162	PB450E000C370DAS	PB450E000C370DA	\$20.20	CP03	162
A462	161L113AM-G4	\$20	RB3KITS	166	PB050E000A440BAS	PB050E000A440BA	\$4.14	CP03	162	PB450E000C440EAS	PB450E000C440EA	\$13.27	CP03	162
A463	161L113AM-G6	\$20	RB3KITS	166	PB060E000A370BAS	PB060E000A370BA	\$4.69	CP03	162	PB450Z050T440DAS	PB450Z050T440DA	\$24.07	CP03	163
A464	161L113AM-G7	\$20	RB3KITS	166	PB060E000A440BAS	PB060E000A440BA	\$4.47	CP03	162	PB500E000C370DAS	PB500E000C370DA	\$15.31	CP03	162
A465	161L113AM-G8	\$20	RB3KITS	166	PB075E000A370BAS	PB075E000A370BA	\$4.57	CP03	162	PB550E000D440EAS	PB550E000D440EA	\$26.68	CP03	162
A466	161L113AM-G9	\$20	RB3KITS	166	PB075E000A440CAS	PB075E000A440CA	\$5.35	CP03	162	PB550Z075T440EAS	PB550Z075T440EA	\$29.65	CP03	163
A467	161L113AM-G10	\$20	RB3KITS	166	PB100E000A370CAS	PB100E000A370CA	\$5.09	CP03	162	PB600E000D440HAS	PB600E000D440HA	\$16.91	CP03	162
A468	161L113AN-G2	\$20	RB3KITS	166	PB100E000A440CAS	PB100E000A440CA	\$5.55	CP03	162					
A469	161L113AN-G3	\$20	RB3KITS	166	PB125E000A370CAS	PB125E000A370CA	\$5.50	CP03	162					
A470	161L113AN-G4	\$20	RB3KITS	166	PB125E000A440DAS	PB125E000A440DA	\$6.57	CP03	162					
A471	161L113AN-G5	\$20	RB3KITS	166	PB125E000P440CAS	PB125E000P440CA	\$6.63	CP03	163					
A472	161L113AN-G6	\$20	RB3KITS	168	PB150E000A370CAS	PB150E000A370CA	\$6.09	CP03	162					
A473	161L113AN-G7	\$20	RB3KITS	168	PB150E000A440EAS	PB150E000A440EA	\$6.69	CP03	162					
A474	161L113AN-G8	\$20	RB3KITS	167	PB150E000P440CAS	PB150E000P440CA	\$6.67	CP03	163					
A475	161L113AN-G9	\$20	RB3KITS	167	PB175E000A370DAS	PB175E000A370DA	\$7.68	CP03	162					
A476	161L113AN-G10	\$20	RB3KITS	166	PB200E000A370DAS	PB200E000A370DA	\$7.25	CP03	162					
A477	161L131AA-G1	\$10	RB3KITS	166	PB200E000A440EAS	PB200E000A440EA	\$7.80	CP03	162					
A478	161L131AB-G1	\$14	RB3KITS	166	PB200E000P440CAS	PB200E000P440CA	\$6.69	CP03	163					
A483	24X327978-G5	\$7	RB3KITS	166	PB250E000A370DAS	PB250E000A370DA	\$11.31	CP03	162					
A484	24X327978-G4	\$18	RB3KITS	166	PB250E000A440EAS	PB250E000A440EA	\$7.45	CP03	162					
A485	24X327916AA-G1	\$20	RB3KITS	166	PB250E000P440DAS	PB250E000P440DA	\$9.12	CP03	163					
A486	24X327916AA-G2	\$22	RB3KITS	167	PB250Z050S440DAS	PB250Z050S440DA	\$16.68	CP03	163					



GE Commercial Motors

By Regal-Beloit

CATALOG NUMBER CROSS-REFERENCE

Model Number to Catalog Number

Model No.	Cat. No.	List Price	Multiplier Symbol	Page No.	Model No.	Cat. No.	List Price	Multiplier Symbol	Page No.	Model No.	Cat. No.	List Price	Multiplier Symbol	Page No.
161L110AA1	A195	\$2	RB2KITS	167	5KCP29DG3404S	2952	\$104	RB1HVC	154	5KCP39CFY918S	3S004	\$116	RB1HVC	152
161L110AA4	A518	\$2	RB2KITS	162	5KCP29DG5861S	2831	\$142	RB1HVC	138	5KCP39CG3326S	3452	\$154	RB1HVC	139
161L113AM-G10	A467	\$20	RB3KITS	166	5KCP29DG8965S	2957	\$108	RB1HVC	145	5KCP39CG5822S	3631	\$117	RB1HVC	137
161L113AM-G3	A461	\$20	RB3KITS	166	5KCP29ECA321S	2250	\$126	RB1HVC	138	5KCP39CG5823S	3632	\$120	RB1HVC	137
161L113AM-G4	A462	\$20	RB3KITS	166	5KCP29ECA328S	2248	\$98	RB1HVC	159	5KCP39CG5824S	3641	\$117	RB1HVC	137
161L113AM-G6	A463	\$20	RB3KITS	166	5KCP29ECA426S	2S003	\$99	RB1HVC	151	5KCP39CG5825S	3642	\$120	RB1HVC	137
161L113AM-G7	A464	\$20	RB3KITS	166	5KCP29EG5850S	2820	\$117	RB1HVC	138	5KCP39CG5827S	3652	\$120	RB1HVC	137
161L113AM-G8	A465	\$20	RB3KITS	166	5KCP29EG5854S	2824	\$126	RB1HVC	138	5KCP39CG9044S	3851	\$145	RB1HVC	137
161L113AM-G9	A466	\$20	RB3KITS	166	5KCP29EG5862S	2832	\$146	RB1HVC	138	5KCP39CG9045S	3852	\$147	RB1HVC	137
161L113AM-G10	A476	\$20	RB3KITS	166	5KCP29EG5867S	2835	\$133	RB1HVC	147	5KCP39CG9047S	3862	\$147	RB1HVC	137
161L113AN-G2	A468	\$20	RB3KITS	166	5KCP29EG5868S	2836	\$149	RB1HVC	147	5KCP39CGA402S	3656	\$92	RB1HVC	137
161L113AN-G3	A469	\$20	RB3KITS	166	5KCP29FCA322S	2251	\$118	RB1HVC	138	5KCP39CGN330S	3153	\$85	RB1HVC	158
161L113AN-G4	A470	\$20	RB3KITS	166	5KCP29FG3405S	2927	\$119	RB1HVC	147	5KCP39CGP031S	3160	\$115	RB1HVC	148
161L113AN-G5	A471	\$20	RB3KITS	166	5KCP29FG3406S	2953	\$121	RB1HVC	154	5KCP39CGP070S	3215	\$107	RB1HVC	155
161L113AN-G6	A472	\$20	RB3KITS	168	5KCP29FG3407S	2928	\$104	RB1HVC	157	5KCP39CGP088S	3220	\$77	RB1HVM	146
161L113AN-G7	A473	\$20	RB3KITS	168	5KCP29FG3408S	2954	\$106	RB1HVC	151	5KCP39CGT945S	3252	\$142	RB1HVC	139
161L113AN-G8	A474	\$20	RB3KITS	167	5KCP29FG5869S	2837	\$146	RB1HVC	147	5KCP39CGY919S	3S005	\$113	RB1HVC	153
161L113AN-G9	A475	\$20	RB3KITS	167	5KCP29FK8997S	2S002	\$107	RB1HVC	160	5KCP39DFAD06S	3725HS	\$95	RB1HVC	144
161L115AAG1	A224	\$3	RB2KITS	168	5KCP29GG5851S	2821	\$120	RB1HVC	138	5KCP39DFBA68S	3202	\$101	RB1HVC	147
161L131AA-G1	A477	\$10	RB3KITS	166	5KCP29GK4566S	2090	\$146	RB1HVC	147	5KCP39DFBA81S	3202HS	\$107	RB1HVC	144
161L131AB-G1	A478	\$14	RB3KITS	166	5KCP29GK4685S	2091	\$97	RB1HVC	147	5KCP39DFY920S	3S006	\$140	RB1HVC	153
24X327916AA-G1	A485	\$20	RB3KITS	166	5KCP29GK8218S	2746	\$103	RB1HVC	138	5KCP39DG3304S	3251	\$140	RB1HVC	138
24X327916AA-G2	A486	\$22	RB3KITS	167	5KCP29GK8966S	2956	\$105	RB1HVC	154	5KCP39DG3334S	3472	\$152	RB1HVM	139
24X327916AA-G3	A487	\$24	RB3KITS	167	5KCP29HCA326S	2246	\$113	RB1HVC	157	5KCP39DG5826T	3651	\$100	RB1HVC	137
24X327916AA-G4	A488	\$26	RB3KITS	167	5KCP29HG8964S	2955	\$115	RB1HVC	155	5KCP39DGA768T	3027	\$75	RB1HVC	145
24X327916AA-G5	A489	\$28	RB3KITS	168	5KCP29HKB023S	2S006	\$122	RB1HVC	144	5KCP39DGK013S	3077	\$130	RB1HVC	152
24X327916AA-G6	A490	\$30	RB3KITS	162	5KCP29JCA324S	2244	\$121	RB1HVC	147	5KCP39DGK014S	3078	\$149	RB1HVC	151
24X327921-G11	A556	\$27	RB3KITS	162	5KCP29JCA325S	2245	\$121	RB1HVC	152	5KCP39DGP081S	3327	\$71	RB1HVD	136
24X327930-G1	A459	\$4	RB3KITS	167	5KCP29JCA327S	2247	\$106	RB1HVC	160	5KCP39DGP089S	3219	\$126	RB1HVC	155
24X327930-G2	A494	\$12	RB3KITS	162	5KCP29KG5852S	2822	\$126	RB1HVC	138	5KCP39DGP729S	3782	\$107	RB1HVC	135
24X327930-G3	A493	\$12	RB3KITS	162	5KCP29KG5855S	2825	\$133	RB1HVC	138	5KCP39DGS375S	3727	\$69	RB1HVD	146
24X327930-G4	A460	\$12	RB3KITS	167	5KCP29KG5856S	2826	\$135	RB1HVC	138	5KCP39DGU716S	3726HS	\$87	RB1HVD	144
24X327978-G4	A484	\$18	RB3KITS	166	5KCP29KGB137S	2S009	\$126	RB1HVC	144	5KCP39DGY702S	3453	\$144	RB1HVC	139
24X327978-G5	A483	\$7	RB3KITS	166	5KCP29K8983S	2S001	\$117	RB1HVC	155	5KCP39DGY703S	3455	\$152	RB1HVC	139
24X328019-G1	5K003	\$25	RB3KITS	133	5KCP29LG5853S	2823	\$140	RB1HVC	138	5KCP39DGY705S	3058	\$168	RB1HVM	154
24X328019-G2	5K004	\$27	RB3KITS	133	5KCP29LG5857S	2827	\$146	RB1HVC	138	5KCP39DGY797S	3727HS	\$75	RB1HVD	144
24X328019-G3	5K005	\$32	RB3KITS	134	5KCP29LG5858S	2828	\$149	RB1HVC	138	5KCP39EG3332S	3471	\$157	RB1HVC	139
38-100686-G5	A455	\$11	RB3KITS	166	5KCP29LG5863S	2833	\$166	RB1HVC	139	5KCP39EG9049S	3872	\$162	RB1HVC	137
5KCP29BCA427S	2S004	\$117	RB1HVC	144	5KCP29LG5864S	2834	\$168	RB1HVC	147	5KCP39EGAA09S	3583	\$82	RB1HVD	136
5KCP29BG5860S	2830	\$137	RB1HVC	138	5KCP29MG5859S	2829	\$163	RB1HVC	138	5KCP39EGAA10S	3584	\$84	RB1HVD	136
5KCP29BG5866S	2840	\$126	RB1HVC	147	5KCP39BGT944S	3222	\$102	RB1HVC	146	5KCP39EGC336S	3206	\$102	RB1HVC	147
5KCP29BG6688S	2S007	\$115	RB1HVC	144	5KCP39BGY814S	3904	\$108	RB1HVC	159	5KCP39EGG401S	3227	\$77	RB1HVC	139
5KCP29BK8219S	2743	\$84	RB1HVC	138	5KCP39BGY824S	3907	\$98	RB1HVC	148	5KCP39EGP697S	3328	\$75	RB1HVD	136
5KCP29CCA428S	2S005	\$98	RB1HVC	144	5KCP39BGY825S	3908	\$98	RB1HVC	148	5KCP39EGV958S	3065	\$126	RB1HVC	149
5KCP29CK4534S	2362	\$137	RB1HVC	138	5KCP39BGY831S	3911	\$98	RB1HVC	152	5KCP39EGY823S	3905	\$107	RB1HVC	149
5KCP29DCA323S	2243	\$93	RB1HVC	147	5KCP39BGY915S	3S001	\$96	RB1HVC	148	5KCP39EGY933S	3S019	\$110	RB1HVC	160
5KCP29DCA329S	2249	\$98	RB1HVC	161	5KCP39BGY916S	3S002	\$116	RB1HVC	148	5KCP39FFAC99S	3403	\$93	RB1HVC	146
5KCP29DG3401S	2925	\$117	RB1HVC	147	5KCP39BGY926S	3S012	\$98	RB1HVC	152	5KCP39FFBA50S	3203	\$103	RB1HVC	146
5KCP29DG3402S	2950	\$119	RB1HVC	161	5KCP39BGY932S	3S018	\$103	RB1HVC	160	5KCP39FFBA65S	3200	\$101	RB1HVC	146
5KCP29DG3403S	2926	\$102	RB1HVC	147	5KCP39CFBA77S	3201	\$99	RB1HVC	147	5KCP39FFY921S	3S007	\$125	RB1HVC	153



GE Commercial Motors

By Regal-Beloit

CATALOG NUMBER CROSS-REFERENCE
Model Number to Catalog Number

Model No.	Cat. No.	List Price	Multiplier Symbol	Page No.	Model No.	Cat. No.	List Price	Multiplier Symbol	Page No.	Model No.	Cat. No.	List Price	Multiplier Symbol	Page No.
5KCP39FFY927S	3S013	\$117	RB1HVC	159	5KCP39HGAA11AT	3386	\$85	RB1HVD	136	5KCP39LFBA71S	3040	\$117	RB1HVC	145
5KCP39FG3312S	3271	\$149	RB1HVC	139	5KCP39HGAA37T	3585	\$85	RB1HVD	136	5KCP39LG5830T	3681	\$137	RB1HVC	137
5KCP39FG5829T	3672	\$126	RB1HVC	137	5KCP39HGBA99S	3983	\$97	RB1HVM	135	5KCP39LGA770S	3029	\$84	RB1HVC	145
5KCP39FG9048S	3871	\$159	RB1HVC	137	5KCP39HGBB02S	3984	\$99	RB1HVM	135	5KCP39LGBB03S	3986	\$109	RB1HVM	135
5KCP39FGA403T	3676	\$95	RB1HVC	137	5KCP39HGC338S	3210	\$110	RB1HVC	157	5KCP39LGC003S	3031	\$100	RB1HVC	145
5KCP39FGE211S	3992	\$163	RB1HVC	136	5KCP39HGE213S	3994	\$169	RB1HVC	136	5KCP39LGE216T	3997	\$184	RB1HVC	136
5KCP39FGE212S	3993	\$165	RB1HVC	136	5KCP39HGE214S	3995	\$171	RB1HVC	136	5KCP39LGL786S	3733	\$94	RB1HVD	146
5KCP39FGL114S	3732	\$89	RB1HVD	146	5KCP39HGE930S	3084	\$176	RB1HVC	145	5KCP39LGM011S	3056	\$147	RB1HVC	151
5KCP39FGL782S	3736	\$119	RB1HVD	146	5KCP39HGG402S	3228	\$81	RB1HVC	139	5KCP39LGP732S	3785	\$112	RB1HVC	135
5KCP39FGM421S	3383	\$80	RB1HVD	136	5KCP39HGH612S	3428	\$89	RB1HVC	146	5KCP39LGS407S	3729	\$78	RB1HVD	146
5KCP39FGM433S	3384	\$80	RB1HVD	136	5KCP39HKG018S	3082	\$99	RB1HVC	156	5KCP39LGT378S	3759	\$129	RB1HVC	135
5KCP39FGM599S	3728	\$73	RB1HVD	146	5KCP39HKG020S	3087	\$164	RB1HVC	156	5KCP39LGU550S	3226	\$159	RB1HVC	139
5KCP39FGN329S	3154	\$91	RB1HVC	158	5KCP39HGP029S	3159	\$141	RB1HVC	149	5KCP39LGU715S 3733HS	\$104	RB1HVD	144	
5KCP39FGP028S	3158	\$122	RB1HVC	149	5KCP39HGP030S	3161	\$129	RB1HVC	146	5KCP39LGU721S 3458HS	\$88	RB1HVM	143	
5KCP39FGP087S	3221	\$89	RB1HVC	146	5KCP39HGP698S	3329	\$80	RB1HVD	136	5KCP39LGU735S 3465HS	\$92	RB1HVM	142	
5KCP39FGP731S	3784	\$111	RB1HVC	135	5KCP39HGR677S	3592	\$143	RB1HVC	156	5KCP39LGY801S 3729HS	\$84	RB1HVD	144	
5KCP39FGT946S	3272	\$152	RB1HVC	150	5KCP39HGT584S	3144	\$100	RB1HVC	156	5KCP39LGY816S 3456HS	\$86	RB1HVM	143	
5KCP39FGY704S	3454	\$148	RB1HVC	139	5KCP39HGU549S	3225	\$175	RB1HVC	146	5KCP39LGY844S	3923	\$125	RB1HVC	150
5KCP39FGY827S	3910	\$109	RB1HVC	149	5KCP39HGU722S 3736HS	\$129	RB1HVD	144	5KCP39LGY928S	3S014	\$143	RB1HVC	159	
5KCP39FGY922S	3S008	\$129	RB1HVC	153	5KCP39HGY842S	3916	\$126	RB1HVC	153	5KCP39LGY935S	3S021	\$135	RB1HVC	133
5KCP39GFY917S	3S003	\$137	RB1HVC	148	5KCP39HGY931S	3S017	\$125	RB1HVC	157	5KCP39MG5312S	3891	\$181	RB1HVC	158
5KCP39GG3336S	3481	\$166	RB1HVC	139	5KCP39JFAC97S	3404	\$107	RB1HVC	146	5KCP39MG5313T	3892	\$183	RB1HVC	159
5KCP39GG3338S	3482	\$168	RB1HVC	139	5KCP39JFAD07S 3404HS	\$111	RB1HVC	142	5KCP39MG5438T	3094	\$196	RB1HVC	137	
5KCP39GG3611S	3009	\$160	RB1HVC	155	5KCP39JFBA53S	3204	\$119	RB1HVC	147	5KCP39MGAA36S	3588	\$105	RB1HVD	136
5KCP39GG5606S	3012	\$164	RB1HVM	154	5KCP39JFBA83S 3204HS	\$131	RB1HVC	143	5KCP39MGBB01S	3985	\$107	RB1HVM	135	
5KCP39GG5828S	3671	\$127	RB1HVC	137	5KCP39JFY832S	3917	\$127	RB1HVC	152	5KCP39MGC340S	3214	\$115	RB1HVC	157
5KCP39GG9051T	3882	\$168	RB1HVC	150	5KCP39JFY840S	3914	\$117	RB1HVC	153	5KCP39MGE215S	3996	\$182	RB1HVC	136
5KCP39GGA769S	3028	\$79	RB1HVC	145	5KCP39JFY934S	3S020	\$125	RB1HVC	161	5KCP39MGE931S	3085	\$188	RB1HVC	145
5KCP39GGB158S	3070	\$167	RB1HVC	158	5KCP39JG5831T	3682	\$135	RB1HVC	137	5KCP39MGG403S	3229	\$86	RB1HVC	139
5KCP39GGB907S	3122	\$177	RB1HVC	160	5KCP39JGA406T	3686	\$100	RB1HVC	146	5KCP39MGH613S	3429	\$98	RB1HVC	146
5KCP39GGC124S	3046	\$95	RB1HVC	145	5KCP39JGC337S	3208	\$108	RB1HVC	155	5KCP39MGK209S	3330	\$89	RB1HVD	136
5KCP39GGC521T	3470	\$229	RB1HVC	138	5KCP39JGJ997T	3066	\$134	RB1HVC	150	5KCP39MGL796S	3737	\$129	RB1HVD	146
5KCP39GGD320S	3047	\$132	RB1HVM	151	5KCP39JGN654T	3586	\$87	RB1HVD	136	5KCP39MGP041S	3166	\$149	RB1HVC	146
5KCP39GGN333S	3155	\$114	RB1HVC	158	5KCP39JGP733S	3786	\$114	RB1HVC	137	5KCP39NFAD09S 3405HS	\$116	RB1HVC	143	
5KCP39GGP730S	3783	\$109	RB1HVC	135	5KCP39JGT947S	3282	\$164	RB1HVC	145	5KCP39NFAD13S 3457HS	\$96	RB1HVM	142	
5KCP39GGU714S 3732HS	\$99	RB1HVD	144	5KCP39JGU530S	3458	\$86	RB1HVM	141	5KCP39NFBA51S	3459	\$96	RB1HVM	141	
5KCP39GGY796S 3728HS	\$79	RB1HVD	144	5KCP39KG1369S	3001	\$157	RB1HVM	154	5KCP39NFBA52S	3205	\$124	RB1HVC	147	
5KCP39GGY822S	3906	\$123	RB1HVC	149	5KCP39KG3316T	3281	\$162	RB1HVC	145	5KCP39NFBA66S	3026	\$126	RB1HVC	145
5KCP39GGY826S	3909	\$115	RB1HVC	149	5KCP39KGB906S	3124	\$172	RB1HVM	151	5KCP39NFBA73S	3035	\$161	RB1HVC	145
5KCP39GGY833S	3912	\$133	RB1HVC	152	5KCP39KGB909S	3134	\$151	RB1HVC	148	5KCP39NFBA76S	3209	\$159	RB1HVC	158
5KCP39GGY839S	3915	\$108	RB1HVC	152	5KCP39KGC100T	3128	\$174	RB1HVC	155	5KCP39NFBA78S	3049	\$126	RB1HVC	145
5KCP39GGY845S	3924	\$117	RB1HVC	158	5KCP39KGC519T	3280	\$264	RB1HVC	139	5KCP39NFBA82S 3205HS	\$136	RB1HVC	143	
5KCP39GGY923S	3S009	\$125	RB1HVC	153	5KCP39KGD368S	3091	\$128	RB1HVC	137	5KCP39NFBA87S 3459HS	\$98	RB1HVM	142	
5KCP39GGY929S	3S015	\$117	RB1HVC	157	5KCP39KGU361S	3465	\$88	RB1HVM	141	5KCP39NG5082S	3692	\$158	RB1HVC	146
5KCP39HFAD05S 3403HS	\$97	RB1HVC	142	5KCP39KGV804S	3463	\$96	RB1HVM	140	5KCP39NGA407S	3696	\$118	RB1HVC	146	
5KCP39HFBA79S 3203HS	\$109	RB1HVC	144	5KCP39KGV805S	3464	\$98	RB1HVM	140	5KCP39NGAA44S	3589	\$118	RB1HVD	136	
5KCP39HG7728S	3114	\$172	RB1HVC	148	5KCP39KGY834S	3918	\$158	RB1HVC	159	5KCP39NGC339S	3212	\$113	RB1HVC	157
5KCP39HG9050S	3881	\$166	RB1HVC	150	5KCP39KGY924S	3S010	\$145	RB1HVC	154	5KCP39NGC522S	3490	\$265	RB1HVC	138
5KCP39HGA206S	3123	\$150	RB1HVC	151	5KCP39KGY925S	3S011	\$149	RB1HVC	154	5KCP39NGD123T	3292	\$187	RB1HVC	145
5KCP39HGAA06AS	3385	\$83	RB1HVD	136	5KCP39LFD03S	3405	\$112	RB1HVC	146	5KCP39NGD369S	3092	\$150	RB1HVC	137



GE Commercial Motors

By Regal-Beloit

CATALOG NUMBER CROSS-REFERENCE

Model Number to Catalog Number

Model No.	Cat. No.	List Price	Multiplier Symbol	Page No.	Model No.	Cat. No.	List Price	Multiplier Symbol	Page No.	Model No.	Cat. No.	List Price	Multiplier Symbol	Page No.	
5KCP39NGL571S	3591	\$202	RB1HVC	156	5KCP39RGU706S	3466	\$120	RB1HVM	140	5SME59BLA2039	5201	\$170	RB1E84	133	
5KCP39NGL785S	3032	\$108	RB1HVC	145	5KCP39RGU709S 3460HS	\$108	RB1HVM	143		5SME59BLA2059	5202	\$169	RB1E84	133	
5KCP39NGM437S	3388	\$102	RB1HVD	136	5KCP39RGU718S 3734HS	\$113	RB1HVD	144		5SME59BLA2061	5203	\$169	RB1E84	133	
5KCP39NGP735S	3788	\$132	RB1HVC	137	5KCP39RGU723S 3738HS	\$153	RB1HVD	144		5SME59BLA2069	5220	\$174	RB1E84	171	
5KCP39NGS429S	3030	\$93	RB1HVC	145	5KCP39RGU733S 3468HS	\$112	RB1HVM	143		5SME59BLA2070	5210	\$175	RB1E84	171	
5KCP39NGT583S	3143	\$106	RB1HVC	156	5KCP39RGY787S	3903	\$174	RB1HVC	158		5SME59BLA2071	5211	\$175	RB1E84	171
5KCP39NGU364S	3467	\$124	RB1HVM	140	5KCP39RGY799S 3730HS	\$93	RB1HVD	144		5SME59BLA2072	5221	\$174	RB1E84	172	
5KCP39NGU724S 3737HS	\$139	RB1HVD	144		5KCP39SFAD04S	3746	\$121	RB1HVC	135		5SME59BLA2080	5204	\$175	RB1E84	133
5KCP39NGY813S	3902	\$164	RB1HVC	148	5KCP39SFU729S	3921	\$185	RB1HVC	160		5SME59DVA1004	5106	\$145	RB1E84	133
5KCP39NGY835S	3913	\$153	RB1HVC	154	5KCP39SGH640S	3431	\$132	RB1HVC	146		5SME59DVA1005	5105	\$145	RB1E84	133
5KCP39NGY930S	3S016	\$115	RB1HVC	158	5KCP39SGL762S	3048	\$130	RB1HVC	145		5SME59DVA2006	5206	\$145	RB1E84	171
5KCP39NGY936S	3S022	\$139	RB1HVC	133	5KCP39SGL784S	3430	\$110	RB1HVC	146		5SME59DVA2007	5205	\$145	RB1E84	133
5KCP39PFBA57S	3034	\$211	RB1HVC	145	5KCP39SGL794S	3739	\$173	RB1HVD	135		8794700FSG01	A447	\$100	RB1EACC	169
5KCP39PFM210S	3331	\$108	RB1HVD	136	5KCP39SGL853S	3596	\$182	RB1HVC	136		97F5001	97F5001S	\$7.33	CP03	165
5KCP39PFU680S	3037	\$126	RB1HVC	145	5KCP39SGL854S	3595	\$180	RB1HVC	136		97F5276	97F5276S	\$18.17	CP03	165
5KCP39PFY829S	3919	\$146	RB1HVC	160	5KCP39SGL938S	3735	\$135	RB1HVD	146		97F5388	97F5388S	\$7.46	CP03	164
5KCP39PG5081T	3691	\$160	RB1HVC	146	5KCP39SGS428S	3230	\$95	RB1HVC	156		97F5706	97F5706S	\$5.17	CP03	164
5KCP39PG9701S	3050	\$156	RB1HVC	156	5KCP39SGT039S	3731	\$110	RB1HVD	146		97F6749	97F6749S	\$7.73	CP03	164
5KCP39PGA749T	3103	\$210	RB1HVC	137	5KCP39SGU073S	3288	\$164	RB1HVC	145		97F6755	97F6755S	\$11.36	CP03	164
5KCP39PGA853S	3898	\$215	RB1HVC	149	5KCP39SGU717S 3735HS	\$139	RB1HVD	144		97F6759	97F6759S	\$10.95	CP03	164	
5KCP39PGA854S	3698	\$209	RB1HVC	146	5KCP39SGU725S 3739HS	\$184	RB1HVD	144		97F6763	97F6763S	\$6.65	CP03	164	
5KCP39PGBB07S	3988	\$129	RB1HVM	135	5KCP39SGU732S 3469HS	\$102	RB1HVM	142		97F6766	97F6766S	\$5.81	CP03	164	
5KCP39PGC092S	3005	\$167	RB1HVM	151	5KCP39SGU734S	3925	\$176	RB1HVC	150		97F6823	97F6823S	\$10.45	CP03	164
5KCP39PGC138S	3132	\$177	RB1HVC	150	5KCP39SGY699S	3038	\$112	RB1HVC	145		97F6836	97F6836S	\$15.01	CP03	164
5KCP39PGC520T	3290	\$271	RB1HVM	145	5KCP39SGY805S 3731HS	\$120	RB1HVD	144		97F8036	97F8036S	\$7.76	CP03	165	
5KCP39PGC910S	3067	\$266	RB1HVM	154	5KCP39SGY830S	3922	\$165	RB1HVC	159		97F8037	97F8037S	\$9.81	CP03	165
5KCP39PGE415S	3998	\$202	RB1HVC	136	5KCP39TFAD10S 3746HS	\$125	RB1HVC	144		97F8038	97F8038S	\$10.83	CP03	165	
5KCP39PGE416S	3999	\$204	RB1HVC	136	5KCP39TFBA84S 3747HS	\$145	RB1HVC	144		97F8039	97F8039S	\$11.81	CP03	165	
5KCP39PGE932S	3086	\$210	RB1HVC	145	5KCP39TFBA85S	3740	\$176	RB1HVC	135		97F8040	97F8040S	\$12.79	CP03	165
5KCP39PGL795S	3738	\$146	RB1HVD	146	5KCP39TFBA86S 3461HS	\$120	RB1HVM	143		97F8042	97F8042S	\$14.79	CP03	165	
5KCP39PGL811S	3734	\$106	RB1HVD	146	5SME39DLHE044	5R002	\$230	RB1E23	134		97F8044	97F8044S	\$17.28	CP03	165
5KCP39PGM438S	3387	\$100	RB1HVD	136	5SME39DLHE053	5R004	\$230	RB1E23	134		97F8049	97F8049S	\$23.32	CP03	165
5KCP39PGN091S	3389	\$114	RB1HVD	136	5SME39HLHE043	5R007	\$235	RB1E23	134		97F8050	97F8050S	\$24.26	CP03	165
5KCP39PGN092S	3390	\$116	RB1HVD	136	5SME39HLHE052	5R005	\$235	RB1E23	134		97F8052	97F8052S	\$26.38	CP03	165
5KCP39PGN655S	3587	\$103	RB1HVD	136	5SME39HXL077	6001	\$270	RB1E23	172		97F8053	97F8053S	\$30.15	CP03	165
5KCP39PGN658S	3590	\$120	RB1HVD	136	5SME39HXL095	6002	\$270	RB1E23	164		97F8054	97F8054S	\$4.95	CP03	164
5KCP39PGP734S	3787	\$130	RB1HVC	137	5SME39HXL110	6005	\$325	RB1E23	164		97F8055	97F8055S	\$5.17	CP03	164
5KCP39PGP736S	3789	\$145	RB1HVC	137	5SME39SXL078	6003	\$340	RB1E23	164		97F8056	97F8056S	\$5.50	CP03	164
5KCP39PGP737S	3790	\$147	RB1HVC	137	5SME39SXL096	6004	\$340	RB1E23	164		97F8057	97F8057S	\$5.70	CP03	164
5KCP39PGS511S	3275	\$164	RB1HVC	138	5SME39SXL111	6010	\$410	RB1E23	164		97F8058	97F8058S	\$6.05	CP03	164
5KCP39PGS618S	3730	\$86	RB1HVD	146	5SME59BLA1036	5100	\$170	RB1E84	133		97F8059	97F8059S	\$5.70	CP03	164
5KCP39PGT377S	3760	\$158	RB1HVC	135	5SME59BLA1038	5101	\$170	RB1E84	133		97F8060	97F8060S	\$7.42	CP03	164
5KCP39PGU418S	3469	\$98	RB1HVM	141	5SME59BLA1058	5102	\$169	RB1E84	133		97F8061	97F8061S	\$8.01	CP03	165
5KCP39PGU419S	3468	\$108	RB1HVM	141	5SME59BLA1060	5103	\$169	RB1E84	133		97F8063	97F8063S	\$9.22	CP03	165
5KCP39PGU719S	3901	\$156	RB1HVC	149	5SME59BLA1065	5110	\$175	RB1E84	133		97F8064	97F8064S	\$10.28	CP03	165
5KCP39RFBA75S	3036	\$174	RB1HVC	145	5SME59BLA1066	5111	\$175	RB1E84	133		97F8065	97F8065S	\$11.29	CP03	165
5KCP39RFY828S	3920	\$156	RB1HVC	159	5SME59BLA1067	5121	\$174	RB1E84	133		97F8066	97F8066S	\$12.50	CP03	165
5KCP39RGGBB04AS	3989	\$157	RB1HVM	135	5SME59BLA1068	5120	\$174	RB1E84	133		97F8067	97F8067S	\$13.51	CP03	165
5KCP39RGGBB06S	3990	\$159	RB1HVM	135	5SME59BLA1079	5104	\$175	RB1E84	133		97F8068	97F8068S	\$19.28	CP03	165
5KCP39RGGBB08AS	3987	\$127	RB1HVM	135	5SME59BLA2037	5200	\$170	RB1E84	133		97F8069	97F8069S	\$16.15	CP03	165



GE Commercial Motors

Data subject to change without notice

By Regal-Beloit

CATALOG NUMBER CROSS-REFERENCE

Model Number to Catalog Number

Model No.	Cat. No.	List Price	Multiplier Symbol	Page No.	Model No.	Cat. No.	List Price	Multiplier Symbol	Page No.	Model No.	Cat. No.	List Price	Multiplier Symbol	Page No.
97F8070	97F8070S	\$17.18	CP03	165	PB030E000A440AA	PB030E000A440AAS	\$3.93	CP03	162	PB350E000A370EA	PB350E000A370EAS	\$12.17	CP03	162
97F8071	97F8071S	\$19.45	CP03	165	PB040E000A440AA	PB040E000A440AAS	\$4.41	CP03	162	PB350E000C240DA	PB350E000C240DAS	\$9.54	CP03	162
97F8072	97F8072S	\$20.46	CP03	165	PB050E000A370BA	PB050E000A370AAS	\$4.09	CP03	162	PB350E000C440DA	PB350E000C440DAS	\$19.06	CP03	162
97F8073	97F8073S	\$21.75	CP03	165	PB050E000A440BA	PB050E000A440BAS	\$4.14	CP03	162	PB350Z050S440EA	PB350Z050S440EAS	\$19.85	CP03	163
97F9002	97F9002S	\$5.97	CP03	164	PB060E000A370BA	PB060E000A370BAS	\$4.69	CP03	162	PB400E000C370DA	PB400E000C370DAS	\$16.57	CP03	162
97F9010	97F9010S	\$16.04	CP03	165	PB060E000A440BA	PB060E000A440BAS	\$4.47	CP03	162	PB400E000C440DA	PB400E000C440DAS	\$20.38	CP03	162
97F9011	97F9011S	\$19.25	CP03	165	PB075E000A370BA	PB075E000A370BAS	\$4.57	CP03	162	PB450E000C370DA	PB450E000C370DAS	\$20.20	CP03	162
97F9012	97F9012S	\$20.53	CP03	165	PB075E000A440CA	PB075E000A440CAS	\$5.35	CP03	162	PB450E000C440EA	PB450E000C440EAS	\$13.27	CP03	162
97F9602	97F9602S	\$8.25	CP03	165	PB100E000A370CA	PB100E000A370CAS	\$5.09	CP03	162	PB450Z050T440DA	PB450Z050T440DAS	\$24.07	CP03	163
97F9606	97F9606S	\$9.12	CP03	165	PB100E000A440CA	PB100E000A440CAS	\$5.55	CP03	162	PB500E000C370DA	PB500E000C370DAS	\$15.31	CP03	162
97F9608	97F9608S	\$10.08	CP03	165	PB125E000A370CA	PB125E000A370CAS	\$5.50	CP03	162	PB550E000D440EA	PB550E000D440EAS	\$26.68	CP03	162
97F9613	97F9613S	\$16.68	CP03	165	PB125E000A440DA	PB125E000A440DAS	\$6.57	CP03	162	PB550Z075T440EA	PB550Z075T440EAS	\$29.65	CP03	163
97F9614	97F9614S	\$12.03	CP03	165	PB125E000P440CA	PB125E000P440CAS	\$6.63	CP03	163	PB600E000D440HA	PB600E000D440HAS	\$16.91	CP03	162
97F9625	97F9625S	\$7.51	CP03	165	PB150E000A370CA	PB150E000A370CAS	\$6.09	CP03	162	RPHXL110P0133	6005CTL	\$200	RB1E23	164
97F9626	97F9626S	\$7.13	CP03	165	PB150E000A440EA	PB150E000A440EAS	\$6.69	CP03	162	RPSXL111P0134	6010CTL	\$250	RB1E23	164
97F9632	97F9632S	\$10.01	CP03	165	PB150E000P440CA	PB150E000P440CAS	\$6.67	CP03	163	SSC2B12CSHBV1	5R024	\$106	RB1E84	165
97F9635	97F9635S	\$11.01	CP03	165	PB175E000A370DA	PB175E000A370DAS	\$7.68	CP03	162	SSC2B12CSHEMA1	5R016	\$86	RB1E84	134
97F9638	97F9638S	\$20.28	CP03	164	PB200E000A370DA	PB200E000A370DAS	\$7.25	CP03	162	SSC2B12CSHEMV1	5R025	\$85	RB1E84	164
97F9802	97F9802S	\$14.36	CP03	165	PB200E000A440EA	PB200E000A440EAS	\$7.80	CP03	162	SSC2B13CSHEMA1	5R020	\$88	RB1E84	134
97F9815	97F9815S	\$29.48	CP03	165	PB200E000P440CA	PB200E000P440CAS	\$6.69	CP03	163	SSC2B15CSHEMA2	5R019	\$100	RB1E84	134
97F9834	97F9834S	\$19.48	CP03	165	PB250E000A370DA	PB250E000A370DAS	\$11.31	CP03	162	SSC2B16CSHEMA1	5R021	\$90	RB1E84	172
97F9848	97F9848S	\$21.12	CP03	165	PB250E000A440EA	PB250E000A440EAS	\$7.45	CP03	162	SSC2B18AHEMAR1	5R017	\$92	RB1E84	134
97F9849	97F9849S	\$20.28	CP03	165	PB250E000P440DA	PB250E000P440DAS	\$9.12	CP03	163	SSC2B18AHEMAR1	5R022	\$98	RB1E84	172
97F9851	97F9851S	\$26.74	CP03	165	PB250Z050S440DA	PB250Z050S440DAS	\$16.68	CP03	163	SSC2B19AHEMAR2	5R018	\$106	RB1E84	134
97F9874	97F9874S	\$31.54	CP03	165	PB300E000A370EA	PB300E000A370EAS	\$9.55	CP03	162	SSC2B19AHEMAR2	5R023	\$112	RB1E84	165
97F9884	97F9884S	\$13.48	CP03	165	PB300E000C240CA	PB300E000C240CAS	\$7.93	CP03	162					
97F9970	97F9970S	\$23.09	CP03	165	PB300E000C440DA	PB300E000C440DAS	\$17.70	CP03	162					
97F9978	97F9978S	\$17.75	CP03	165	PB300E000P440DA	PB300E000P440DAS	\$10.30	CP03	163					



GE Commercial Motors

By Regal-Beloit

MOTOR WARNINGS & CAUTIONS



IMPORTANT INFORMATION

Please Read Carefully



This catalog is not intended to provide operational instructions. Appropriate GE Commercial Motors by Regal-Beloit instructions provided with the motor and precautions attached to the motor should be read carefully prior to installation, operation and/or maintenance of the equipment. Injury to personnel or motor failure may be caused by improper installation, maintenance or operation.

The following  and  information is supplied to you for your protection and to provide you with many years of trouble free and safe operation of your GE Commercial Motors by Regal-Beloit product:



- Disconnect power and lock out driven equipment before working on a motor.
- Always keep hands and clothing away from moving parts.
- The lifting support on the motor is not to be used to lift the entire machine. Only the motor attached directly to the support may be safely lifted by the support.
- Install and ground per local and national codes.
- Discharge all capacitors before servicing a single phase motor.
- Misapplication of a motor in a hazardous environment can cause fire or an explosion and result in serious injury. Only the end user, local authority having jurisdiction, and/or insurance underwriter are qualified to identify the appropriate class(es), group(s), division and temperature code. GE Commercial Motors by Regal-Beloit personnel can not evaluate or recommend what motors may be suitable for use in hazardous environments. If a motor is nameplated for hazardous locations, do not operate the motor without all of the grease and drain plugs installed.
- Never attempt to measure the temperature rise of a motor by touch. Temperature rise must be measured by thermometer, resistance, imbedded detector or thermo-couple.
- Motors with automatic reset thermal protectors will automatically restart when the protector temperature drops sufficiently. Do not use motors with automatic reset thermal protectors in applications where automatic restart will be hazardous to personnel or equipment.
- Motors with manual reset thermal protectors may start unexpectedly after the protector trips when the surrounding air is at +20°Fahrenheit or lower. If the manual reset protector trips, disconnect motor from its power supply. After the protector cools (five minutes or more), it can be reset and power may be applied to the motor.
- Connect all protective device leads, marked P1, P2, etc., per instructions supplied with the motor.
- Operation of a motor at other than its nameplate rating may result in fire, damage to equipment or serious injury to personnel.
- For safety, Buyer or User should provide protective guards over all shaft extensions and any moving apparatus mounted thereon. The User is responsible for checking all applicable safety codes in his area and providing suitable guards. Failure to do so may result in bodily injury and/or damage to equipment.



- Consult qualified personnel with questions and all electrical repairs must be performed by trained and qualified personnel only.
- For motors nameplated as "belted duty only", do not operate the motor without belts properly installed.
- Motors and/or driven equipment should not be operated faster than their rated speed.
- For inverter applications, follow the inverter manufacturer's installation guidelines.
- Make sure the motor is properly secured and aligned before operation.

IMPORTANT INFORMATION

Resale of Goods

In the event of the resale of any of the goods, in whatever form, Resellers/Buyers will include the following language in a conspicuous place and in a conspicuous manner in a written agreement covering such sale:

The manufacturer makes no warranty or representations, express or implied, by operation of law or otherwise, as to the merchantability or fitness for a particular purpose of the goods sold hereunder. Buyer acknowledges that it alone has determined that the goods purchased hereunder will suitably meet the requirements of their intended use. In no event will the manufacturer be liable for consequential, incidental or other damages. Even if the repair or replacement remedy shall be deemed to have failed of its essential purpose under Section 2-719 of the Uniform Commercial Code, the manufacturer shall have no liability to Buyer for consequential damages.

Resellers/Buyers agree to also include this entire document including the warnings and cautions above in a conspicuous place and in a conspicuous manner in writing to instruct users on the safe usage of the product.

This information should be read together with all other printed information supplied by Marathon Electric.

For more information contact: RBC Manufacturing Corporation, Subsidiary of Regal-Beloit Corporation, 100 E. Randolph St., Wausau, WI 54401
Phone: 715-675-3311 or Fax: 715-675-8030.



GE Commercial Motors

By Regal-Beloit

NOTES

Note #	Description
1	5/8" shaft adapter
2	6" shaft extension with 2 flats 90° apart
3	Capacitor supplied with motor
4	Sleeve bearing
5	Designed for 60° C ambient
6	Designed for 65° C ambient
7	Length adapter kit included
8	Mounting accessories and resilient ring for pulley end are not included. Opposite shaft-end endshield is open. Use accessory kit 161L131AB1 for resilient ring mounting.
9	Opposite shaft-end endshield is open
10	Shaft-endshield is open
11	Shaft extension 3/8" diameter
12	Designed for 50 or 60 Hz operation
13	TENV construction
14	Ball bearing

Dimension:

A	Shaft length on lead end
B	Shaft length opposite lead end
C	Overall length of motor including shaft
YO	Distance between the outer edges of the mounting grooves for the cushion ring

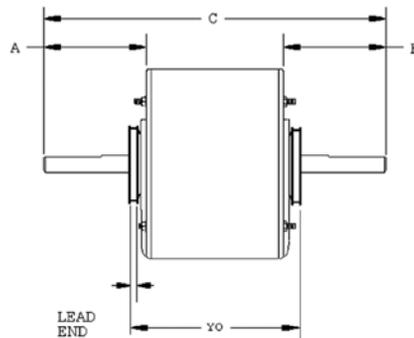

GE Commercial Motors

By Regal-Beloit

With 22 years of experience designing and refining ECM products, genteq introduces the commercial refrigeration industry's first 3.3" ECM



Features and Benefits

- Mounting features are interchangeable with standard shaded pole and PSC motors, which makes for quick and easy installation
- Up to 2 line voltage enable discrete speeds
- Offers up to 65% greater efficiency than a shaded-pole motor, and up to 40% greater efficiency than a PSC motor
- ECM Toolbox Software lets manufacturers quickly and easily create motor programming
- Regulated speed mode helps maintain even temperatures for fresher, longer-lasting food

Applications

- Designed for condenser and evaporator fans for walk-in refrigerators, walk-in freezers, and similar applications

For further details, see catalog page 133.



morrillmotors®



GE Commercial Motors

By Regal-Beloit

Save Fuel Costs with PROLINE™ Capacitors!



PROLINE™ Capacitors are the new quality line developed by genteq™ for budget minded contractors. PROLINE™ delivers genteq™ PROVEN 10K hrs reliability performance* while costing you less than premium brands.

Use PROLINE™ quality parts the first time - save fuel and time by reducing costly repeat visits.

* Proven IEC-252 Class B Industry Standard Compliancy (simulates 10,000 hours of field life).

Save Time and Money with Life-Line™ Capacitor Kit!

The Life-Line™ Capacitor Kit can save you time and money by having the exact capacitor rating that you need for the job. Not only does this kit provide you the ability to use and replace the parts you need but the overall solution cost is more economical than the competitions.

This kit has been designed to cover over 85% of the most commonly used capacitor ratings in the field today.

Turn six capacitors into 48 different ratings, with no guess work by using the UL approved (patent-pending) Life-Line™ “Spider” Device.



Now that is savings you can hold in your hand!



Ask your FASCO Authorized Distributor how you can start saving today!

FASCO

1401 East North Street
Eldon, MO 65026
1-800-325-8313
Fax 1-800-352-7207
www.fasco.com

6802FS-SK-2/11-35K-HP

FASCO is a trademark of Regal Beloit Corporation.

